

Datasheet | S32411

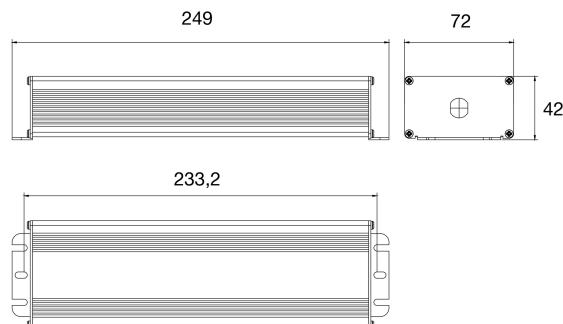

SLC Driver 48V 200W Alu Trailing edge IP67

SLC Driver 48V 200W in aluminium, trailing-edge dimmable, IP67. A robust driver for LED strips, suitable for both indoor and outdoor use. Filter S59010 is included in the package.

Electrical

Input	220-240V 50/60Hz
Technology	Constant voltage (CV)
Voltage out	48V DC
Rated power	200 W
Power (W) multi	66-200 W
Power factor	0.95
Current out multi	1,38-4,16A
Control type	Trailing edge
Dimming output	PWM - Pulse Width Modulation
MAX. qty on 16A Circuit Breaker (Type C)	7
Connection	30 cm cable with free ends on both sides
Operating temperature (Ta)	-20°C ~ +50°C
Insulation class	Class I
SELV	Yes
Colour Control	Mono color
Reverse voltage protection	Yes

Mechanical

Material, main	Aluminium
IP rating	IP67
Colour	Alu
Suitable for	Indoor / Outdoor
Tc	80 °C

Dimensions

Height	40 mm
Width	72 mm
Length	249 mm
Product net weight	1250 g