

1625010001

ZPL CL.04 WING NT LIGHT (AM) M10

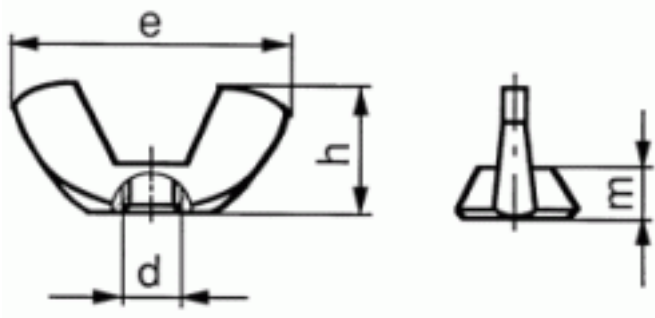

Brand	-
UBB Code	950355162856
UNSPSC Code	31161717
EAN Code	8715492590343
Thread	Metric thread
Class	04
Material	Steel
Surface treatment	Zinc plated
Driving features	wing



h ≈	17,3
e ≈	35,3
m ≈	6,3
P	1,5
d	M10
Packaging (Piece)	100.0



Copyright Fabory Group