

51810080001

STNL A2 WING NT LIGHT (AM) M8

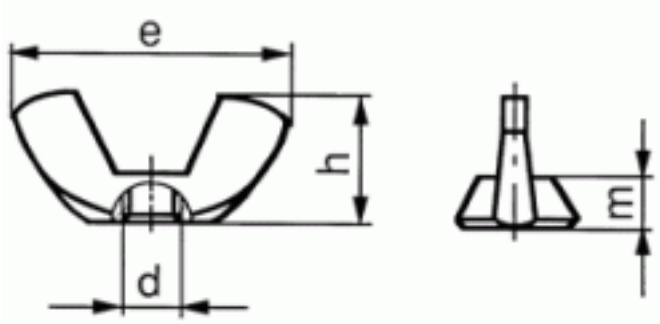

Brand	-
UBB Code	950355229606
UNSPSC Code	31161717
EAN Code	8715492310521
Driving features	wing
Thread	Metric thread
Material	Stainless steel
Material technical	A2



h ≈	14,8
e ≈	30,3
m ≈	5,4
P	1,25
d	M8
Packaging (Piece )	50.0



Copyright Fabory Group