

Driver LC 75W 1100-1400mA flexC Ip SNC4

essence series



Product description

- _ Constant current LED driver for luminaire installation
- _ 3 pin DIP switch version valid from production date: 20.12.2024
- _ For luminaires of protection class I and protection class II
- _ Temperature protection as per EN 61347-2-13 C5e
- _ Selectable fixed output current 1,100, 1,150, 1,200, 1,250, 1,300, 1,350 and 1,400 mA (pre-selected current 1,400 mA)
- _ Max. output power 75.6 W
- _ Up to 89 % efficiency
- _ Nominal lifetime up to 100,000 h
- _ 5 years guarantee (conditions at <https://www.tridonic.com/en/int/services/manufacturer-guarantee-conditions>)

Housing properties

- _ Casing: metal, white
- _ Type of protection IP20

Functions

- _ Overload protection
- _ Short-circuit protection
- _ No-load protection

Website

<http://www.tridonic.com/28004144>

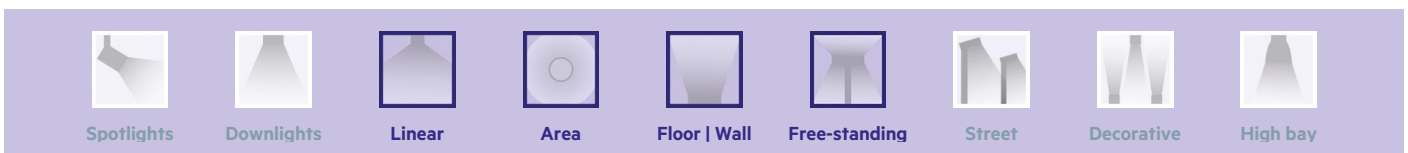
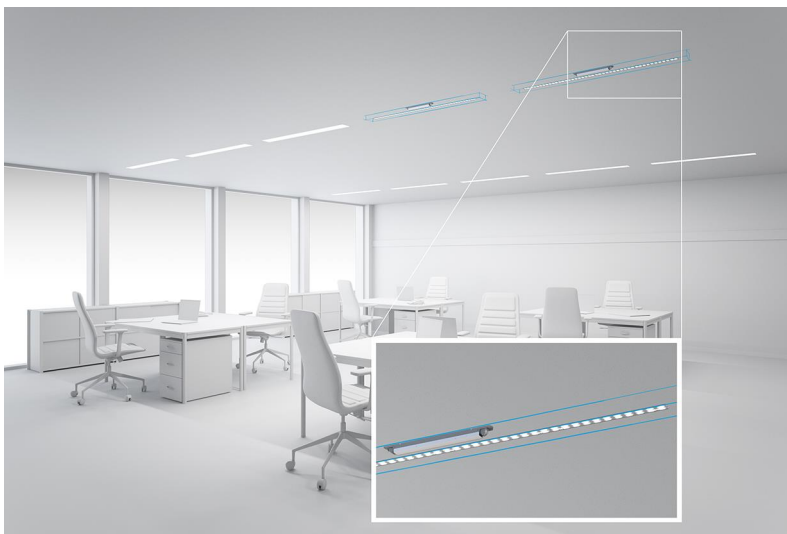

Driver LC 75W 1100-1400mA flexC Ip SNC4

essence series

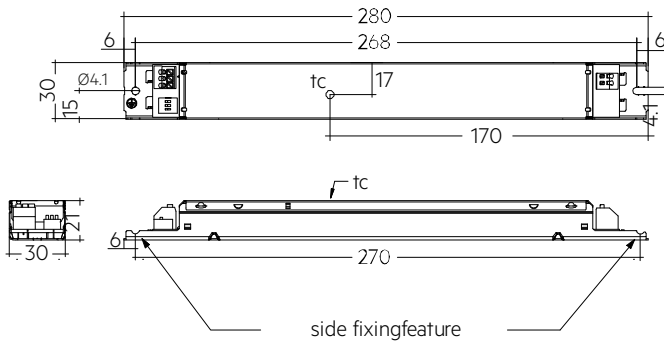

Ordering data

Type	Article number	Packaging, carton	Packaging, pallet	Weight per pc.
LC 75/1100-1400/54 flexC Ip SNC4	28004144	50 pc(s).	3,600 pc(s).	0.215 kg

Technical data

Rated supply voltage	220 – 240 V
AC voltage range	198 – 264 V
DC voltage range	176 – 280 V
Max. input current (at 230 V, 50 Hz, full load) ^①	0.37 A
Leakage current (at 230 V, 50 Hz, full load)	< 450 µA
Touch current (equipotential connected) ^②	450 µA
Mains frequency	0 / 50 / 60 Hz
Overvoltage protection	320 V AC, 2 h
Max. output power	75 W
Output power range	22 – 75.6 W
Typ. efficiency (at 230 V, 50 Hz, full load) ^①	89 %
λ over full operating range (max.) ^①	0.98
λ over full operating range (min.)	0.92C
Output current tolerance ^③	± 7.5 %
Max. output voltage (U-OUT)	60 V
THD (at 230 V, 50 Hz, full load) ^①	< 15 %
Max. peak output current at full load ^①	1,580 mA
Output LF current ripple (< 120 Hz) at full load	± 5 %
Output P_ST_LM (at full load)	≤ 1
Output SVM (at full load)	≤ 0.4
Starting time (at 230 V, 50 Hz, full load)	≤ 0.5 s
Starting time (DC mode)	≤ 0.6 s
Switchover time (AC/DC)	≤ 0.6 s
Turn off time (at 230 V, 50 Hz, full load)	≤ 0.5 s
Hold on time at power failure (output)	0 s
Ambient temperature ta (at lifetime 50,000 h)	50 °C
Storage temperature ts	-40 ... +80 °C
Mains burst capability	1 kV
Mains surge capability (between L - N)	1 kV
Mains surge capability (between L/N - PE)	2 kV
Surge voltage at output side (against PE)	3 kV
Lifetime	up to 100,000 h
Guarantee (conditions at www.tridonic.com)	5 Year(s)
Dimensions L x W x H	280 x 30 x 21 mm
Hole spacing D	270 mm

Approval marks



Standards

EN 55015, EN 61000-3-2, EN 61000-3-3, EN 61000-4-4, EN 61000-4-5, EN 61347-1, EN 61347-2-13, EN 61547, EN 62384, according to EN 50172, according to EN 60598-2-22

Specific technical data

Type	Output current ^①	Min. output voltage	Max. output voltage	Max. output power	Typ. power consumption (at 230 V, 50 Hz, full load)	Typ. current consumption (at 230 V, 50 Hz, full load)	T _c point max.	Ambient temperature T _a	I-out select
LC 75/1100-1400/54 flexC Ip SNC4	1,100 mA	20 V	54 V	59.4 W	65.8 W	290 mA	85 °C	-20 ... +60 °C	1=on / 2=off / 3=off
LC 75/1100-1400/54 flexC Ip SNC4	1,150 mA	20 V	54 V	62.1 W	69.0 W	301 mA	85 °C	-20 ... +60 °C	1=off / 2=on / 3=off
LC 75/1100-1400/54 flexC Ip SNC4	1,200 mA	20 V	54 V	64.8 W	72.0 W	317 mA	85 °C	-20 ... +60 °C	1=on / 2=on / 3=off
LC 75/1100-1400/54 flexC Ip SNC4	1,250 mA	20 V	54 V	67.5 W	75.3 W	331 mA	90 °C	-20 ... +60 °C	1=off / 2=off / 3=on
LC 75/1100-1400/54 flexC Ip SNC4	1,300 mA	20 V	54 V	70.2 W	78.3 W	344 mA	90 °C	-20 ... +60 °C	1=on / 2=off / 3=on
LC 75/1100-1400/54 flexC Ip SNC4	1,350 mA	20 V	54 V	72.9 W	81.4 W	355 mA	90 °C	-20 ... +60 °C	1=off / 2=on / 3=on
LC 75/1100-1400/54 flexC Ip SNC4	1,400 mA	20 V	54 V	75.6 W	84.4 W	370 mA	90 °C	-20 ... +60 °C	1=on / 2=on / 3=on

① Test result at 1,400 mA.

② Maximum of "perception and reaction" and "let go" values according to EN 60598-1.

③ Test result at 25 °C.

④ Output current is mean value.

1. Standards

EN 55015
 EN 61000-3-2
 EN 61000-3-3
 EN 61000-4-4
 EN 61000-4-5
 EN 61347-1
 EN 61347-2-13
 EN 61547
 EN 62384

According to EN 50172 for use in central battery systems

According to EN 60598-2-22 suitable for emergency lighting installations

2. Thermal details and lifetime

Expected lifetime					
Type	Output current	ta	40 °C	50 °C	60 °C
	1,100 mA	tc	65 °C	75 °C	85 °C
		Lifetime	> 100,000 h	> 100,000 h	65,000 h
	1,150 mA	tc	65 °C	75 °C	85 °C
		Lifetime	> 100,000 h	> 100,000 h	60,000 h
	1,200 mA	tc	65 °C	75 °C	85 °C
		Lifetime	> 100,000 h	> 100,000 h	50,000 h
LC 75/1100-1400/54 flexC Ip SNC4	1,250 mA	tc	70 °C	80 °C	90 °C
		Lifetime	> 100,000 h	> 100,000 h	50,000 h
	1,300 mA	tc	70 °C	80 °C	90 °C
		Lifetime	> 100,000 h	100,000 h	50,000 h
	1,350 mA	tc	70 °C	80 °C	90 °C
		Lifetime	> 100,000 h	90,000 h	45,000 h
	1,400 mA	tc	70 °C	80 °C	90 °C
		Lifetime	> 100,000 h	65,000 h	30,000 h

The LED driver is designed for a lifetime stated above under reference conditions and with a failure probability of less than 10 %.

The relation of tc to ta temperature depends also on the luminaire design.

If the measured tc temperature is approx. 5 K below tc max., ta temperature should be checked and eventually critical components (e.g. ELCAP) measured. Detailed information on request.

3. Installation / wiring

3.1 Circuit diagram

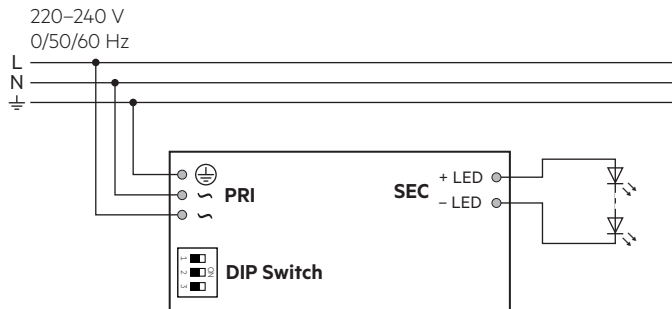

3.2 Wiring type and cross section

For wiring use stranded wire with ferrules or solid wire from 0.5 – 1.5 mm². Strip 8.5 – 9.5 mm of insulation from the cables to ensure perfect operation of the push-wire terminals.



3.3 Release of the wiring

Press down the “push button” and remove the cable from front.

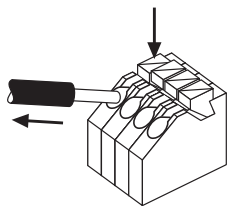

3.4 Wiring guidelines

- All connections must be kept as short as possible to ensure good EMI behaviour.
- Mains leads should be kept apart from LED driver and other leads (ideally 5 – 10 cm distance)
- Max. length of output wires is 2 m.
- Incorrect wiring can damage LED modules.
- To avoid damage of the Driver, the wiring must be protected against short circuits to earth (sharp edged metal parts, metal cable clips, louver, etc.).

3.5 Earth connection

The earth connection is conducted as protection earth (PE). The LED driver can be earthed via metal housing. Ground the LED driver with protective earth (PE).

- Electromagnetic interferences (EMI)
- Transmission of mains transients to the LED output

In general it is recommended to earth the LED driver if the LED module is mounted on earthed luminaire parts respectively heat sinks and thereby representing a high capacity against earth.

3.6 Replace LED module

1. Mains off
2. Remove LED module
3. Wait for 30 seconds
4. Connect LED module again

Hot plug-in or output switching of LEDs is not permitted and may cause a very high current to the LEDs.

3.7 Mounting of device

Max. torque for fixing: 0.5 Nm/M4

3.8 Current setting



Set the current by DIP switch after mains off.
Use of DIP switch only after mains off.

1,100 mA: Switch 1 = On, Switch 2 = Off, Switch 3 = Off

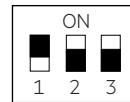

1,150 mA: Switch 1 = Off, Switch 2 = On, Switch 3 = Off

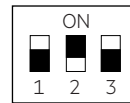

1,200 mA: Switch 1 = On, Switch 2 = On, Switch 3 = Off

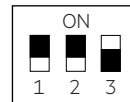

1,250 mA: Switch 1 = Off, Switch 2 = Off, Switch 3 = On

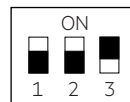

1,300 mA: Switch 1 = On, Switch 2 = Off, Switch 3 = On

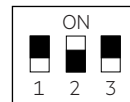

1,350 mA: Switch 1 = Off, Switch 2 = On, Switch 3 = On

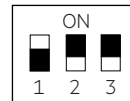

1,400 mA: Switch 1 = On, Switch 2 = On, Switch 3 = On

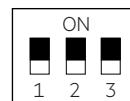

4. Electrical values

4.1 Efficiency vs load

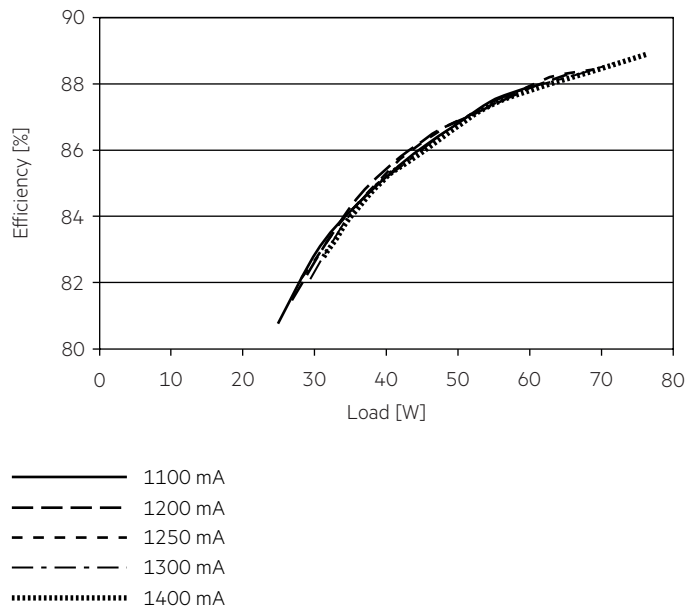

4.2 Power factor vs load

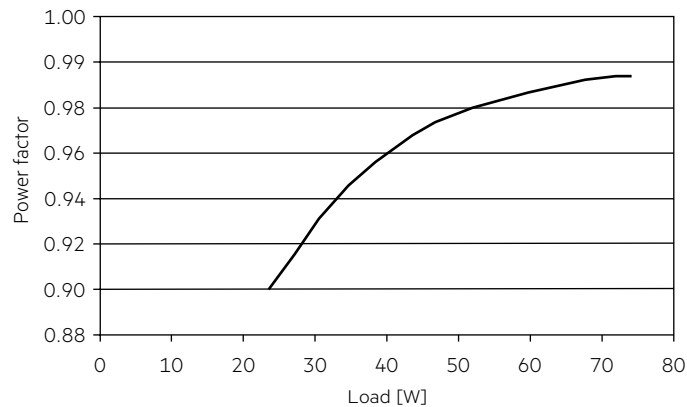

4.3 THD vs load

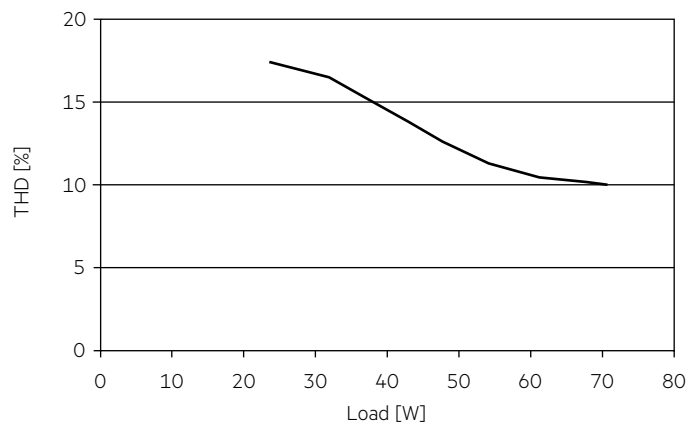

4.4 Maximum loading of automatic circuit breakers

Automatic circuit breaker type	C10	C13	C16	C20	B10	B13	B16	B20	Inrush current	
Installation Ø	1.5 mm ²	1.5 mm ²	2.5 mm ²	2.5 mm ²	1.5 mm ²	1.5 mm ²	2.5 mm ²	2.5 mm ²	I _{max}	Time
LC 75/1100-1400/54 flexC Ip SNC4	18	24	30	38	18	24	30	38	24 A	120 µs

These are max. values calculated out of continuous current running the device on full load. There is no limitation due to in-rush current. If load is smaller than full load for calculation only continuous current has to be considered.

4.5 Harmonic distortion in the mains supply (at 230 V / 50 Hz and full load) in %

	THD	3.	5.	7.	9.	11.
LC 75/1100-1400/54 flexC Ip SNC4	< 15	< 11	< 4	< 5	< 3	< 2

Acc. to 61000-3-2. Harmonics < 5 mA or < 0.6 % (whatever is greater) of the input current are not considered for calculation of THD.

5. Functions

5.1 Short-circuit behaviour

In case of a short circuit on the output side (LED) the LED driver switches off. After elimination of the short-circuit fault the LED driver will recover automatically.

5.2 No-load operation

The LED driver works in burst working mode to provide a constant output voltage regulation which allows the application to be able to work safely when LED string opens due to a failure.

5.3 Overload protection

If the maximum load is exceeded by a defined internal limit, the LED driver will protect itself and LED may flicker. After elimination of the overload, the nominal operation is restored automatically.

5.4 DC emergency operation

The LED driver is designed to operate on DC voltage and pulsed DC voltage. For a reliable operation, make sure that also in DC emergency operation the LED driver is run within the specified conditions.

Light output level in DC operation (E_{OF,DC}): 95 % (cannot be adjusted)

The voltage-dependent input current of Driver incl. LED module is depending on the used load.

The voltage-dependent no-load current of Driver (without or defect LED module) is for:

AC: < 22 mA

DC: < 25 mA

6. Miscellaneous

6.1 Insulation and electric strength testing of luminaires

Electronic devices can be damaged by high voltage. This has to be considered during the routine testing of the luminaires in production.

According to IEC 60598-1 Annex Q (informative only!) or ENEC 303-Annex A, each luminaire should be submitted to an insulation test with 500 V_{DC} for 1 second. This test voltage should be connected between the interconnected phase and neutral terminals and the earth terminal.

The insulation resistance must be at least 2 MΩ.

As an alternative, IEC 60598-1 Annex Q describes a test of the electrical strength with 1500 V_{AC} (or 1.414 x 1500 V_{DC}). To avoid damage to the electronic devices this test must not be conducted.

6.2 Conditions of use and storage

Humidity: 5 % up to max. 85%,
not condensed
(max. 56 days/year at 85%)

Storage temperature: -40 °C up to max. +80 °C

The devices have to be within the specified temperature range (t_a) before they can be operated.

The LED driver is declared as inbuilt LED controlgear, meaning it is intended to be used within a luminaire enclosure.

If the product is used outside a luminaire, the installation must provide suitable protection for people and environment (e.g. in illuminated ceilings).

6.3 Maximum number of switching cycles

All LED driver are tested with 50,000 switching cycles.

6.4 Additional information

Additional technical information at www.tridonic.com → Technical Data

Lifetime declarations are informative and represent no warranty claim. No warranty if device was opened.