

PLC-RSC- 24DC/21-21 - Relay Module



2967060

<https://www.phoenixcontact.com/gb/products/2967060>

Please be informed that the data shown in this PDF document is generated from our online catalog. Please find the complete data in the user documentation. Our general terms of use for downloads are valid.



PLC-INTERFACE, consisting of basic terminal block PLC-BSC.../21 with screw connection and plug-in miniature relay with power contact, for assembly on DIN rail NS 35/7,5, 2 changeover contacts, input voltage 24 V DC

Your advantages

- Slim design
- Efficient connection to system cabling using V8 adapter
- RT III sealed relay
- Safe isolation between coil and contact side
- Functional plug-in bridges
- Integrated input circuit and interference suppression circuit

Commercial data

| | |
|--------------------------------------|---------------------|
| Item number | 2967060 |
| Packing unit | 10 pc |
| Minimum order quantity | 10 pc |
| Sales key | CK621C |
| Product key | CK621C |
| Catalog page | Page 366 (C-5-2019) |
| GTIN | 4017918156374 |
| Weight per piece (including packing) | 74.5 g |
| Weight per piece (excluding packing) | 72.4 g |
| Customs tariff number | 85364190 |
| Country of origin | DE |

PLC-RSC- 24DC/21-21 - Relay Module



2967060

<https://www.phoenixcontact.com/gb/products/2967060>

Technical data

Product properties

| | |
|-------------------------|---------------------------|
| Product type | Relay Module |
| Product family | PLC-INTERFACE |
| Application | Universal |
| Operating mode | 100% operating factor |
| Mechanical service life | 3x 10 ⁷ cycles |

Insulation characteristics

| | |
|------------|---|
| Insulation | Safe isolation: Control side / contact side |
|------------|---|

Insulation characteristics

| | |
|----------------------|---|
| Insulation | Safe isolation: Control side / contact side |
| Overvoltage category | III |
| Pollution degree | 3 |

Electrical properties

| | |
|--|--|
| Maximum power dissipation for nominal condition | 0.43 W |
| Test voltage (Winding/contact) | 4 kV AC (50 Hz, 1 min., winding/contact) |
| Test voltage (Changeover contact/changeover contact) | 2.5 kV AC (50 Hz, 1 min., changeover contact/changeover contact) |
| Rated surge voltage | 6 kV |

Input data

Coil side

| | |
|--------------------------------|--|
| Nominal input voltage U_N | 24 V DC |
| Input voltage range | 20.2 V DC ... 33.6 V DC (20 °C) |
| Drive and function | monostable |
| Drive (polarity) | polarized |
| Typical input current at U_N | 18 mA |
| Typical response time | 8 ms |
| Typical release time | 10 ms |
| Protective circuit | Reverse polarity protection; Polarity protection diode Freewheeling diode; Freewheeling diode |
| Operating voltage display | Yellow LED |

Output data

Switching

| | |
|---------------------------|---|
| Contact switching type | 2 changeover contacts |
| Type of switch contact | Single contact |
| Contact material | AgNi |
| Maximum switching voltage | 250 V AC/DC (The separating plate PLC-ATP should be installed for voltages larger than 250 V (L1, L2, L3) between identical |

PLC-RSC- 24DC/21-21 - Relay Module



2967060

<https://www.phoenixcontact.com/gb/products/2967060>

| | |
|---------------------------------------|---|
| | terminal blocks in adjacent modules. Potential bridging is then carried out with FBST 8-PLC... or ...FBST 500...) |
| Minimum switching voltage | 5 V AC/DC (10 mA) |
| Limiting continuous current | 6 A |
| Maximum inrush current | 15 A (300 ms) |
| Min. switching current | 10 mA (5 V) |
| Interrupting rating (ohmic load) max. | 140 W (at 24 V DC) |
| | 85 W (at 48 V DC) |
| | 60 W (at 60 V DC) |
| | 44 W (at 110 V DC) |
| | 60 W (at 220 V DC) |
| | 1500 VA (for 250 V AC) |
| Switching capacity | 2 A (at 24 V, DC13) |
| | 3 A (at 24 V, AC15) |
| | 3 A (at 120 V, AC15) |
| | 0.2 A (at 250 V, DC13) |
| | 3 A (at 250 V, AC15) |

Connection data

| | |
|----------------------------------|---|
| Cross section AWG | (converted acc. to IEC) |
| Connection method | Screw connection |
| Stripping length | 8 mm |
| Screw thread | M3 |
| Conductor cross section rigid | 0.14 mm ² ... 2.5 mm ² |
| Conductor cross section flexible | 0.14 mm ² ... 2.5 mm ² |
| | 0.2 mm ² ... 2.5 mm ² (Single ferrule) |
| | 2x 0.5 mm ² ... 1.5 mm ² (TWIN ferrule) |
| Conductor cross section AWG | 26 ... 14 |
| Tightening torque | 0.6 Nm ... 0.8 Nm |

Dimensions

| | |
|--------|-------|
| Width | 14 mm |
| Height | 80 mm |
| Depth | 94 mm |

Material specifications

| | |
|--|--------------|
| Flammability rating according to UL 94 | V0 (Housing) |
|--|--------------|

Environmental and real-life conditions

Ambient conditions

| | |
|---|-------------------|
| Degree of protection (Relay) | RT III (Relay) |
| Degree of protection (Relay base) | IP20 (Relay base) |
| Ambient temperature (operation) | -40 °C ... 60 °C |
| Ambient temperature (storage/transport) | -40 °C ... 85 °C |

PLC-RSC- 24DC/21-21 - Relay Module



2967060

<https://www.phoenixcontact.com/gb/products/2967060>

Approvals

CE

| | |
|-------------|--------------|
| Certificate | CE-compliant |
|-------------|--------------|

UKCA

| | |
|-------------|----------------|
| Certificate | UKCA-compliant |
|-------------|----------------|

Shipbuilding approval

| | |
|-------------|------------|
| Certificate | TAE0000196 |
|-------------|------------|

Corrosive gas test

| | |
|----------------|----------------------------|
| Identification | ISA-S71.04. G3 Harsh Group |
| | EN 60068-2-60 |

DNV GL data

| | |
|-------------|---|
| Temperature | D |
| Humidity | A |
| Vibration | B/C |
| EMC | B |
| Enclosure | Required protection according to the Rules shall be provided upon installation on board |

EMC data

| | |
|-------------------------------|--|
| Low Voltage Directive | Conformance with Low Voltage Directive |
| Electromagnetic compatibility | Conformance with EMC directive |

Standards and regulations

| | |
|-----------------------|---------------|
| Standards/regulations | IEC 60947-5-1 |
|-----------------------|---------------|

Mounting

| | |
|-----------------------|---------------------------|
| Mounting type | DIN rail mounting |
| Assembly instructions | in rows with zero spacing |
| Mounting position | any |

Drawings

Diagram

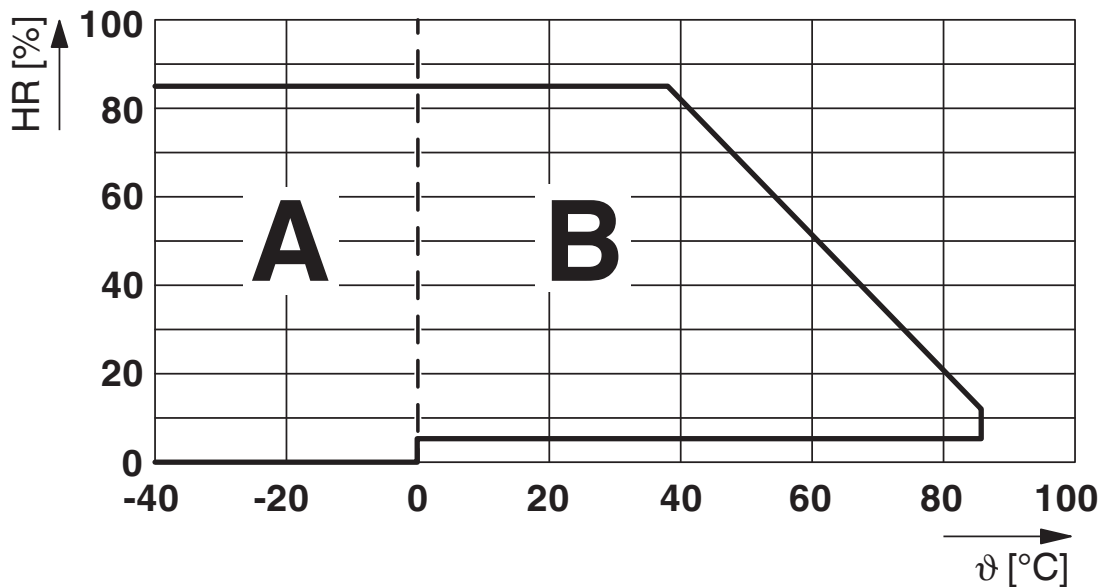

Permissible humidity for operation and storage.

The maximum permissible ambient temperature as specified in the data sheet must be observed.

Area A: Ice buildup at ambient temperatures $\leq 0^\circ\text{C}$ must be prevented

Area B: Condensation at ambient temperatures $> 0^\circ\text{C}$ must be prevented

On 30 full days that are naturally distributed across an entire year, a humidity level of 95% is permissible at an ambient temperature $\leq 25^\circ\text{C}$.

Circuit diagram

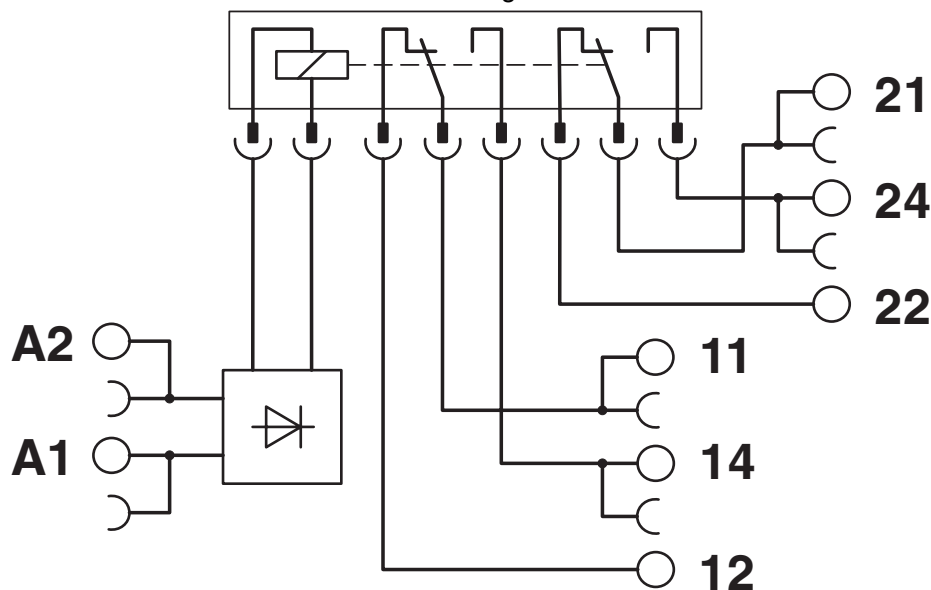

Diagram

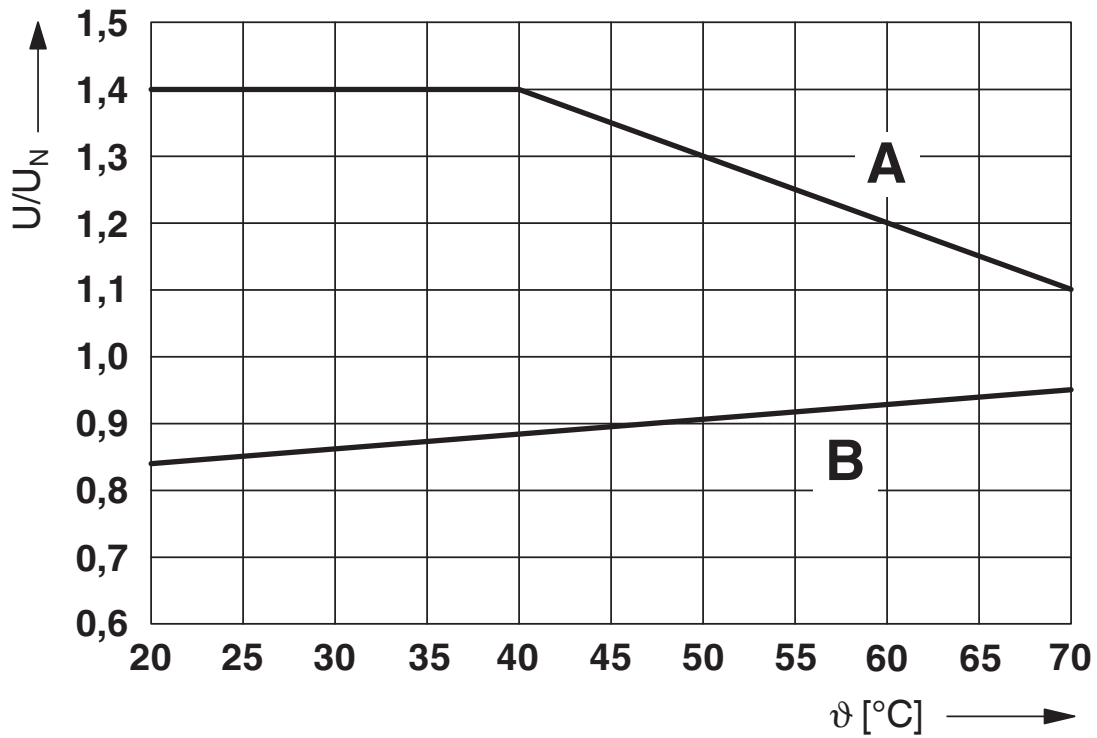

Curve A

Maximum permissible continuous voltage U_{\max} with limiting continuous current on the contact side (see relevant technical data)

Curve B

Minimum permissible operate voltage U_{op} after pre-excitation (see relevant technical data)

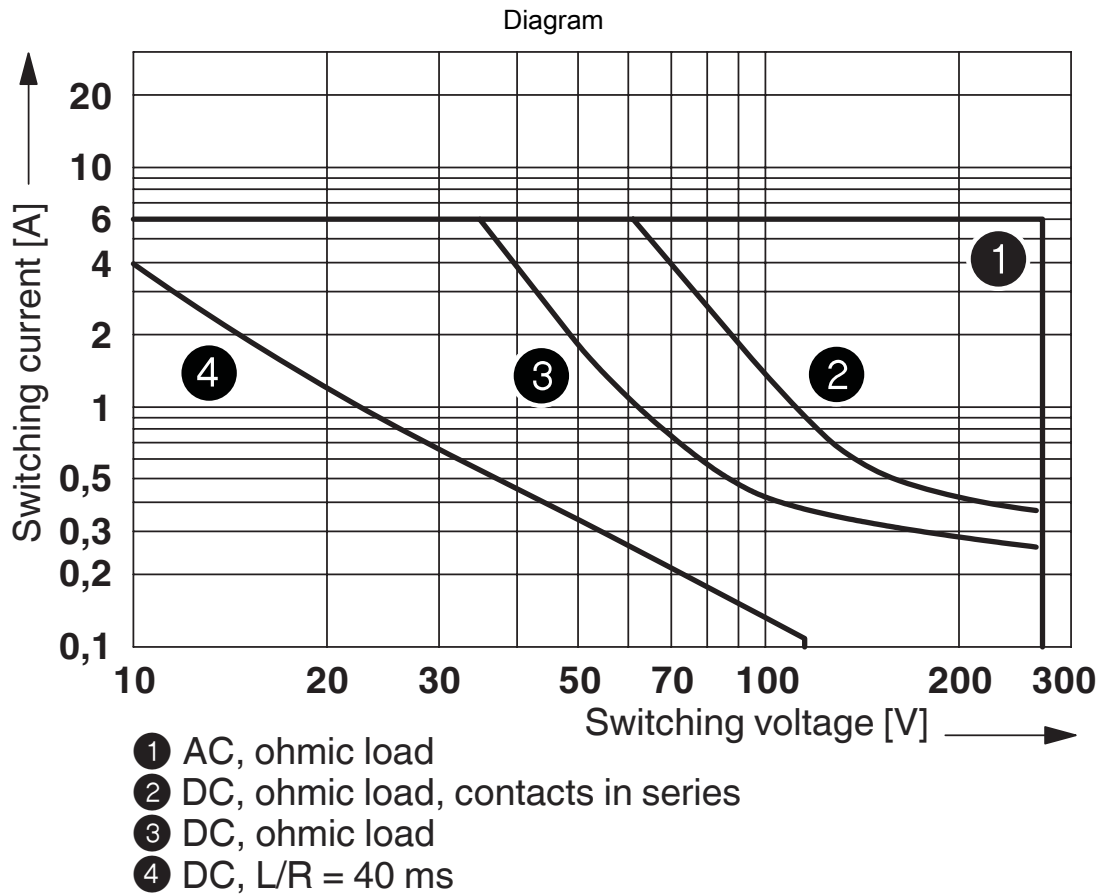

Interrupting rating

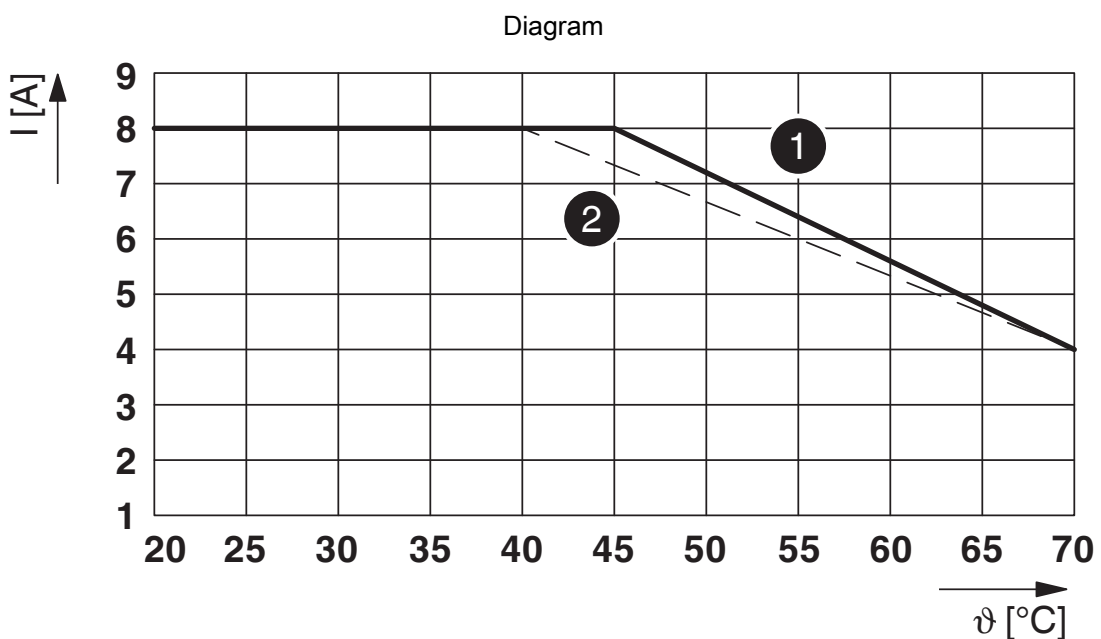

Limiting continuous current per contact for 0.85 ... 1.1 U_N (contact-side)

- (1) Limiting continuous current for horizontal installation position without clearance
- (2) Limiting continuous current for vertical installation position without clearance

PLC-RSC- 24DC/21-21 - Relay Module



2967060

<https://www.phoenixcontact.com/gb/products/2967060>

Approvals

To download certificates, visit the product detail page: <https://www.phoenixcontact.com/gb/products/2967060>



cUL Recognized
Approval ID: FILE E 238705



UL Recognized
Approval ID: FILE E 238705



EAC
Approval ID: TR_TS_D_00573_c



DNV GL
Approval ID: TAE0000196



EAC
Approval ID: RU*C-DE.*08.B.00010



UL Listed
Approval ID: FILE E 172140



cUL Listed
Approval ID: FILE E 172140



cULus Listed
Approval ID: E140324



cULus Listed
Approval ID: E199827

cULus Recognized

cULus Listed

PLC-RSC- 24DC/21-21 - Relay Module



2967060

<https://www.phoenixcontact.com/gb/products/2967060>

Classifications

ECLASS

| | |
|-------------|----------|
| ECLASS-11.0 | 27371601 |
| ECLASS-12.0 | 27371601 |
| ECLASS-13.0 | 27371601 |

ETIM

| | |
|----------|----------|
| ETIM 9.0 | EC001437 |
|----------|----------|

UNSPSC

| | |
|-------------|----------|
| UNSPSC 21.0 | 39122300 |
|-------------|----------|

PLC-RSC- 24DC/21-21 - Relay Module



2967060

<https://www.phoenixcontact.com/gb/products/2967060>

Environmental product compliance

| | |
|------------|--|
| REACH SVHC | Lead 7439-92-1 |
| | Hexahydromethylphthalic anhydride |
| China RoHS | Environmentally Friendly Use Period = 50 years |
| | For information on hazardous substances, refer to the manufacturer's declaration available under "Downloads" |

PLC-RSC- 24DC/21-21 - Relay Module

2967060

<https://www.phoenixcontact.com/gb/products/2967060>

Accessories

 Note: Applying some accessories below might limit this product.

FBST 500-PLC RD - Continuous plug-in bridge

2966786

<https://www.phoenixcontact.com/gb/products/2966786>



Continuous plug-in bridge, length: 500 mm, color: red

 Max. current carrying capacity: 32 A

FBST 500-PLC BU - Continuous plug-in bridge

2966692

<https://www.phoenixcontact.com/gb/products/2966692>

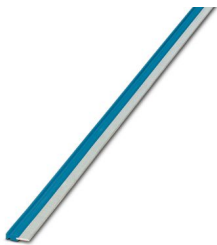

Continuous plug-in bridge, length: 500 mm, color: blue

 Max. current carrying capacity: 32 A

PLC-RSC- 24DC/21-21 - Relay Module

2967060

<https://www.phoenixcontact.com/gb/products/2967060>



FBST 500-PLC GY - Continuous plug-in bridge

2966838

<https://www.phoenixcontact.com/gb/products/2966838>



Continuous plug-in bridge, length: 500 mm, color: gray

 Max. current carrying capacity: 32 A

FBST 6-PLC RD - Single plug-in bridge

2966236

<https://www.phoenixcontact.com/gb/products/2966236>

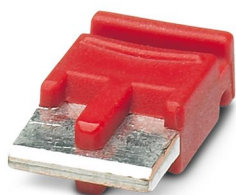

Single plug-in bridge, number of positions: 2, length: 6 mm, color: red

 Max. current carrying capacity: 6 A

PLC-RSC- 24DC/21-21 - Relay Module

2967060

<https://www.phoenixcontact.com/gb/products/2967060>



FBST 6-PLC BU - Single plug-in bridge

2966812

<https://www.phoenixcontact.com/gb/products/2966812>

Single plug-in bridge, number of positions: 2, length: 6 mm, color: blue



 Max. current carrying capacity: 6 A

FBST 6-PLC GY - Single plug-in bridge

2966825

<https://www.phoenixcontact.com/gb/products/2966825>

Single plug-in bridge, number of positions: 2, length: 6 mm, color: gray

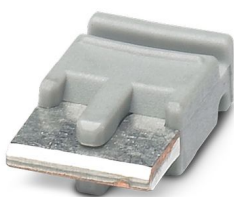

 Max. current carrying capacity: 6 A

PLC-RSC- 24DC/21-21 - Relay Module



2967060

<https://www.phoenixcontact.com/gb/products/2967060>

PLC-V8L/FLK14/OUT - System connection

2299660

<https://www.phoenixcontact.com/gb/products/2299660>



V8 adapter for 8 x PLC-INTERFACE (14 mm), controller: PLC system cabling of output cards, connection 1: IDC/FLK pin strip 1x 14-position, connection 2: Plug-in connection (Can be snapped onto 8x PLC-INTERFACE terminals), connection 3: Screw connection 1x 2-position, number of channels: 8, control logic: plusschaltend

PLC-V8L/FLK14/OUT/M - System connection

2304306

<https://www.phoenixcontact.com/gb/products/2304306>



V8 adapter for 8 x PLC-INTERFACE (14 mm), controller: PLC system cabling of output cards, connection 1: IDC/FLK pin strip 1x 14-position, connection 2: Plug-in connection (Can be snapped onto 8x PLC-INTERFACE terminals), connection 3: Screw connection 1x 2-position, number of channels: 8, control logic: minusschaltend

PLC-RSC- 24DC/21-21 - Relay Module

2967060

<https://www.phoenixcontact.com/gb/products/2967060>

ZB 10:UNBEDRUCKT - Zack marker strip

1053001

<https://www.phoenixcontact.com/gb/products/1053001>



Zack marker strip, Strip, white, unlabeled, can be labeled with: PLOTMARK, CMS-P1-PLOTTER, mounting type: snapped, for terminal block width: 10.2 mm, lettering field size: 10.5 x 10.15 mm, Number of individual labels: 10

ZB 10 CUS - Zack marker strip

0824941

<https://www.phoenixcontact.com/gb/products/0824941>



Zack marker strip, can be ordered: Strip, white, labeled according to customer specifications, mounting type: snap into tall marker groove, for terminal block width: 10.2 mm, lettering field size: 10,15 x 10,5 mm, Number of individual labels: 10

PLC-RSC- 24DC/21-21 - Relay Module



2967060

<https://www.phoenixcontact.com/gb/products/2967060>

ZB10,LGS:FORTL.ZAHLEN - Zack marker strip

1053014

<https://www.phoenixcontact.com/gb/products/1053014>



Zack marker strip, Strip, white, labeled, can be labeled with: CMS-P1-PLOTTER, printed horizontally: consecutive numbers 1 ... 10, 11 ... 20, etc. up to 91 ... 100, mounting type: snapped, for terminal block width: 10.2 mm, lettering field size: 10,15 x 10,5 mm, Number of individual labels: 10

ZB10,QR:FORTL.ZAHLEN - Zack marker strip

1053027

<https://www.phoenixcontact.com/gb/products/1053027>



Zack marker strip, Strip, white, labeled, can be labeled with: CMS-P1-PLOTTER, Printed vertically: consecutive numbers 1 ... 10, 11 ... 20, etc. up to 91 ... 100, mounting type: snapped, for terminal block width: 10.2 mm, lettering field size: 10,15 x 10,5 mm, Number of individual labels: 10

PLC-RSC- 24DC/21-21 - Relay Module

2967060

<https://www.phoenixcontact.com/gb/products/2967060>

ZB10,LGS:L1-N,PE - Marker for terminal blocks

1053412

<https://www.phoenixcontact.com/gb/products/1053412>

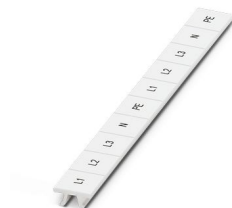

Marker for terminal blocks, Strip, white, labeled, can be labeled with: CMS-P1-PLOTTER, horizontal: L1, L2, L3, N, PE, L1, L2, L3, N, PE, mounting type: snapped, for terminal block width: 10.2 mm, lettering field size: 10,15 x 10,5 mm, Number of individual labels: 10

ZB10,LGS:U-N - Marker for terminal blocks

1053438

<https://www.phoenixcontact.com/gb/products/1053438>



Marker for terminal blocks, Strip, white, labeled, can be labeled with: CMS-P1-PLOTTER, horizontal: U, V, W, N, GND, U, V, W, N, GND, mounting type: snapped, for terminal block width: 10.2 mm, lettering field size: 10,15 x 10,5 mm, Number of individual labels: 10

PLC-RSC- 24DC/21-21 - Relay Module



2967060

<https://www.phoenixcontact.com/gb/products/2967060>

UC-TM 10 - Marker for terminal blocks

0818069

<https://www.phoenixcontact.com/gb/products/0818069>



Marker for terminal blocks, Sheet, white, unlabeled, can be labeled with: BLUEMARK ID COLOR, BLUEMARK ID, BLUEMARK CLED, PLOTMARK, CMS-P1-PLOTTER, mounting type: snapped, for terminal block width: 10.2 mm, lettering field size: 9.6 x 10.5 mm, Number of individual labels: 48

UC-TM 10 CUS - Marker for terminal blocks

0824605

<https://www.phoenixcontact.com/gb/products/0824605>



Marker for terminal blocks, can be ordered: by sheet, white, labeled according to customer specifications, mounting type: snap into tall marker groove, for terminal block width: 10.2 mm, lettering field size: 9.6 x 10.5 mm, Number of individual labels: 48

PLC-RSC- 24DC/21-21 - Relay Module



2967060

<https://www.phoenixcontact.com/gb/products/2967060>

UCT-TM 10 - Marker for terminal blocks

0829142

<https://www.phoenixcontact.com/gb/products/0829142>



Marker for terminal blocks, Sheet, white, unlabeled, can be labeled with: TOPMARK NEO, TOPMARK LASER, BLUEMARK ID COLOR, BLUEMARK ID, BLUEMARK CLED, THERMOMARK PRIME, THERMOMARK CARD 2.0, THERMOMARK CARD, mounting type: snapped, for terminal block width: 10.2 mm, lettering field size: 8.9 x 9.6 mm, Number of individual labels: 36

UCT-TM 10 CUS - Marker for terminal blocks

0829623

<https://www.phoenixcontact.com/gb/products/0829623>



Marker for terminal blocks, can be ordered: by sheet, white, labeled according to customer specifications, mounting type: snap into tall marker groove, for terminal block width: 10.2 mm, lettering field size: 8.9 x 9.6 mm, Number of individual labels: 36

PLC-RSC- 24DC/21-21 - Relay Module



2967060

<https://www.phoenixcontact.com/gb/products/2967060>

ZB 12:UNPRINTED - Zack marker strip

0812120

<https://www.phoenixcontact.com/gb/products/0812120>

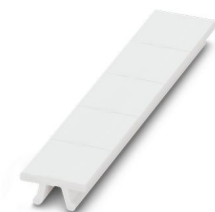

Zack marker strip, Strip, white, unlabeled, can be labeled with: PLOTMARK, CMS-P1-PLOTTER, mounting type: snapped, for terminal block width: 12.2 mm, lettering field size: 12 x 10.5 mm, Number of individual labels: 5

ZB 12 CUS - Zack marker strip

0824942

<https://www.phoenixcontact.com/gb/products/0824942>

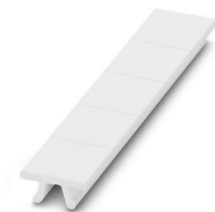

Zack marker strip, can be ordered: Strip, white, labeled according to customer specifications, mounting type: snap into tall marker groove, for terminal block width: 12.2 mm, lettering field size: 10.5 x 12.15 mm, Number of individual labels: 5

PLC-RSC- 24DC/21-21 - Relay Module



2967060

<https://www.phoenixcontact.com/gb/products/2967060>

ZB 12,LGS:L1-N,PE - Zack marker strip

0812146

<https://www.phoenixcontact.com/gb/products/0812146>

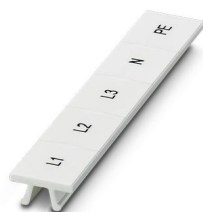

Zack marker strip, Strip, white, labeled, printed horizontally: L1, L2, L3, N, PE, mounting type: snapped, for terminal block width: 12.2 mm, lettering field size: 10.5 x 12.15 mm, Number of individual labels: 5

UC-TM 12 - Marker for terminal blocks

0819194

<https://www.phoenixcontact.com/gb/products/0819194>



Marker for terminal blocks, Sheet, white, unlabeled, can be labeled with: BLUEMARK ID COLOR, BLUEMARK ID, BLUEMARK CLED, PLOTMARK, CMS-P1-PLOTTER, mounting type: snapped, for terminal block width: 12 mm, lettering field size: 11.45 x 10.5 mm, Number of individual labels: 40

PLC-RSC- 24DC/21-21 - Relay Module



2967060

<https://www.phoenixcontact.com/gb/products/2967060>

UC-TM 12 CUS - Marker for terminal blocks

0824613

<https://www.phoenixcontact.com/gb/products/0824613>



Marker for terminal blocks, can be ordered: by sheet, white, labeled according to customer specifications, mounting type: snap into tall marker groove, for terminal block width: 12 mm, lettering field size: 11.45 x 10.5 mm, Number of individual labels: 40

UCT-TM 12 - Marker for terminal blocks

0829144

<https://www.phoenixcontact.com/gb/products/0829144>



Marker for terminal blocks, Sheet, white, unlabeled, can be labeled with: TOPMARK NEO, TOPMARK LASER, BLUEMARK ID COLOR, BLUEMARK ID, BLUEMARK CLED, THERMOMARK PRIME, THERMOMARK CARD 2.0, THERMOMARK CARD, mounting type: snapped, for terminal block width: 12 mm, lettering field size: 10.8 x 9.6 mm, Number of individual labels: 30

PLC-RSC- 24DC/21-21 - Relay Module

2967060

<https://www.phoenixcontact.com/gb/products/2967060>



UCT-TM 12 CUS - Marker for terminal blocks

0829630

<https://www.phoenixcontact.com/gb/products/0829630>



Marker for terminal blocks, can be ordered: by sheet, white, labeled according to customer specifications, mounting type: snap into tall marker groove, for terminal block width: 12 mm, lettering field size: 10.8 x 9.6 mm, Number of individual labels: 30

NS 35/ 7,5 PERF 2000MM - DIN rail perforated

0801733

<https://www.phoenixcontact.com/gb/products/0801733>



DIN rail perforated, Pack of 25 (50 m), acc. to EN 60715, material: Steel, galvanized, passivated with a thick layer, Standard profile, color: silver

PLC-RSC- 24DC/21-21 - Relay Module

2967060

<https://www.phoenixcontact.com/gb/products/2967060>



NS 35/ 7,5 UNPERF 2000MM - DIN rail, unperforated

0801681

<https://www.phoenixcontact.com/gb/products/0801681>



DIN rail, unperforated, Pack of 25 (50 m), acc. to EN 60715, material: Steel, galvanized, passivated with a thick layer, Standard profile, color: silver

NS 35/ 7,5 WH PERF 2000MM - DIN rail perforated

1204119

<https://www.phoenixcontact.com/gb/products/1204119>



DIN rail perforated, Pack of 25 (50 m), acc. to EN 60715, material: Steel, Galvanized, white passivated, Standard profile, color: silver

PLC-RSC- 24DC/21-21 - Relay Module

2967060

<https://www.phoenixcontact.com/gb/products/2967060>



NS 35/ 7,5 WH UNPERF 2000MM-VPE 10 - DIN rail, unperforated

1204122

<https://www.phoenixcontact.com/gb/products/1204122>



DIN rail, unperforated, Pack of 10 (20 m), acc. to EN 60715, material: Steel, Galvanized, white passivated, Standard profile, color: silver

NS 35/ 7,5 AL UNPERF 2000MM - DIN rail, unperforated

0801704

<https://www.phoenixcontact.com/gb/products/0801704>



DIN rail, unperforated, Pack of 25 (50 m), acc. to EN 60715, material: Aluminum, uncoated, Standard profile, color: silver

PLC-RSC- 24DC/21-21 - Relay Module

2967060

<https://www.phoenixcontact.com/gb/products/2967060>

NS 35/ 7,5 ZN PERF 2000MM - DIN rail perforated

1206421

<https://www.phoenixcontact.com/gb/products/1206421>



DIN rail perforated, Pack of 25 (50 m), acc. to EN 60715, material: Steel, galvanized, Standard profile, color: silver

NS 35/ 7,5 ZN UNPERF 2000MM - DIN rail, unperforated

1206434

<https://www.phoenixcontact.com/gb/products/1206434>



DIN rail, unperforated, Pack of 25 (50 m), acc. to EN 60715, material: Steel, galvanized, Standard profile, color: silver

PLC-RSC- 24DC/21-21 - Relay Module



2967060

<https://www.phoenixcontact.com/gb/products/2967060>

NS 35/ 7,5 CU UNPERF 2000MM-VPE 10 - DIN rail, unperforated

0801762

<https://www.phoenixcontact.com/gb/products/0801762>



DIN rail, unperforated, Pack of 10 (20 m), acc. to EN 60715, material: Copper, uncoated, Standard profile, color: copper-colored

NS 35/ 7,5 CAP - End cap

1206560

<https://www.phoenixcontact.com/gb/products/1206560>

DIN rail end piece, for DIN rail NS 35/7.5



PLC-RSC- 24DC/21-21 - Relay Module

2967060

<https://www.phoenixcontact.com/gb/products/2967060>

NS 35/15 PERF 2000MM - DIN rail perforated

1201730

<https://www.phoenixcontact.com/gb/products/1201730>



DIN rail perforated, Pack of 25 (50 m), similar to EN 60715, material: Steel, galvanized, passivated with a thick layer, Standard profile, color: silver

NS 35/15 UNPERF 2000MM - DIN rail, unperforated

1201714

<https://www.phoenixcontact.com/gb/products/1201714>

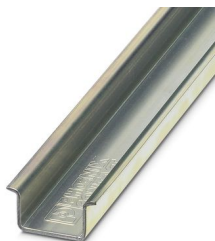

DIN rail, unperforated, Pack of 25 (50 m), similar to EN 60715, material: Steel, galvanized, passivated with a thick layer, Standard profile, color: silver

PLC-RSC- 24DC/21-21 - Relay Module

2967060

<https://www.phoenixcontact.com/gb/products/2967060>

NS 35/15 WH PERF 2000MM - DIN rail perforated

0806602

<https://www.phoenixcontact.com/gb/products/0806602>



DIN rail perforated, Pack of 25 (50 m), similar to EN 60715, material: Steel, Galvanized, white passivated, Standard profile, color: white

NS 35/15 WH UNPERF 2000MM-VPE 10 - DIN rail, unperforated

1204135

<https://www.phoenixcontact.com/gb/products/1204135>



DIN rail, unperforated, Pack of 10 (20 m), similar to EN 60715, material: Steel, Galvanized, white passivated, Standard profile, color: silver

PLC-RSC- 24DC/21-21 - Relay Module



2967060

<https://www.phoenixcontact.com/gb/products/2967060>

NS 35/15 AL UNPERF 2000MM - DIN rail, unperforated

1201756

<https://www.phoenixcontact.com/gb/products/1201756>



DIN rail, unperforated, similar to EN 60715, material: Aluminum, uncoated, Standard profile, color: silver

NS 35/15 ZN PERF 2000MM - DIN rail perforated

1206599

<https://www.phoenixcontact.com/gb/products/1206599>



DIN rail perforated, Pack of 25 (50 m), similar to EN 60715, material: Steel, galvanized, Standard profile, color: silver

PLC-RSC- 24DC/21-21 - Relay Module

2967060

<https://www.phoenixcontact.com/gb/products/2967060>



NS 35/15 ZN UNPERF 2000MM - DIN rail, unperforated

1206586

<https://www.phoenixcontact.com/gb/products/1206586>



DIN rail, unperforated, Pack of 25 (50 m), similar to EN 60715, material: Steel, galvanized, Standard profile, color: silver

NS 35/15 CU UNPERF 2000MM-VPE 10 - DIN rail, unperforated

1201895

<https://www.phoenixcontact.com/gb/products/1201895>



DIN rail, unperforated, Pack of 10 (20 m), similar to EN 60715, material: Copper, uncoated, Standard profile, color: copper-colored

PLC-RSC- 24DC/21-21 - Relay Module

2967060

<https://www.phoenixcontact.com/gb/products/2967060>



NS 35/15 CAP - End cap

1206573

<https://www.phoenixcontact.com/gb/products/1206573>

DIN rail end piece, for DIN rail NS 35/15



NS 35/15-2,3 UNPERF 2000MM-VPE 10 - DIN rail, unperforated

1201798

<https://www.phoenixcontact.com/gb/products/1201798>

DIN rail, unperforated, Pack of 10 (20 m), acc. to EN 60715, material: Steel, galvanized, passivated with a thick layer, Standard profile 2.3 mm, color: silver



PLC-RSC- 24DC/21-21 - Relay Module

2967060

<https://www.phoenixcontact.com/gb/products/2967060>



PLC-ATP BK - Separating plate

2966841

<https://www.phoenixcontact.com/gb/products/2966841>



Separating plate, 2 mm thick, required at the start and end of a PLC terminal strip. Furthermore, it is used for: visual separation of groups, safe isolation of different voltages of neighboring PLC relays in acc. with DIN VDE 0106-101, isolation

PLC-ESK GY - Power terminal block

2966508

<https://www.phoenixcontact.com/gb/products/2966508>



Power terminal block, for the input of up to four potentials, for mounting on NS 35/7.5

PLC-RSC- 24DC/21-21 - Relay Module

2967060

<https://www.phoenixcontact.com/gb/products/2967060>



SZF 1-0,6X3,5 - Screwdriver

1204517

<https://www.phoenixcontact.com/gb/products/1204517>



Actuation tool, for ST terminal blocks, also suitable for use as a bladed screwdriver, size: 0.6 x 3.5 x 100 mm, 2-component grip, with non-slip grip

REL-MR- 24DC/21-21 - Single relay

2961192

<https://www.phoenixcontact.com/gb/products/2961192>

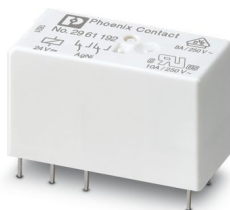

Plug-in miniature power relay, with power contact, 2 changeover contacts, input voltage 24 V DC

Phoenix Contact 2023 © - all rights reserved
<https://www.phoenixcontact.com>

PHOENIX CONTACT Ltd
Halesfield 13, Telford
Shropshire, TF7 4PG
01952 681700
info@phoenixcontact.co.uk