

12320200150

D985 |5| ZPL HX LCKNT/INS MF M20X1,50

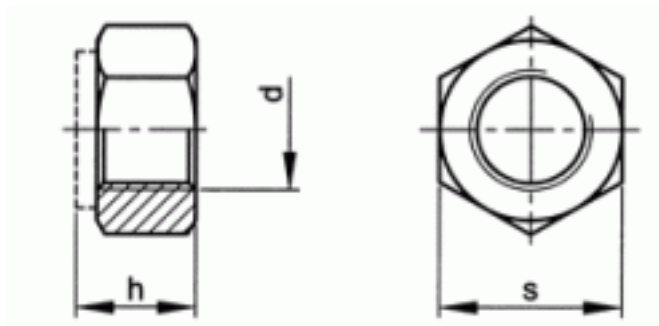

Brand	-
UBB Code	950355120292
UNSPSC Code	31161727
EAN Code	8715492577429
Head shape	hexagon head
Thread	Metric fine thread
Class	≥ 5
Material	Steel
Surface treatment	Zinc plated
Driving features	hexagon



s	30
h	15
P	1,50
d	M20
Packaging (Piece )	25.0



Copyright Fabory Group