

12300040001

D985 |5| ZPL HX LCKNT/INS SP M4

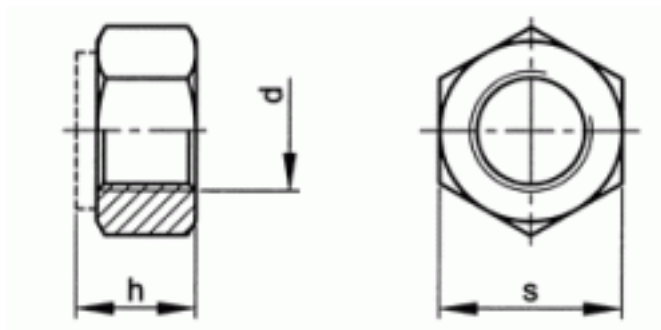

Brand	-
UBB Code	950355115672
UNSPSC Code	31161727
EAN Code	8715492576811
Driving features	hexagon
Thread	Metric thread
Class	≥ 5
Material	Steel
Surface treatment	Zinc plated



s	7
h	5
P	0,7
d	M4
Packaging (Piece)	250.0



Copyright Fabory Group