

CATALOG

# Softstarter

Type PSR, PSE and PSTX



—

**Motors use almost one third of the world's generated electricity. So it is safe to say that reliable motor operation is crucial to our modern way of life.**

---

# Contents

<b>04–13</b>	<b>ABB softstarter</b>
<b>14–23</b>	<b>PSR - The compact range</b>
<b>24–37</b>	<b>PSE - The efficient range</b>
<b>38–57</b>	<b>PSTX - The advanced range</b>
<b>58–65</b>	<b>Fieldbus communication</b>
<b>66–67</b>	<b>Marketing materials and tools</b>

---

# ABB softstarter

## How we are helping the industry

A softstarter from ABB offers you several values and benefits. Whether you are a consultant, OEM, panel builder or end-user, a softstarter will add to your business value by securing motor reliability, improving installation efficiency and increasing application productivity.

### SECURE MOTOR

## Reliability



ABB softstarters help increase your motor's lifetime by protecting it from electrical stress. Starting currents are easily optimized to your load, application and motor size. Over ten motor protection features are included to keep your motor safe from different load and network irregularities.

### IMPROVE INSTALLATION

## Efficiency

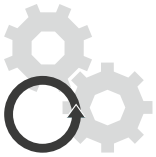

Reduce your installation time and panel size by having all features you need built into your softstarter. Our softstarters are easy to install thanks to their compact design and many built-in features. The built-in bypass saves energy and space while reducing heat generation. A complete motor starting solution in one unit.

### INCREASE APPLICATION

## Productivity



Reduce the number of stops in your production by allowing your softstarter to do more than just starting. Our softstarters reduce the mechanical stress on your motor application, which will increase your uptime. Torque control, pump cleaning, motor brake and many other features enable you to operate your process at its full potential.

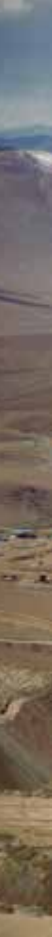



## Xylem - South Africa

ABB's softstarters providing efficiency to the mining industry

One of Xylem's water solutions helps to prevent flooding in mines. Previous softstarters needed a lot of extra protection equipment. Xylem was looking for a simpler solution that would ensure reliability even at 3,500 meters depth. Reducing the number of components by 80 percent, shortened installation time by 60 percent. Costs cut to half has helped Xylem sell twice as many panels with softstarters as before.

Why softstarting matters to Xylem

Installation time reduced by

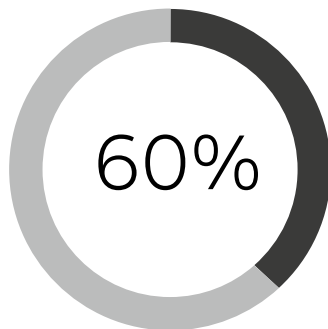

Total panel cost reduced by

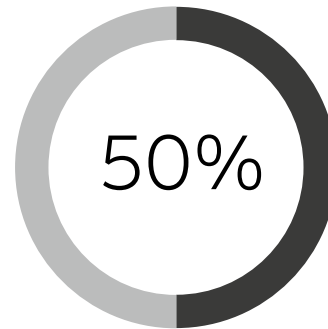

For more examples of how ABB's softstarters are helping the industry, visit [www.abb.com/lowvoltage/launches/pstx](http://www.abb.com/lowvoltage/launches/pstx)

# ABB softstarter

## How we are helping the industry

A softstarter can do wonders with your operations. Packed with useful features, it reduces the wear of your equipment, improve the reliability of your processes and increase overall productivity.

### Controlling pumps

#### ELIMINATING WATER HAMMERING WITH TORQUE CONTROL

Water hammering is a common problem with pumps. It typically results in a lot on wear of pipes and valves when stopping the pump. The ABB softstarter feature torque control stop eliminates water hammering and prolongs the lifetime of the system, while reducing pump downtime.

#### KEEP PIPES AND PUMPS CLEAN

Many pumps risk getting clogged over time. This will cause reduced flow and increased risk of pump damage. Thanks to the feature to reverse the direction of the flow and start again with kick-start, ABB softstarters can help prevent and solve pump clogging and associated downtime.

#### AVOID RUNNING DRY WITH UNDERLOAD PROTECTION

Damages due to pumps running dry can be avoided with the softstarter feature underload protection. It stops the motor which saves the pump from additional wear and contributes to prolonging its lifetime.



### Controlling fans

#### SOFT STARTING ADJUSTED TO APPLICATION

Fans normally have a high moment of inertia, which makes starting tough and current high. Using an ABB softstarter, the voltage is increased gradually during start, which reduces the current and removes the inrush peak. It is possible to adjust the settings to fit almost any starting condition, from unloaded to fully loaded.

#### FAST STOPS WITH MOTOR BRAKING

It can also take a long time to stop the fan. Active braking using the dynamic brake feature reduces stopping times. This improves process safety when the load has a high moment of inertia and makes fan operation easier for the operator.

#### AVOID UNWANTED MOVEMENTS WITH STAND STILL BRAKE

An idle fan that is rotating backwards, due to wind or airflow from another fan, can be kept still using the stand still brake. It prevents unwanted airflow and improves the control of the system without the need for an external mechanical brake.

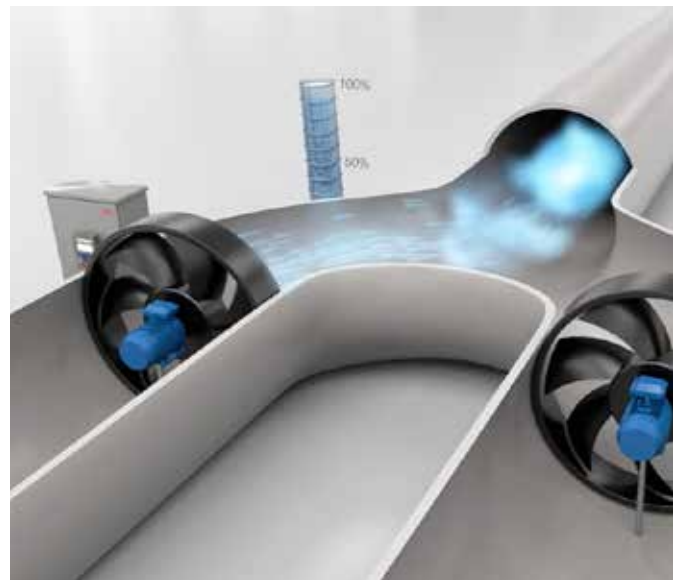

## Controlling conveyor belts

### AVOID OVERHEATING WITH OVERLOAD PROTECTION

Too much material on a conveyor belt may cause overload and overheating, reducing the reliability and longevity of the motor. ABB's overload protection feature shuts down the motor in case of overload, avoiding overheating.

### INCREASED FLEXIBILITY WITH JOG WITH SLOW SPEED

After stopping the belt, it may be necessary to run the motor at low speed to correctly position the belt before resuming operation. The jog with slow speed feature makes it possible to position the belt manually, in both forward and reverse direction, before re-starting the belt. This improves process efficiency and eliminates the need for a variable speed drive, a considerably more expensive solution for solving the problem.

### CONTINUOUS OPERATION WITH LIMP MODE

Shorted thyristor is a possible problem for a softstarter, putting it out of operation until the component has been replaced. Using limp mode, the softstarter will continue to work with one thyristor shorted, avoiding costly unplanned stoppages.



## Controlling compressors

### FULL CONTROL OF CURRENT WITH CURRENT LIMIT

Many applications are sensitive to high or variable starting currents. The feature current limit makes it possible to start the motor securely even in a weaker network, improving the availability of the equipment and system. Reducing the current means reducing the stress on cables, network and motor.

### FULL VOLTAGE START FOR SCROLL COMPRESSORS

For scroll compressors it is often necessary to start the motor in a very short time while still maintaining a low starting current. Full voltage start is a start mode that gives you almost a direct start but without the current peak.

### PHASE REVERSAL PROTECTION FOR PROBLEM-FREE COMMISSIONING

A motor rotating in the wrong direction, which may occur due to connecting the phases wrongly, may cause severe damage to a compressor. Using phase reversal protection, the motor won't start in the wrong direction, avoiding costly compressor downtime and repairs.



# ABB softstarters

## Why motor starting and stopping matters

There are some common issues associated with starting and stopping electrical motors. Depending on requirement, different starting and stopping methods can be used.



### DIRECT-ON-LINE

Direct-on-line starting (DOL) is the easiest and most commonly used starting method. It is suitable for stable networks and mechanically stiff and well-dimensioned shaft systems due to the high current and torque generated during start.

DOL starting is uncontrolled, which means that the motor will start with maximum current and torque regardless of load type.



### STAR-DELTA

A star-delta starter reduces current and torque during start. The starting current is about one third compared to direct-on-line starting, although it also reduces the starting torque to about 25 percent.

Star-delta is not adjustable, so if the torque is reduced too much, the motor will not start. Current peaks will happen when switching from star to delta connection.



### SOFTSTARTER

Like direct-on-line and star delta starters, softstarters are used to start and stop motors in full-speed applications. It eliminates common problems associated with motor starting and stopping, including electrical surges, spikes and high inrush currents.

Because it offers soft starting and stopping, a softstarter is the optimal compromise between a direct-on-line or star-delta starter and a variable speed drive in many full-speed motor applications.

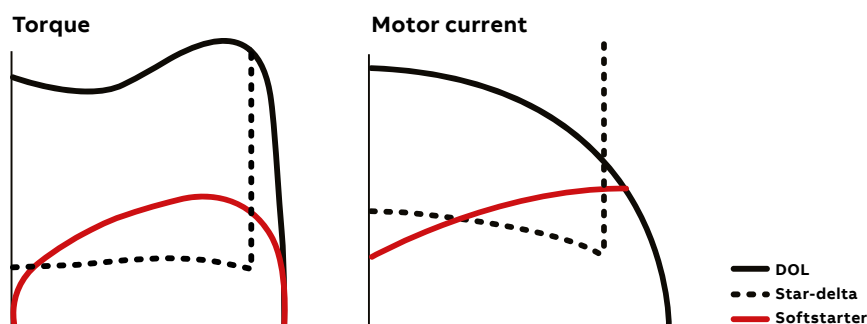

Typical torque and current curves from starting a motor using DOL, star-delta and softstarter.

### VARIABLE SPEED DRIVE

Like a softstarter, a variable speed drive (VSD) can perform soft motor starting and stopping. However, the VSD was designed primarily to control motor speed, resulting in energy efficient motor operation in variable speed applications. Using a VSD with the sole purpose of ensuring soft starting and stopping of full-speed motors can therefore be considered an unnecessarily advanced solution.



---

# ABB softstarters

## A part of your motor starting solution

Motor starting requires several components to work perfectly together. ABB is a one-stop shop for motor starting, offering all the necessary components and complete motor starting solutions, proven together in numerous installations worldwide.



---

### Can I use a Softstarter for an ATEX motor?

ABB's softstarters PSR, PSE and PSTX can be used to start ATEX classified motors in Ex environments if the following considerations are taken into account:

- The softstarter has to be placed outside the Ex area. Either in another location or inside an ATEX approved panel.
- A separate ATEX approved overload relay from ABB has to be used together with a line contactor. This overload relay will replace the built-in EOL in the softstarter and has an ATEX approved tripping curve.
- Select softstarter according to normal or heavy-duty start depending on application and line contactor and overload relay with type 2 coordination.



---

### Can I use a softstarter on a ship?

ABB's softstarters PSE and PSTX have marine approvals and are certified for marine environment.

Ships uses IT-networks which means that there is a floating electrical ground. It is possible to use an ABB softstarter in such a network but it is recommended to not connect the functional ground on the softstarter to the ship to avoid disturbances from the network to effect the electronics inside the softstarter.

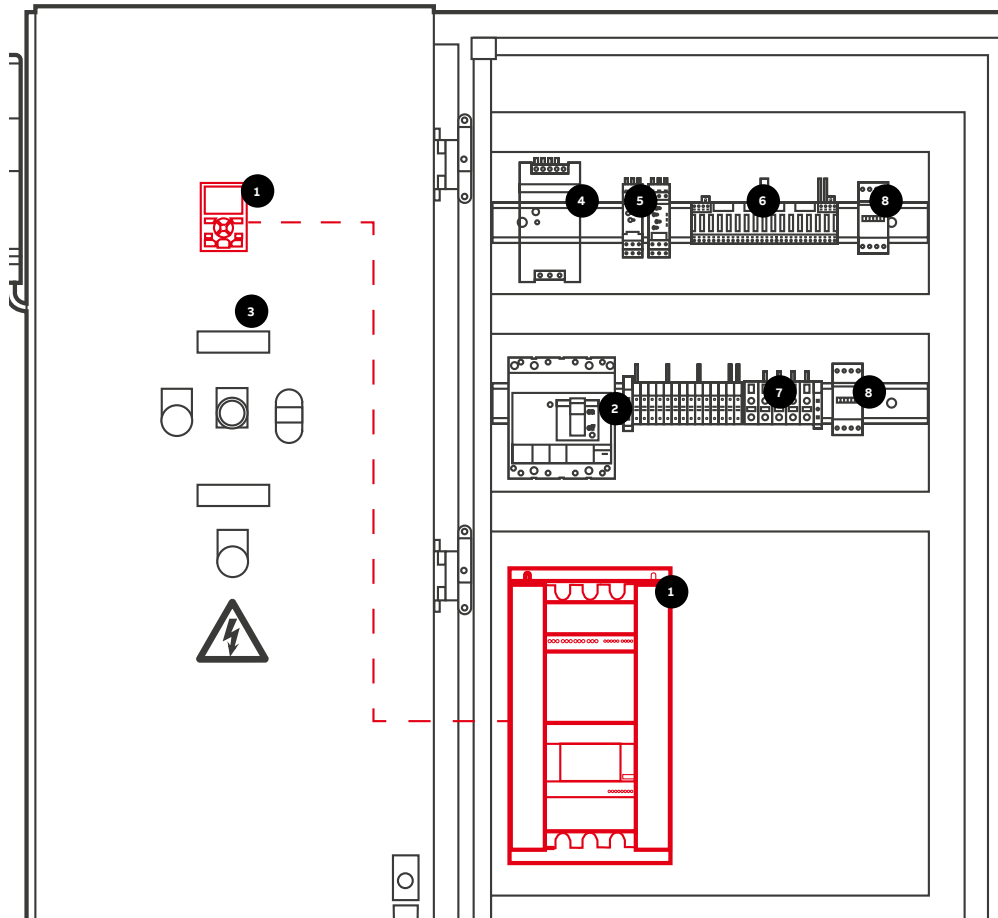

- 1** SOFTSTARTER
- Soft start and stop with reduced current
  - Features to improve process productivity
  - Detachable keypad for front door mounting on a panel



- 2** SHORT CIRCUIT BREAKER MCCB
- Short circuit protection of motor
  - Possibility for electrical isolation



- 3** PILOT DEVICES
- Remote control of motor
  - Indication of softstarter and motor status with light and sound
  - Emergency stop of motor



- 4** POWER SUPPLY CP-E
- Possible to use 24V AC/DC equipments in the panel, e.g. PLC



- 5** LIQUID LEVEL MONITORING RELAYS CM-ENS
- Monitoring and signalling the water level



- 6** PLC 800M
- Automatic control
  - Remote communication



- 7** TERMINAL BLOCKS SNK RANGE
- Easy installation of control wires



- 8** LINE CONTACTOR AF
- Isolation at stop
  - Isolation at faults
  - Emergency stop
  - Back-up DOL starter

# ABB softstarters

## Wall mounting instructions

Minimum distance to wall mm (in)

Softstarter, type	A <sup>1)</sup>	B <sup>1)</sup>	C	D
<b>PSR</b>				
PSR3 ... PSR16	0	0	25 (0.98)	N/A
PSR25 ... PSR30	0	0	25 (0.98)	N/A
PSR37 ... PSR45	0	0	25 (0.98)	N/A
PSR60 ... PSR105	0	0	25 (0.98)	N/A
<b>PSE</b>				
PSE18 ... PSE105	100 (3.94)	10 (0.39)	20 (0.79)	N/A
PSE142 ... PSE170	100 (3.94)	10 (0.39)	20 (0.79)	N/A
PSE210 ... PSE370	100 (3.94)	10 (0.39)	20 (0.79)	N/A
<b>PSTX</b>				
PSTX30 ... PSTX105	100 (3.94)	10 (0.39)	20 (0.79)	35 (1.38)
PSTX142 ... PSTX170	100 (3.94)	10 (0.39)	20 (0.79)	35 (1.38)
PSTX210 ... PSTX370	100 (3.94)	10 (0.39)	20 (0.79)	35 (1.38)
PSTX470 ... PSTX570	150 (5.91)	15 (0.59)	20 (0.79)	35 (1.38)
PSTX720 ... PSTX840	150 (5.91)	15 (0.59)	20 (0.79)	35 (1.38)
PSTX1050 ... PSTX1250	150 (5.91)	15 (0.59)	20 (0.79)	35 (1.38)

<sup>1)</sup>PSR, Only for wall mounted Softstarters

Minimum distance to front

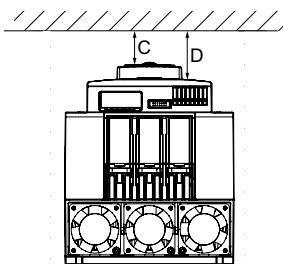

Minimum distance to wall

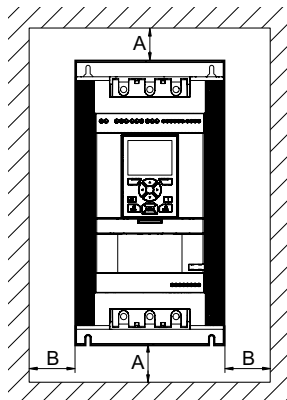

Maximum mounting angle

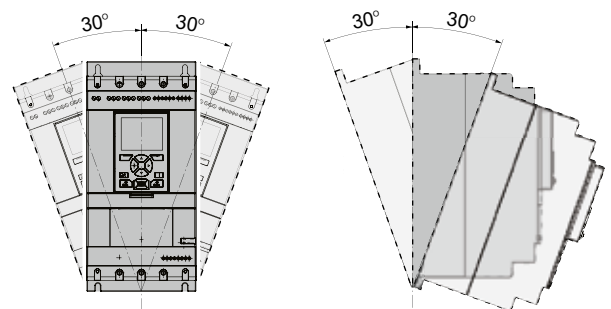

Items included in the box with the softstarter







	Multi-language manual	Terminal kit	Cable and mounting kit for detachable keypad
PSR3 ... PSR105	•	—	—
PSE18 ... PSE370	•	•	—
PSTX30 ... PSTX1250	•	•	•

# ABB softstarters

## Certifications and approvals

The table below shows the certifications and approvals for ABB's softstarters. For other certifications and/or approvals, please contact ABB.

### Certifications and approvals

Abbreviation approved in	Certifications						Approvals: ship classification societies					
							ABS	DNV GL	Lloyd's Register	CCS	PRS	Class NK
PSR3 ... PSR105	•	•	•	•	•	•	—	—	—	—	•	—
PSE18 ... PSE370	•	•	•	•	•	•	•	•	•	•	•	•
PSTX30 ... PSTX1250	•	•	•	•	•	•	•	•	•	•	•	•

Note: • Standard design approved, the products bear the certification mark when it is required.

### Directives and standards

No. 2006/95/EC	Low voltage equipment
No. 2004/108/EC	Electromagnetic compability
EN 60947-1	Low-voltageswitchgear and controlgear - Part 1: General rules
EN 60947-4-2	AC semiconductor motor controllers and starters
UL 508	Industrial Control Equipment
CSA C22.2 No 14	Industrial Control Equipment



The PSR softstarter is the most compact of all the softstarter ranges which allows for design of a compact starting equipment. The PSR combined with a manual motor starter makes up a far more compact starting solution than the complex star-delta starter, and with the built-in bypass, the energy losses inside the softstarter are highly reduced.

---

# PSR - The compact range

<b>16–17</b>	<b>PSR - The compact range</b>
<b>18</b>	<b>Overview</b>
<b>19</b>	<b>Ordering details</b>
<b>20</b>	<b>Accessories</b>
<b>21</b>	<b>Technical data</b>
<b>22</b>	<b>Dimensions</b>
<b>23</b>	<b>Circuit diagrams</b>

# PSR - The compact range

## Introduction



- Two-phase controlled
- Operational voltage: 208...600 V AC
- Wide rated control supply voltage: 100...240 V AC, 50/60 Hz or 24 V AC/DC
- Rated operational current: 3...105 A
- Soft start with voltage ramp
- Soft stop with voltage ramp
- Built-in bypass for energy saving and easy installation
- Easy set-up by three potentiometers
- Fieldbus communication with FieldBusPlugadapter and the FieldBusPlug
- Run and Top of Ramp relays available for monitoring
- Connection kits available for connection to ABB's manual motor starters (MMS)

### SECURE MOTOR

## Reliability

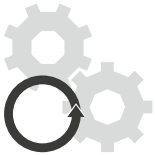

REDUCE THE ELECTRICAL STRESSES AND KEEP THE MOTOR PROTECTED WITH THE MMS

The PSR reduces the starting current for the motor. The possibility to connect it to the manual motor starter makes it possible to build a compact and complete starting solution with overload and short-circuit protection.

### IMPROVE INSTALLATION

## Efficiency



SAVING TIME AND MONEY WITH BUILT-IN BYPASS AND EASY SET-UP

On the PSR, the bypass is built in and verified by ABB, saving you time during installation and space in your panel. Set-up is done through three potentiometers making it very fast and easy.

### INCREASE APPLICATION

## Productivity



REDUCE THE MECHANICAL STRESSES ON YOUR MOTOR

Soft start and stop with PSR will reduce mechanical wear and tear on the application and increase the availability and uptime.

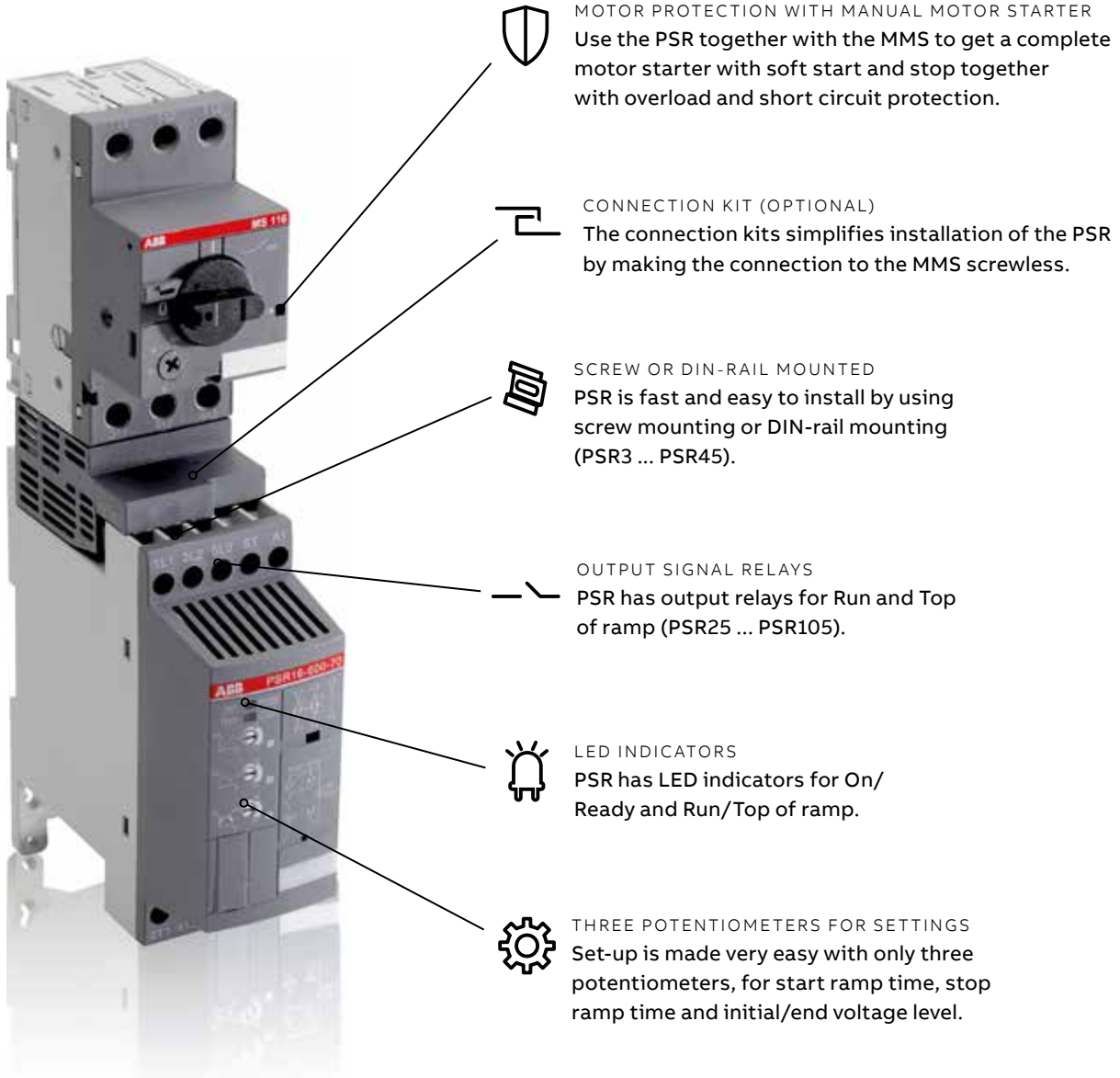

SETTINGS

- 1 Start = 1...20 sec
  - 2 Stop = 0...20 sec - including the step down voltage
  - 3 Step down = 2% reduction for each second increased stop ramp
- $U_{ini} = 40...70\%$  results in end voltage = 30...60%

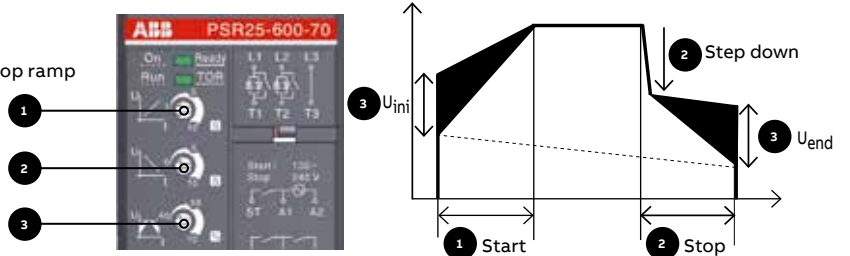

## PSR - The compact range

### Overview



PSR3 ... PSR16



PSR25 ... PSR30



PSR37 ... PSR45



PSR60 ... PSR105

Normal start In-line connected (400 V) kW IEC, max. A (440-480 V) hp UL, max. FLA	PSR3	PSR6	PSR9	PSR12	PSR16	PSR25	PSR30	PSR37	PSR45	PSR60	PSR72	PSR85	PSR105
	1.5	3	4	5.5	7.5	11	15	18.5	22	30	37	45	55
	3.9	6.8	9	12	16	25	30	37	45	60	72	85	105
	2	3	5	7.5	10	15	20	25	30	40	50	60	75
	3.4	6.1	9	11	15.2	24.2	28	34	46.2	59.4	68	80	104

400 V, 40 °C

Using manual motor starters type 1 coordination will be achieved <sup>1)</sup>

Manual motor starter (50 kA)

MS116	MS132	MS450	MS495	—
-------	-------	-------	-------	---

Using gG fuses type 1 coordination will be achieved <sup>1)</sup>

Fuse protection (50 kA) gG Fuse

10 A	16 A	25 A	32 A	50 A	63 A	100 A	125 A	200 A	250 A
------	------	------	------	------	------	-------	-------	-------	-------

Suitable switch fuse for the above gG fuses <sup>1)</sup>

Switch fuse

OS32G	OS125G	OS250
-------	--------	-------

J-type fuses for UL coordination <sup>1)</sup>

Max. fuse, J-type

35 A	60 A	90 A	110 A	125 A	150 A	200 A
------	------	------	-------	-------	-------	-------

Overload protection is used to protect the motor from over heating <sup>1)</sup>

Thermal overload relay

TF42DU	TA75DU	TA110DU
--------	--------	---------

The line contactor is not required for the softstarter itself but often used to open if OL trips <sup>1)</sup>

Line contactor

AF9	AF12	AF16	AF26	AF30	AF38	AF52	AF65	AF80	AF96	AF116
-----	------	------	------	------	------	------	------	------	------	-------

<sup>1)</sup> This is an example of coordination. For more examples see: [applications.it.abb.com/SOC](http://applications.it.abb.com/SOC)

## PSR - The compact range

### Ordering details



#### Typical applications

- Bow thruster
- Centrifugal pump
- Compressor
- Conveyor belt (short)
- Elevator



For a more precise selection, use the online softstarter selection tool available by scanning the shown QR code or using the selection tool available on: [new.abb.com/low-voltage/products/softstarters](http://new.abb.com/low-voltage/products/softstarters)



PSR3 ... PSR16



PSR25 ... PSR30



PSR37 ... PSR45



PSR60 ... PSR105

Rated operational voltage  $U_n$ , 208...600 V AC

Rated control supply voltage,  $U_c$ , 100...240 V AC, 50/60 Hz

IEC			UL/CSA				Type	Order code	Weight pkg (1 pce)			
Rated operational power			Rated operational power				FLA					
230 V	400 V	500 V	200/208 V 220/240 V 440/480 V 550/600 V									
$P_e$	$P_e$	$P_e$	$I_e$	$P_e$	$P_e$	$P_e$	$P_e$			kg	(lb)	
kW	kW	kW	A	hp	hp	hp	hp	A				
0.75	1.5	2.2	3.9	0.5	0.75	2	2	3.4	PSR3-600-70	1SFA896103R7000	0.45	(0.99)
1.5	3	4	6.8	1	1.5	3	5	6.1	PSR6-600-70	1SFA896104R7000	0.45	(0.99)
2.2	4	4	9	2	2	5	7.5	9	PSR9-600-70	1SFA896105R7000	0.45	(0.99)
3	5.5	5.5	12	3	3	7.5	10	11	PSR12-600-70	1SFA896106R7000	0.45	(0.99)
4	7.5	7.5	16	3	5	10	10	15.2	PSR16-600-70	1SFA896107R7000	0.45	(0.99)
5.5	11	15	25	7.5	7.5	15	20	24.2	PSR25-600-70	1SFA896108R7000	0.65	(1.43)
7.5	15	18.5	30	7.5	10	20	25	28	PSR30-600-70	1SFA896109R7000	0.65	(1.43)
7.5	18.5	22	37	10	10	25	30	34	PSR37-600-70	1SFA896110R7000	1.00	(2.20)
11	22	30	45	15	15	30	40	46.2	PSR45-600-70	1SFA896111R7000	1.00	(2.20)
15	30	37	60	20	20	40	50	59.4	PSR60-600-70	1SFA896112R7000	2.20	(4.85)
22	37	45	72	20	25	50	60	68	PSR72-600-70	1SFA896113R7000	2.27	(5.00)
22	45	55	85	25	30	60	75	80	PSR85-600-70	1SFA896114R7000	2.27	(5.00)
30	55	55	105	30	40	75	100	104	PSR105-600-70	1SFA896115R7000	2.27	(5.00)









Rated operational voltage  $U_n$ , 208...600 V AC

Rated control supply voltage,  $U_c$ , 24 V AC/DC, 50/60 Hz

0.75	1.5	2.2	3.9	0.5	0.75	2	2	3.4	PSR3-600-11	1SFA896103R1100	0.45	(0.99)
1.5	3	4	6.8	1	1.5	3	5	6.1	PSR6-600-11	1SFA896104R1100	0.45	(0.99)
2.2	4	4	9	2	2	5	7.5	9	PSR9-600-11	1SFA896105R1100	0.45	(0.99)
3	5.5	5.5	12	3	3	7.5	10	11	PSR12-600-11	1SFA896106R1100	0.45	(0.99)
4	7.5	7.5	16	3	5	10	10	15.2	PSR16-600-11	1SFA896107R1100	0.45	(0.99)
5.5	11	15	25	7.5	7.5	15	20	24.2	PSR25-600-11	1SFA896108R1100	0.65	(1.43)
7.5	15	18.5	30	7.5	10	20	25	28	PSR30-600-11	1SFA896109R1100	0.65	(1.43)
7.5	18.5	22	37	10	10	25	30	34	PSR37-600-11	1SFA896110R1100	1.00	(2.20)
11	22	30	45	15	15	30	40	46.2	PSR45-600-11	1SFA896111R1100	1.00	(2.20)
15	30	37	60	20	20	40	50	59.4	PSR60-600-11	1SFA896112R1100	2.20	(4.85)
22	37	45	72	20	25	50	60	68	PSR72-600-11	1SFA896113R1100	2.27	(5.00)
22	45	55	85	25	30	60	75	80	PSR85-600-11	1SFA896114R1100	2.27	(5.00)
30	55	55	105	30	40	75	100	104	PSR105-600-11	1SFA896115R1100	2.27	(5.00)

## PSR - The compact range

### Accessories

	For softstarter type	Type	Order code	Pkg qty	Weight (1 pce) kg	(lb)
 PSR16-MS116   PSR30-MS132   PSR45-MS165   PSR60-MS165   PSR105-MS495	<b>Connection kit</b>					
	PSR3...16	PSR16-MS116	1SFA896211R1001	1	0.022	(0.049)
	PSR25...30	PSR30-MS132	1SFA896212R1001	1	0.040	(0.088)
	PSR60...105	PSR105-MS495	1SAM501903R1001	1	0.034	(0.075)
	PSR37...45	PSR45-MS165	1SFA896216R1001	1	0.050	(0.110)
	PSR60...72	PSR60-MS165	1SFA896215R1001	1	0.050	(0.110)
 PSR-FAN3-45A   PSR-FAN60-105A	<b>Fan</b>					
	PSR3 ... PSR45	PSR-FAN3-45A	1SFA896311R1001	1	0.010	(0.022)
	PSR60 ... PSR105	PSR-FAN60-105A	1SFA896313R1001	1	0.013	(0.029)
 PSLW	<b>Terminal enlargements</b>					
	PSR60 ... PSR105 Wire range mm <sup>2</sup> 1 x 10...50 mm <sup>2</sup> , 2 x 10...25 mm <sup>2</sup>	PSLW-72	1SFA899002R1072	1	0.150	(0.033)
 PS-FBPA	<b>FieldBusPlug connection accessory</b>					
	PSR3 ... PSR105	PS-FBPA	1SFA896312R1002	1	0.060	(0.132)

# PSR - The compact range

## Technical data

<b>Softstarter types</b>	<b>PSR3</b>	<b>PSR6</b>	<b>PSR9</b>	<b>PSR12</b>	<b>PSR16</b>	<b>PSR25</b>	<b>PSR30</b>	<b>PSR37</b>	<b>PSR45</b>	<b>PSR60</b>	<b>PSR72</b>	<b>PSR85</b>	<b>PSR105</b>
<b>Rated insulation voltage U<sub>i</sub></b>	600 V												
<b>Rated operational voltage U<sub>e</sub></b>	208...600 V +10%/-15%, 50/60 Hz ±5%												
<b>Rated control supply voltage U<sub>s</sub></b>	100...240 V AC, 50/60Hz ±5% or 24 V AC/DC, +10%/-15%,												
<b>Starting capacity at I<sub>e</sub></b>	4 x I <sub>e</sub> for 6 sec.												
<b>Number of starts per hour</b>	See table below for details												
standard	10 <sup>1)</sup>												
with aux. fan	20 <sup>1)</sup>												
<b>Ambient temperature</b>													
during operation	-25...+60 °C (-13...+140 F) <sup>2)</sup>												
during storage	-40...+70 °C (-40...+158 F)												
<b>Maximum altitude</b>	4000 m (13123 ft) <sup>3)</sup>												
<b>Degree of protection</b>													
main circuit	IP20												
control circuit	IP20												
<b>Power consumption: Supply circuit</b>													
at 100...240 V AC	12 VA												
at 24 V AC/DC	5 W												
<b>Max. Power loss at rated I<sub>e</sub></b>	0.7 W	2.9 W	6.5 W	11.5 W	20.5 W	25 W	36 W	5.5 W	8.1 W	3.6 W	5.2 W	7.2 W	6.6 W
<b>Connectable cable area</b>													
main circuit	1 x 0.75...2.5 mm <sup>2</sup> (19...14 AWG)				1 x 2.5...10 mm <sup>2</sup> (14...8 AWG)				1 x 6...35 mm <sup>2</sup> (10...2 AWG)				1 x 10...95 mm <sup>2</sup> (8...4/0 AWG)
	2 x 0.75...2.5 mm <sup>2</sup> (19...14 AWG)				2 x 2.5...10 mm <sup>2</sup> (14...8 AWG)				2 x 6...16 mm <sup>2</sup> (10...6 AWG)				2 x 6...35 mm <sup>2</sup> (10...2 AWG)
control circuit	1 x 0.75...2.5 mm <sup>2</sup> (19...14 AWG)				1 x 0.75...2.5 mm <sup>2</sup> (19...14 AWG)				2 x 0.75...1.5 mm <sup>2</sup> (19...16 AWG)				
	2 x 0.75...2.5 mm <sup>2</sup> (19...14 AWG)				2 x 0.75...1.5 mm <sup>2</sup> (19...16 AWG)								
<b>Signal relays</b>													
for run signal resistive load AC-15 (contactor)	3 A				3 A								
	0.5 A				0.5 A								
for top of ramp signal resistive load AC-15 (contactor)	-				3 A								
	-				0.5 A								
<b>LED</b>													
for On/Ready	Green												
for Run/Top of ramp	Green												
<b>Settings</b>													
Ramp time during start	1...20 sec.												
Ramp time during stop	0...20 sec.												
Initial- and end voltage	40...70%												

<sup>1)</sup> Valid for 50% on time and 50% off time. If other data is required, contact your local ABB office.

<sup>2)</sup> Above 40 °C (104 F) up to max. 60 °C (140 F) reduce the rated current with 0.8% per °C (0.44% per F).

<sup>3)</sup> When used at high altitudes, above 1000 meters (3281 ft) up to 4000 meters (13123 ft), de-rate the rated current using the following formula.

$$[\% \text{ of } I_e = 100 - \frac{x-1000}{150}] \quad x = \text{actual altitude of the softstarter in meter.}$$

### Number of starts per hour using PSR softstarters

Motor current I <sub>e</sub>	Starts/hour without auxiliary fan									Starts/hour with auxiliary fan								
	10	20	30	40	50	60	80	100		10	20	30	40	50	60	80	100	
3 A	PSR3									PSR6								
6 A	PSR6				PSR9					PSR9								
9 A	PSR9			PSR12						PSR16			PSR25					
12 A	PSR12		PSR16			PSR25				PSR30								
16 A	PSR16		PSR25			PSR30				PSR37								
25 A	PSR25		PSR30		PSR37				PSR45			PSR60						
30 A	PSR30		PSR37			PSR45				PSR60			PSR72					
37 A	PSR37		PSR45			PSR60				PSR72		PSR85		PSR105				
45 A	PSR45			PSR60			PSR72		PSR85		PSR105			-				
60 A	PSR60		PSR72		PSR85			PSR105				-						
72 A	PSR72		PSR85		PSR105			-				-						
85 A	PSR85		PSR105			-				-								
105 A	PSR105		-			-				-								

Data based on an ambient temperature of 40° (104 F), starting current of 4 x I<sub>e</sub> and ramp time 6 seconds.  
For more optimized selection or to use PSR for heavy-duty starts, please use the softstarter selection tool.

# PSR - The compact range

## Dimensions

### Main dimensions mm, inches

#### PSR3 ... PSR16

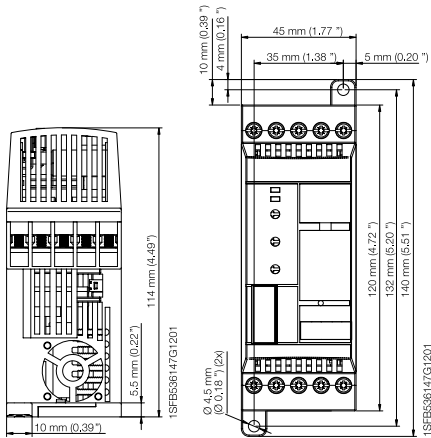

#### PSR25 ... PSR30

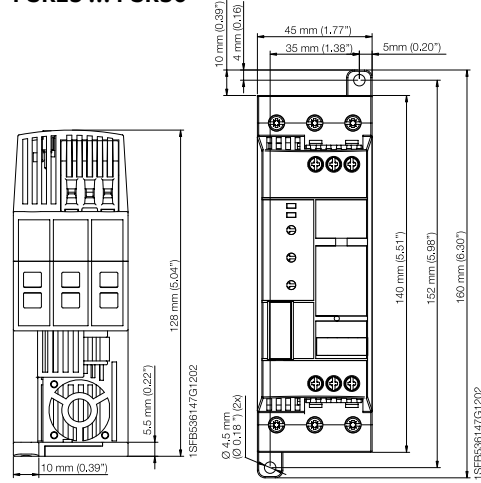

#### PSR37 ... PSR45

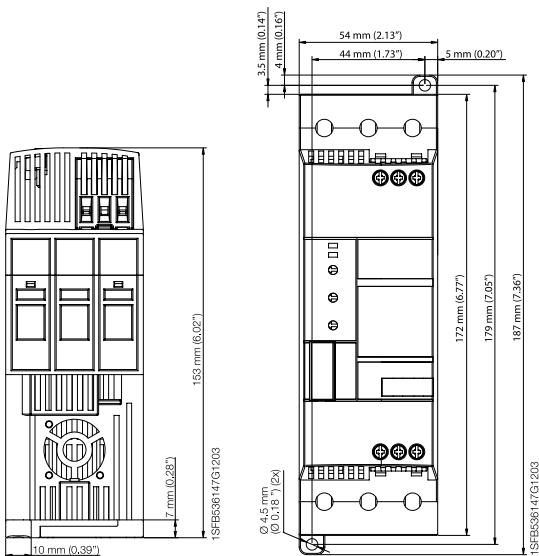

#### PSR60 ... PSR105

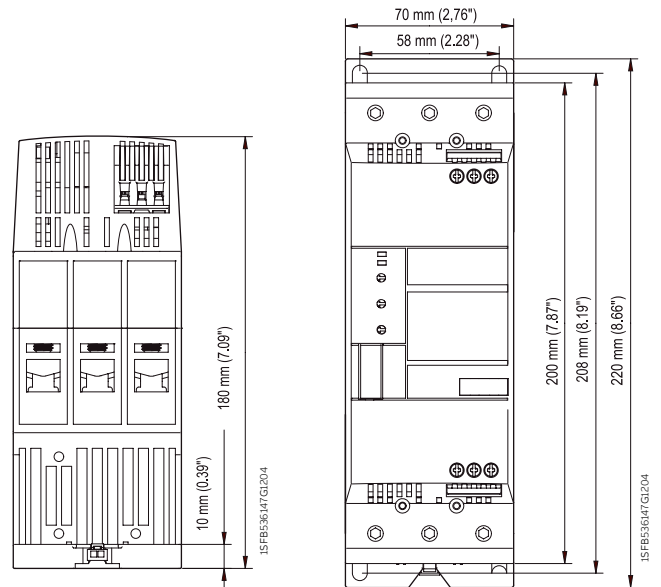

# PSR - The compact range

## Circuit diagrams

### Main dimensions mm, inches

PSR3 ... PSR16 With MMS

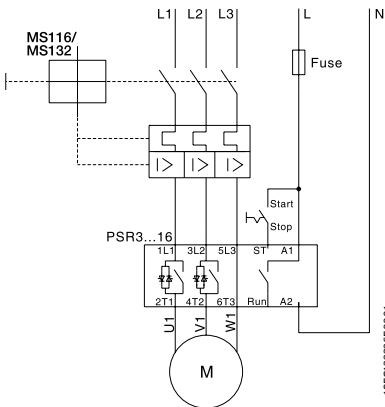

With MMS and auxiliary contact

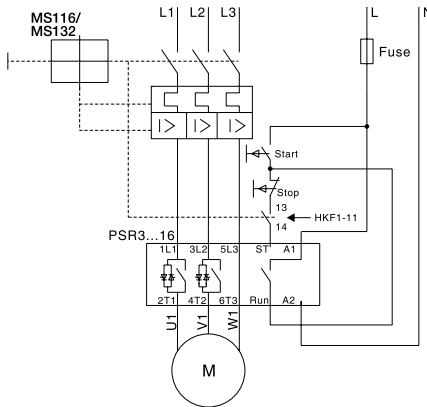

With fuses, contactor and O.L.

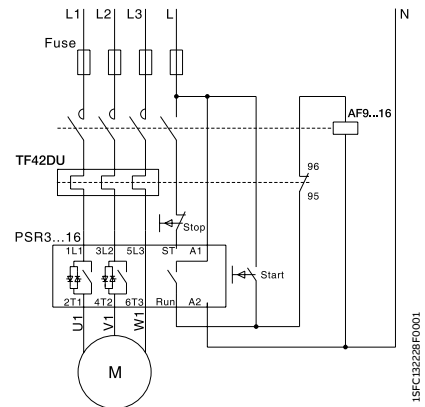

PSR25 ... PSR45 With MMS

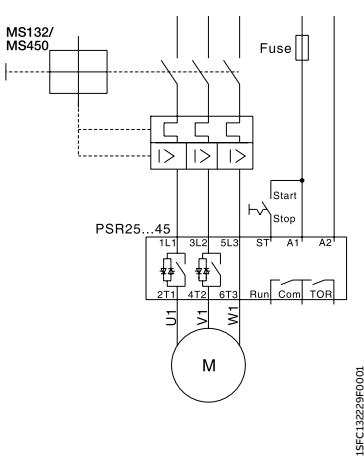

With MMS and auxiliary contact

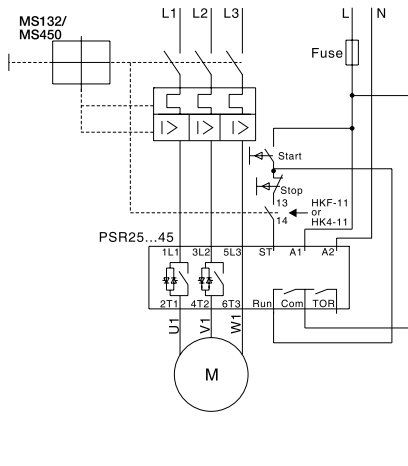

With fuses, contactor and O.L.

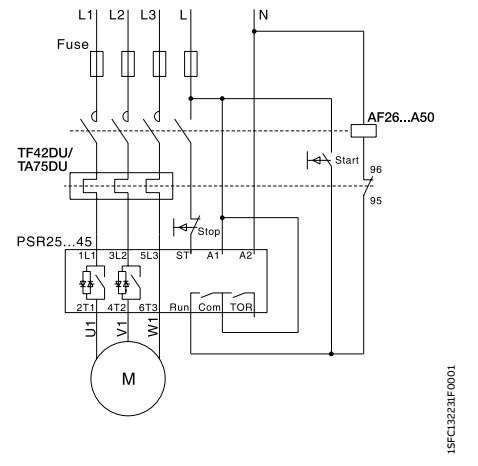

PSR60 ... PSR105 With MMS

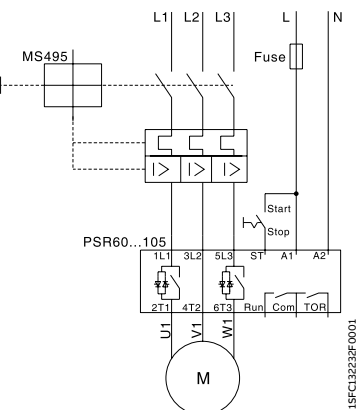

With MMS and auxiliary contact

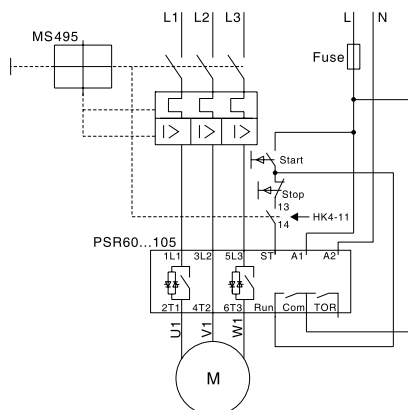

With fuses, contactor and O.L.

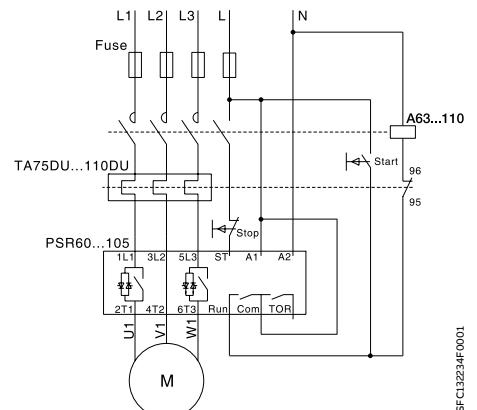



The PSE has been designed to meet the most common requirements from the water segment and is specialized on pump operation. It combines the requested protections with a very compact design and built-in bypass. Remote operation with external keypad or over fieldbus is available as an option.

---

# PSE - The efficient range

<b>26–27</b>	<b>Introduction</b>
<b>28–29</b>	<b>Overview</b>
<b>30–31</b>	<b>ordering details</b>
<b>32</b>	<b>Accessories</b>
<b>33–35</b>	<b>Technical data</b>
<b>36</b>	<b>Dimensions</b>
<b>37</b>	<b>Circuit diagrams</b>

# PSE - The efficient range

## Introduction



- Two-phase controlled
- Operational voltage: 208...600 V AC
- Wide rated control supply voltage: 100...250 V AC, 50/60 Hz
- Rated operational current: 18...370 A
- Voltage ramp and torque control for both start and stop
- Current limit
- Kick-start
- Built-in bypass for energy saving and easy installation
- Coated PCBA protecting from dust, moist and corrosive atmosphere
- Illuminated display that uses symbols to become language neutral
- External keypad rated IP66 (Type 1, 4X,12) as an option
- Fieldbus communication with FieldBusPlug adapter and the FieldBusPlug
- Analog output for display of motor current
- Electronic overload protection
- Underload protection
- Locked rotor protection

### SECURE MOTOR

## Reliability



#### BASIC MOTOR PROTECTION AND CURRENT LIMIT

The PSE includes the most important protections for handling different load situations that can happen to pumps e.g. overload and underload. The current limit gives you more control of the motor during start and allows you to start your motor in weaker networks.

### IMPROVE INSTALLATION

## Efficiency



#### SAVING TIME AND MONEY WITH BUILT-IN BYPASS AND COMPACT DESIGN

On the PSE, the bypass is built in and verified by ABB, saving you time during installation and space in your panel. The keypad is language neutral and illuminated for easy set-up and operation in field. The compact design makes installation fast and easy.

### INCREASE APPLICATION

## Productivity



#### TORQUE CONTROL FOR ELIMINATION OF WATER HAMMERING IN PUMPS

Torque control is the most efficient way to stop a full speed pump. The PSE has a special torque stop ramp that is designed together with a pump manufacturer to eliminate water hammering in an optimal way.



SCREW MOUNTING

PSE is fast easy to install by using screw mounting.



DIGITAL INPUT FOR START, STOP AND RESET

PSE is controlled through digital inputs using the internal 24 V DC source. This allows easy control with e.g. push buttons or relays.



OUTPUT SIGNAL RELAYS FOR RUN, TOP OF RAMP AND EVENT

Three output signal relays for indicating that the motor is running, that the softstarter is in top of ramp and if any event has happened. The relays can be used e.g. with pilot lights or to control a line contactor.



CLEAR MARKINGS ON THE FRONT FOR EASY INSTALLATION

All markings are on the front making it very easy to read after installation.



LED INDICATORS

- Green ready LED  
Flashing - Supply available  
Steady - Main available
- Green run LED  
Flashing - Ramping up/down  
Steady - TOR
- Yellow protection LED
- Red fault LED



ILLUMINATED AND LANGUAGE-NEUTRAL DISPLAY WITH ICONS

The display on PSE uses icons for fast and easy set-up of parameters. Each icon indicates a different parameter to set and makes navigation and setting of parameters easy. Set-up is done by using the four buttons on the keypad.

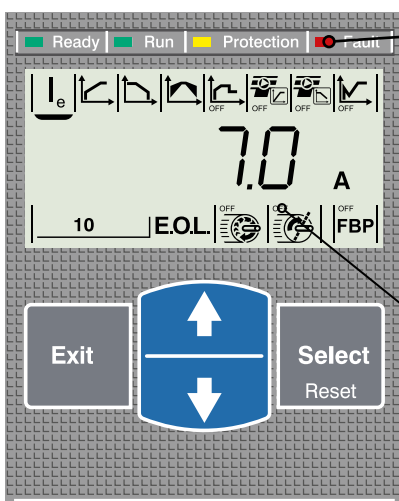

## PSE - The efficient range

### Overview



PSE18 ... PSE105

Normal start In-line connected	PSE18	PSE25	PSE30	PSE37	PSE45	PSE60	PSE72	PSE85	PSE105
(400 V) kW	7.5	11	15	18.5	22	30	37	45	55
IEC, max. A	18	25	30	37	45	60	72	85	106
(440-480 V) hp	10	15	20	25	30	40	50	60	75
UL, max. FLA	18	25	28	34	42	60	68	80	104
<b>400 V, 40 °C</b>									
Using MCCB only, type 1 coordination will be achieved <sup>1)</sup>	<b>MCCB (35 kA)</b>								
	T2N160								T3N250
	<b>MCCB (50 kA)</b>								
	T2S160								T3S250
To achieve type 2 coordination, semi- conductor fuses must be used <sup>1)</sup>	<b>Fuse protection (85 kA), Semiconductor fuses, Bussmann</b>								
	170M1563	170M1564	170M1566	170M1567	170M1568	170M1569	170M1571	170M1572	170M3819
Suitable switch fuse for recommended semi- conductor fuses <sup>1)</sup>	<b>Switch fuse</b>								
	OS32GD			OS63GD			OS125GD		OS250D
The line contactor is not required for the softstarter itself but often used to open if OL trips <sup>1)</sup>	<b>Line contactor</b>								
	AF26	AF30	AF38	AF52	AF65	AF80	AF96	AF116	

<sup>1)</sup> This is an example of coordination. For more examples see: [applications.it.abb.com/SOC](http://applications.it.abb.com/SOC)

## PSE - The efficient range

### Overview



PSE142 ... PSE170



PSE210 ... PSE370

Normal start In-line connected (400 V) kW IEC, max. A (440-480 V) hp UL, max. FLA	PSE142	PSE170	PSE210	PSE250	PSE300	PSE370
	75	90	110	132	160	200
	143	171	210	250	300	370
	100	125	150	200	250	300
	130	169	192	248	302	361
	<b>400 V, 40 °C</b>					
	<b>MCCB (35 kA)</b>					
Using MCCB only, type 1 coordination will be achieved <sup>1)</sup>	T3N250		T4N320	T5N400		T5N630
	<b>MCCB (50 kA)</b>					
	T3S250		T4S320	T5S400		T5S630
To achieve type 2 coordination, semi- conductor fuses must be used <sup>1)</sup>	<b>Fuse protection (85kA), Semiconductor fuses, Bussmann</b>					
	170M5809	170M5810	170M5812	170M5813	170M6812	170M6813
Suitable switch fuse for recommended semi- conductor fuses <sup>1)</sup>	<b>Switch fuse</b>					
	OS400D				OS630D	
The line contactor is not required for the softstarter itself but often used to open if OL trips <sup>1)</sup>	<b>Line contactor</b>					
	AF140	AF190	AF205	AF265	AF305	AF370

<sup>1)</sup> This is an example of coordination. For more examples see: [applications.it.abb.com/SOC](http://applications.it.abb.com/SOC)



## PSE - The efficient range

Normal starts, class 10, in-line, ordering details

### Typical applications:

- Bow thruster
- Centrifugal pump
- Compressor
- Conveyorbelt (short)
- Elevator
- Escalator



If more than 10 starts/h, select one size larger than the standard selection. For a more precise selection, use the online softstarter selection tool available by scanning the shown QR code or using the selection tool available on: [new.abb.com/low-voltage/products/softstarters](http://new.abb.com/low-voltage/products/softstarters)



Rated operational voltage $U_e$ , 208...600 V													
Rated control supply voltage $U_c$ , 100...250 V AC, 50/60 Hz													
IEC			UL/CSA				Type	Order code		Weight (1 pce)			
Rated operational power			Rated operational current										
230 V	400 V	500 V											
$P_e$	$P_e$	$P_e$											
kW	kW	kW	$I_e$	$P_e$	$P_e$	$P_e$	$P_e$	FLA			kg	(lb)	
			A	hp	hp	hp	hp	A					
4	7.5	11	18	5	5	10	15	18	PSE18-600-70	1SFA897101R7000	2.40	(5.29)	
5.5	11	15	25	7.5	7.5	15	20	25	PSE25-600-70	1SFA897102R7000	2.40	(5.29)	
7.5	15	18.5	30	7.5	10	20	25	28	PSE30-600-70	1SFA897103R7000	2.40	(5.29)	
9	18.5	22	37	10	10	25	30	34	PSE37-600-70	1SFA897104R7000	2.40	(5.29)	
11	22	30	45	10	15	30	40	42	PSE45-600-70	1SFA897105R7000	2.40	(5.29)	
15	30	37	60	20	20	40	50	60	PSE60-600-70	1SFA897106R7000	2.40	(5.29)	
18.5	37	45	72	20	25	50	60	68	PSE72-600-70	1SFA897107R7000	2.50	(5.51)	
22	45	55	85	25	30	60	75	80	PSE85-600-70	1SFA897108R7000	2.50	(5.51)	
30	55	75	106	30	40	75	100	104	PSE105-600-70	1SFA897109R7000	2.50	(5.51)	
40	75	90	143	40	50	100	125	130	PSE142-600-70	1SFA897110R7000	4.20	(9.26)	
45	90	110	171	60	60	125	150	169	PSE170-600-70	1SFA897111R7000	4.20	(9.26)	
59	110	132	210	60	75	150	200	192	PSE210-600-70	1SFA897112R7000	12.40	(27.34)	
75	132	160	250	75	100	200	250	248	PSE250-600-70	1SFA897113R7000	13.90	(30.64)	
90	160	200	300	100	100	250	300	302	PSE300-600-70	1SFA897114R7000	13.90	(30.64)	
110	200	250	370	125	150	300	350	361	PSE370-600-70	1SFA897115R7000	13.90	(30.64)	

## PSE - The efficient range

Heavy-duty start, class 30, in-line, ordering details



### Typical applications

- Centrifugal fan
- Conveyor belt (long)
- Crusher
- Mill
- Mixer
- Stirrer









If more than 10 starts/h, select one size larger than the standard selection. For a more precise selection, use the online softstarter selection tool available by scanning the shown QR code or using the selection tool available on: [new.abb.com/low-voltage/products/softstarters](http://new.abb.com/low-voltage/products/softstarters)

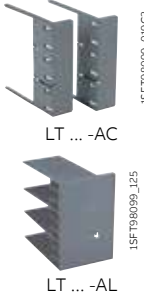

Rated operational voltage U <sub>e</sub> , 208-600 V													
Rated control supply voltage U <sub>s</sub> , 100-250 V AC, 50/60 Hz													
IEC			UL/CSA				Type			Order code		Weight (1 pce)	
Rated operational power			Rated operational current				current						
230 V	400 V	500 V											
P <sub>e</sub>	P <sub>e</sub>	P <sub>e</sub>	I <sub>e</sub>	P <sub>e</sub>	P <sub>e</sub>	P <sub>e</sub>	P <sub>e</sub>	P <sub>e</sub>	FLA				
kW	kW	kW	A	hp	hp	hp	hp	hp	A			kg	(lb)
3	5.5	7.5	12	3	3	7.5	10	11	PSE18-600-70	1SFA897101R7000	2.40	(5.29)	
4	7.5	11	18	5	5	10	15	18	PSE25-600-70	1SFA897102R7000	2.40	(5.29)	
5.5	11	15	25	7.5	7.5	15	20	25	PSE30-600-70	1SFA897103R7000	2.40	(5.29)	
7.5	15	18.5	30	7.5	10	20	25	28	PSE37-600-70	1SFA897104R7000	2.40	(5.29)	
9	18.5	22	37	10	10	25	30	34	PSE45-600-70	1SFA897105R7000	2.40	(5.29)	
11	22	30	45	10	15	30	40	42	PSE60-600-70	1SFA897106R7000	2.40	(5.29)	
15	30	37	60	20	20	40	50	60	PSE72-600-70	1SFA897107R7000	2.50	(5.51)	
18.5	37	45	72	20	25	50	60	68	PSE85-600-70	1SFA897108R7000	2.50	(5.51)	
22	45	55	85	25	30	60	75	80	PSE105-600-70	1SFA897109R7000	2.50	(5.51)	
30	55	75	106	30	40	75	100	104	PSE142-600-70	1SFA897110R7000	4.20	(9.26)	
40	75	90	143	40	50	100	125	130	PSE170-600-70	1SFA897111R7000	4.20	(9.26)	
45	90	110	171	60	60	125	150	169	PSE210-600-70	1SFA897112R7000	12.40	(27.34)	
59	110	132	210	60	75	150	200	192	PSE250-600-70	1SFA897113R7000	13.90	(30.64)	
75	132	160	250	75	100	200	250	248	PSE300-600-70	1SFA897114R7000	13.90	(30.64)	
90	160	200	300	100	100	250	300	302	PSE370-600-70	1SFA897115R7000	13.90	(30.64)	

## PSE - The efficient range

### Accessories

 1SFT98099_095C2 5BB054C2	For softstarter type	Wire range	Tightening torque max.	Type	Order code	Pkg qty	Weight (1 pce)	
		mm <sup>2</sup>	Nm				kg (lb)	
	<b>Cable connectors for Cu cables</b>							
	PSE142 ... PSE170	6...120	14	–	1SDA066917R1	3	0.113 (0.249)	
PSE142 ... PSE170	2 x (50...120)	16	LZ185-2C/120	1SFN074709R1000	3	0.100 (0.220)		
PSE210 ... PSE370	16...300	25	–	1SDA055016R1	3	0.133 (0.293)		
 1SFT98099_01C1	For softstarter type	Wire range	Tightening torque max.	Type	Order code	Pkg qty	Weight (1 pce)	
		mm <sup>2</sup>	Nm				kg (lb)	
	<b>Cable connectors for Al and Cu cables</b>							
PSE142 ... PSE170	95...185	31	–	1SDA054988R1	3	0.078 (0.172)		
PSE210 ... PSE370	185...240	43	–	1SDA055020R1	3	0.133 (0.293)		
 LW... 1SFT98000_011C3	For softstarter type	Dimensions hole ø	bar mm <sup>2</sup>	Type	Order code	Pkg qty	Weight (1 pce)	
		mm <sup>2</sup>					kg (lb)	
	<b>Terminal enlargements</b>							
	PSE18 ... PSE105	6.5	15 x 3	LW110	1SFN074307R1000	1	0.100 (0.220)	
PSE142 ... PSE170	10.5	17.5 x 5	LW185	1SFN074707R1000	1	0.450 (0.992)		
PSE210 ... PSE370	10.5	20 x 5	LW300	1SFN075107R1000	1	1.230 (2.712)		
 LT ... -AC 1SFT98099_019C3 LT ... -AL 1SFT98099_125	For softstarter type		Req. qty	Type	Order code	Pkg qty	Weight (1 pce)	
							kg (lb)	
	<b>Terminal shrouds</b>							
	PSE142 ... PSE170, short for use with cable clamps		2	LT185-AC	1SFN124701R1000	2	0.050 (0.110)	
	PSE142 ... PSE170, long for use with compression lugs		2	LT185-AL	1SFN124703R1000	2	0.220 (0.485)	
PSE210 ... PSE370, short for use with cable clamps		2	LT300-AC	1SFN125101R1000	2	0.070 (0.154)		
PSE210 ... PSE370, long for use with compression lugs		2	LT300-AL	1SFN125103R1000	2	0.280 (0.617)		
 1SFC132328F0002 PSEEK	For softstarter type			Type	Order code	Pkg qty	Weight (1 pce)	
							kg (lb)	
<b>External keypad including a 3m cable</b>								
PSE18 ... PSE370				PSEEK	1SFA897100R1001	1	0.198 (0.437)	
 1SFC132355F0002 PSECA	For softstarter type			Type	Order code	Pkg qty	Weight (1 pce)	
							kg (lb)	
<b>USB cable for Service Engineer Tool</b>								
PSE18 ... PSE370				PSECA	1SFA897201R1001	1	0.130 (0.287)	
 1SFC132168F0001 PS-FBPA	For softstarter type			Type	Order code	Pkg qty	Weight (1 pce)	
							kg (lb)	
<b>FieldBusPlug connection accessory</b>								
PSE18 ... PSE370				PS-FBPA	1SFA896312R1002	1	0.060 (0.132)	

## PSE - The efficient range

Technical data

Tripping curves for the integrated electronic overload protection

PSE has an integrated electronic overload protection that can be set to four different tripping classes. Below you find a curve for each tripping class in cold state.

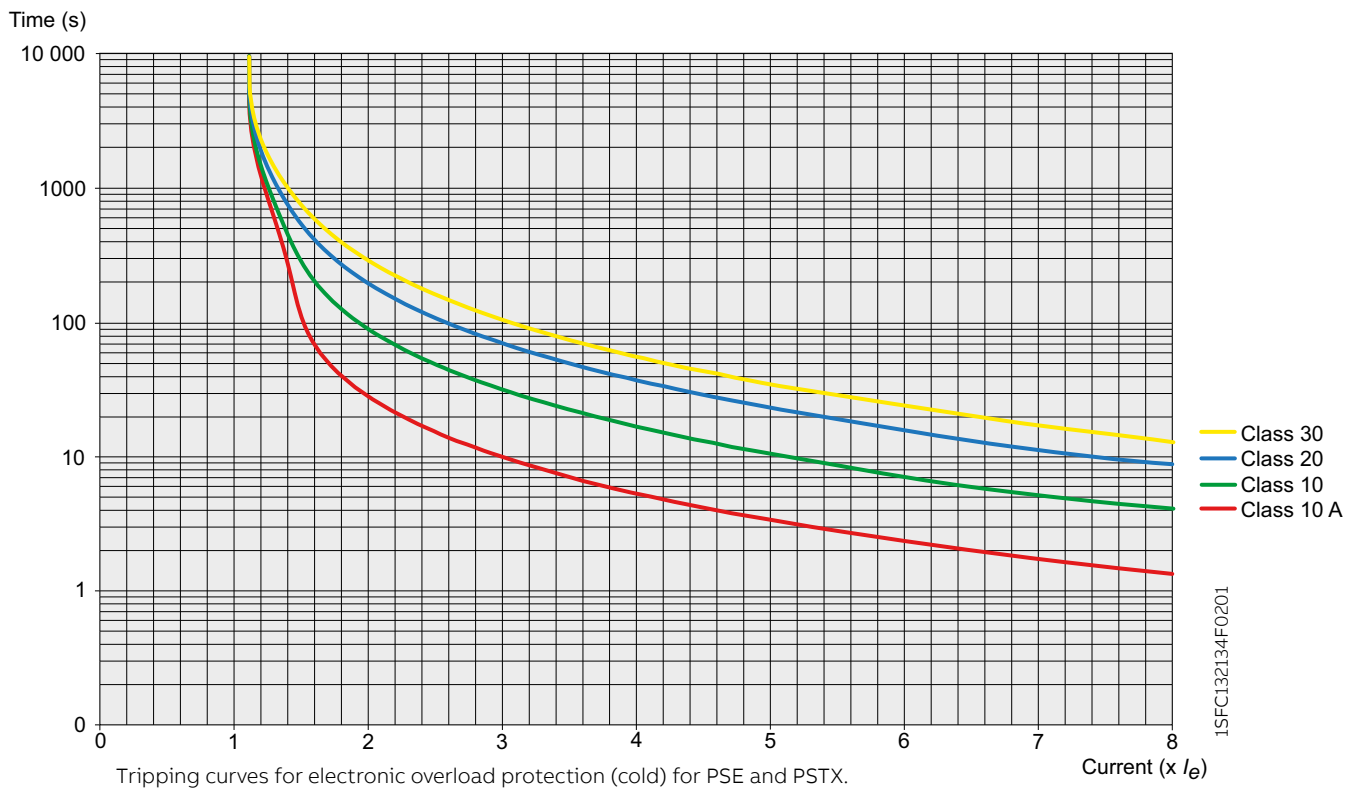

## PSE - The efficient range

### Technical data

Softstarter type		PSE18 ... PSE370
Rated insulation voltage $U_i$		600 V
Rated operational voltage $U_e$		208...600 V +10%/-15%
Rated control supply voltage $U_s$		100...250 V +10%/-15%, 50/60 Hz $\pm$ 10 %
Rated control circuit voltage $U_c$		Internal 24 V DC
Starting capacity at $I_e$		$4 \times I_e$ for 10 sec.
Number of starts per hour		$10^{1)}$
Overload capability	Overload class	10
Ambient temperature	During operation	-25...+60 °C (-13...+140 F) <sup>2)</sup>
	During storage	-40...+70 °C (-40...+158 F)
Maximum Altitude		4000 m (13123 ft) <sup>3)</sup>
Degree of protection	Main circuit	IP00
	Supply and control circuit	IP20
Main circuit	Built-in bypass	Yes
	Cooling system - fan cooled (thermostat controlled)	Yes
HMI for settings	Display	4 7-segments and icons. Illuminated
	Keypad	2 selection keys and 2 navigation keys
Main settings	Setting current	Size dependent
	Ramp time during start	1...30 sec
	Ramp time during stop	0...30 sec
	Initial/end voltage	30...70%
	Current limit	$1.5...7 \times I_e$
	Torque control for start	Yes / No
	Torque control for stop	Yes / No
Signal relays	Kick start	Off, 30...100%
	Number of signal relays	3
	K2	Run signal
	K3	TOR (bypass) signal
	K1	Event signal
	Rated operational voltage $U_e$	250 V AC/24 V DC <sup>4)</sup>
	Rated thermal current $I_{th}$	3 A
Analog output	Rated operational current $I_e$ at AC-15 ( $U_e = 250$ V)	1.5 A
	Output signal reference	4...20 mA
	Type of output signal	1 Amp
Control circuit	Scaling	Fixed at $1.2 \times I_e$
	Number of inputs	3 (start, stop, reset of faults)
Signal indication LED	On / Ready	Green flashing / steady
	Run / TOR	Green flashing / steady
	Protection	Yellow
	Fault	Red
Protections	Electronic overload	Yes (Class 10A, 10, 20, 30)
	Locked rotor protection	Yes
	Underload protection	Yes
Fieldbus connection	Connection for ABB FieldBusPlug	Yes (option)
External keypad	Display	LCD type
	Ambient temperature	
	During operation	-25...+60 °C (-13...+140 F)
	During storage	-40...+70 °C (-40...+158 F)
Degree of protection		IP66

<sup>1)</sup> Valid for 50% on time and 50% off time. If other data is required, contact your local ABB office.

<sup>2)</sup> Above 40 °C (104 F) up to max. 60 °C (140 F) reduce the rated current with 0.6% per °C (0,33% per F).







<sup>3)</sup> When used at high altitudes, above 1000 meters (3281 ft) up to 4000 meters (13123 ft), de-rate the rated current using the following formula. [ % of  $I_e = 100 - \frac{x}{1000} ] \times$  actual altitude of the softstarter in meters.

150

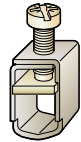
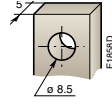
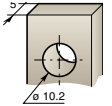
<sup>4)</sup> A common voltage needs to be used for all 3 signal relays.

## PSE - The efficient range

### Technical data

Main terminals		PSE18 ... PSE105	PSE142 ... PSE170	PSE210 ... PSE370
				
	<b>Cu cable - Flexible</b> 1 x mm <sup>2</sup>	2.5...70 mm <sup>2</sup>	6...120 mm <sup>2</sup>	16...300 mm <sup>2</sup>
	Clamp type	Included	1SDA066917R1	1SDA055016R1
	Tightening torque	8 Nm	14 Nm	25 Nm
	<b>Cu cable - Flexible</b> 2 x mm <sup>2</sup>	2.5...70 mm <sup>2</sup>	50...120 mm <sup>2</sup>	-
	Clamp type	Included	1SFN074709R1000	-
	Tightening torque	8 Nm	16 Nm	-
	<b>Cu cable - Stranded</b> 1 x mm <sup>2</sup>	2.5...70 mm <sup>2</sup>	6...120 mm <sup>2</sup>	16...300 mm <sup>2</sup>
	Clamp type	Included	1SDA066917R1	1SDA055016R1
	Tightening torque	8 Nm	14 Nm	25 Nm
	<b>Cu cable - Stranded</b> 2 x mm <sup>2</sup>	2.5...70 mm <sup>2</sup>	50...120 mm <sup>2</sup>	-
	Clamp type	Included	1SFN074709R1000	-
	Tightening torque	8 Nm	16 Nm	-
	<b>Al cable - Stranded</b> 1 x mm <sup>2</sup>	-	95...185 mm <sup>2</sup>	185...240
	Clamp type	-	1SDA054988R1	1SDA055020R1
	Tightening torque	-	31 Nm	43 Nm
	<b>Lugs</b>			
	Width	22 mm (0.866 in)	24 mm (0.945 in)	30 mm (1.181 in)
	Diameter >=	6.5 mm (0.256 in)	8.5 mm (0.335 in)	10.2 mm (0.402 in)
	Tightening torque	9 Nm (80 in lb)	18 Nm (159 in lb)	28 Nm (248 in lb)
<b>Connection capacity acc to UL / CSA 1 x AWG / kcmil</b>		6...2/0	6...300 kcmil	4...400 kcmil
	Clamp type	Included	ATK185	ATK300
	Tightening torque	71 in lb	300 in lb	375 in lb
<b>Connection capacity acc to UL / CSA 2 x AWG / kcmil</b>		-	-	4...500 kcmil
	Clamp type	-	-	ATK300/2
	Tightening torque	-	-	375 in lb
<b>Supply and control circuit</b>				
	Cu cable - Stranded 1 x mm <sup>2</sup>	0.75...2.5 mm <sup>2</sup> (19...14 AWG)		
	Cu cable - Stranded 2 x mm <sup>2</sup>	0.75...1.5 mm <sup>2</sup> (19...16 AWG)		
	Tightening torque	0.5 Nm (4.4 in lb)		

### Fuse ratings and power losses

For softstarter	Current range	Max power loss at rated I <sub>e</sub>	Max fuse rating - main circuit <sup>1)</sup>			Power requirements supply circuit Holding (VA) / Pull-in (VA)
			A	Type	Size	
PSE18	5.4...18.0	0.2	40	170M1563	000	16/19.9
PSE25	7.5...25.0	0.4	50	170M1564	000	16/19.9
PSE30	9.0...30.0	0.5	80	170M1566	000	16/19.9
PSE37	11.1...37.0	0.8	100	170M1567	000	16/19.9
PSE45	13.5...45.0	1.2	125	170M1568	000	16/19.9
PSE60	18.0...60.0	2.2	160	170M1569	000	16/19.9
PSE72	21.6...72.0	3.1	250	170M1571	000	16/19.9
PSE85	25.5...85.0	4.3	315	170M1572	000	16/19.9
PSE105	31.8...106.0	6.6	400	170M3819	1*	16/19.9
PSE142	42.9...143.0	12.1	450	170M5809	2	16/31
PSE170	51.3...171.0	17.6	500	170M5810	2	16/31
PSE210	63.0...210.0	8.8	630	170M5812	2	30/716
PSE250	75.0...250.0	12.5	700	170M5813	2	30/716
PSE300	90.6...302.0	18.0	800	170M6812	3	30/716
PSE370	111.0...370.0	27.4	900	170M6813	3	30/716

<sup>1)</sup> For the supply circuit 6 A delayed, for MCB use C characteristics.

# PSE - The efficient range

## Dimensions

PSE18 ... PSE105

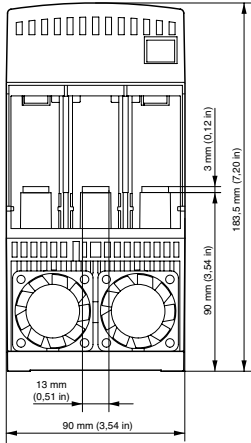

PSE142 ... PSE170

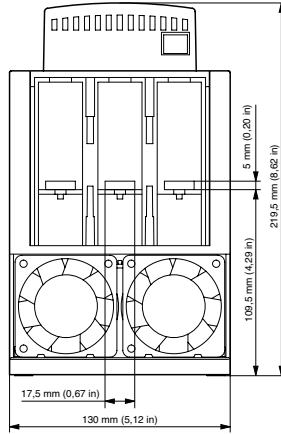

PSE210 ... PSE370

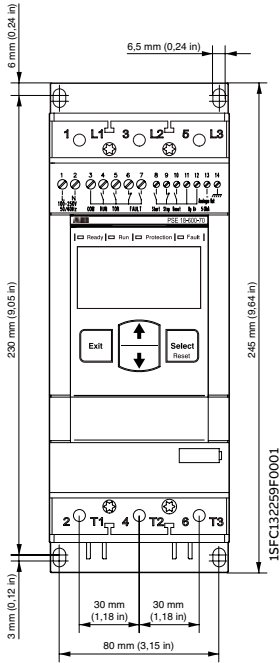
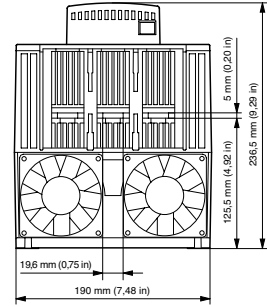

1SFC132259F0001

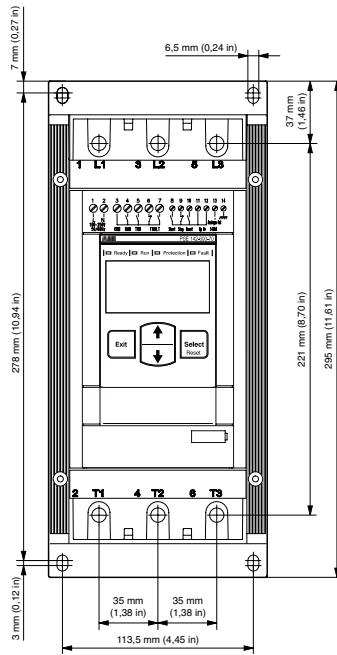

1SFC132260F0001

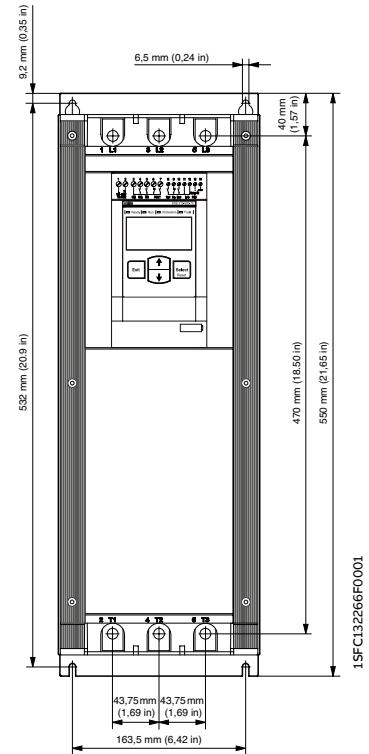

1SFC132266F0001

### PSE external keypad (PSEEK)

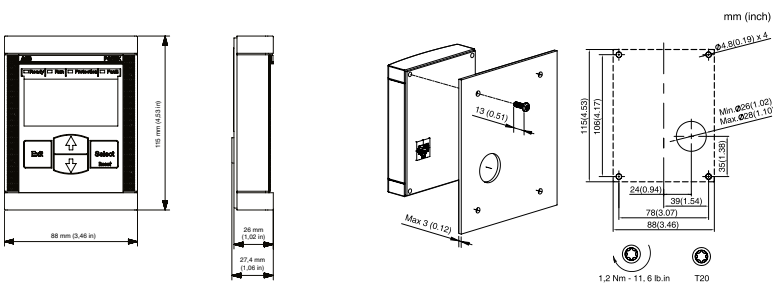

# PSE - The efficient range

## Circuit diagrams

### PSE18 ... PSE370 With MCCB and line contactor

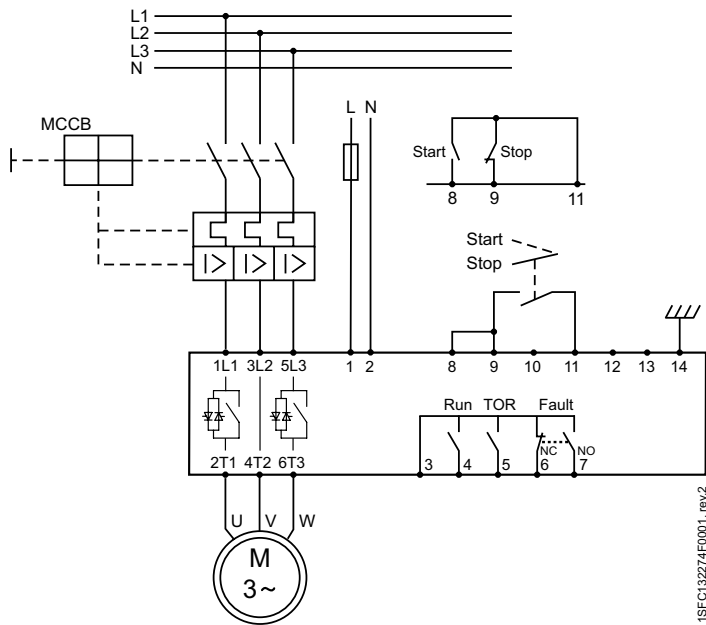

### With fuses and line contactor

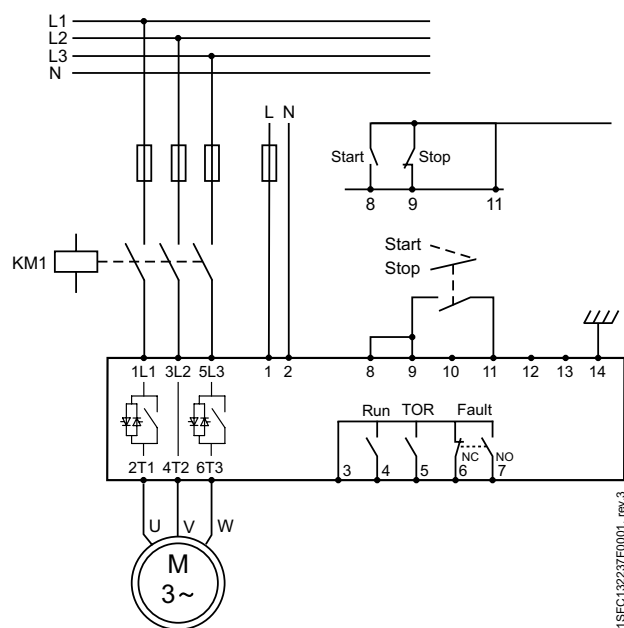



The PSTX combines many years of research and product development with extensive knowledge of application specific requirements and needs. It is our latest advancement in motor control & protection, and it adds new functionality and increased reliability.

---

# PSTX - The advance range

<b>40–41</b>	<b>Introduction</b>
<b>42–43</b>	<b>Overview</b>
<b>44–47</b>	<b>Ordering details</b>
<b>48–49</b>	<b>Accessories</b>
<b>50–53</b>	<b>Technical data</b>
<b>54–55</b>	<b>Dimensions</b>
<b>56–57</b>	<b>Circuit diagrams</b>

# PSTX - The advanced range

## Introduction



- Three-phase controlled
- Operational voltage: 208 – 690 VAC
- Wide rated control supply voltage: 100 – 250 V, 50/60 Hz
- PSTX rated operational current: 30 to 1250 A
- (inside-delta: 2160 A)
- Both in-line and inside-delta connection
- Coated circuit boards
- protecting from dust, moist and corrosive atmosphere
- Detachable keypad rated IP66 (Type 1, 4X,12)
- Graphical display with 17 languages for easy setup and operation
- Built-in bypass for energy saving and easy installation
- Built-in Modbus RTU for monitoring and control
- Support for all major communication protocols
- Analog output for measurement of current, voltage, power factor etc.

### SECURE MOTOR

## Reliability



### COMPLETE MOTOR PROTECTION

The PSTX offers complete motor protection in only one unit and is able to handle both load and network irregularities. PT-100, earth fault protection and over/under voltage protection along with many other functions keep your motor safer than ever.

### THREE TYPES OF CURRENT LIMIT

PSTX offers three types of current limit: standard, dual and ramp. This gives you full control of your motor during start. It also allows you to use your motor in weaker networks.

### IMPROVE INSTALLATION

## Efficiency



### BUILT-IN BYPASS SAVES TIME AND ENERGY

When reaching full speed, the PSTX will activate its bypass. This saves energy while reducing the softstarter's heat generation. On the PSTX, the bypass is built in and verified by ABB, saving you time during installation and space in your panel.

### EASY-TO-USE AND DETACHABLE KEYPAD

A user-friendly and clear display saves you time and resources during both setup and operation. The detachable keypad is standard on all PSTX softstarters.

### INCREASE APPLICATION

## Productivity



### COMPLETE CONTROL OF PUMPS

Time to use your processes to their full potential. The PSTX features many application enhancing features, including torque control: the most efficient way to start and stop pumps. The pump cleaning feature can reverse pump flow and clean out pipes, securing uptime of your pump system.

### JOG WITH SLOW SPEED

The slow speed forward and backward jog feature will make you more flexible when operating e.g. conveyor belts and cranes. The PSTX provides positioning capabilities, letting you take control of your process.



KEYHOLE MOUNTING FOR QUICK INSTALLATION

The PSTX is simple and quick to install using keyhole mounting, saving you valuable time during the installation.



A COMPACT MOTOR STARTING SOLUTION

When your application reaches full speed, a bypass will reduce the softstarter's energy consumption. It also reduces heat generation which means you can save money by reducing the need of added cooling equipment. On the PSTX, the bypass is built in and verified by ABB.



CLEAR MARKINGS ON THE FRONT

With the PSTX, you do not need a manual to handle control circuit connections. With the self-explanatory markings on the front you can verify that the connections are done right. And with basic data on the front, identification is simple without having to take the product down.



CUSTOMIZABLE

The PSTX has 15 pre-installed languages along with options to customize your own specific home screens (up to seven different). You can use your customized home screens to show status information important to your process and hide information that is not.



EASY TO LEARN

A large graphical display along with built-in assistants make learning how to handle the PSTX fun and simple. The interface resembles other interfaces from ABB which will streamline and help with training of field personnel.



DETACHABLE

The PSTX comes with a detachable keypad as standard. It can be placed on your panel door, meaning you do not have to interrupt your process in order to read status information or to change settings.

# PSTX - The advanced range

## Overview



PSTX30... PSTX105



PSTX142... PSTX170

	PSTX30	PSTX37	PSTX45	PSTX60	PSTX72	PSTX85	PSTX105	PSTX142	PSTX170
<b>Normal start</b>									
<b>In-Line connected (400 V) kW</b>	15	18.5	22	30	37	45	55	75	90
<b>IEC, max. A</b>	30	37	45	60	72	85	106	143	171
<b>(440-480 V) hp</b>	20	25	30	40	50	60	75	100	125
<b>UL, max. FLA</b>	28	34	42	60	68	80	104	130	169
<b>400 V, 40 °C</b>									
<b>Using manual motor starter or MCCB, type 1 coordination will be achieved. <sup>1)</sup></b>	<b>MCCB (50 kA)</b>								
	XT2S160							XT4S250	
<b>Using gG fuses, type 1 coordination will be achieved. To achieve type 2 coordination, semiconductor fuses must be used. <sup>1)</sup></b>	<b>Fuse protection (80 kA), Semiconductor fuses, Bussmann</b>								
	170M1567	170M1568	170M1569	170M1571	170M1572	170M3819	170M5810	170M5812	
<b>Suitable switch fuse for the recommended semiconductor fuses. <sup>1)</sup></b>	<b>Switch fuse</b>								
	OS32G	OS63G			OS125G		OS250	OS400	
<b>The line contactor is not required for the softstarter itself but often used to open if OL trips <sup>1)</sup></b>	<b>Line contactor</b>								
	AF30	AF38	AF52	AF65	AF80	AF96	AF116	AF140	AF190

<sup>1)</sup> This is an example of coordination. For more examples see: [applications.it.abb.com/SOC](http://applications.it.abb.com/SOC)

## PSTX - The advanced range

### Overview



PSTX210... PSTX370



PSTX470... PSTX570



PSTX720... PSTX840



PSTX1050... PSTX1250

	PSTX210	PSTX250	PSTX300	PSTX370	PSTX470	PSTX570	PSTX720	PSTX840	PSTX1050	PSTX1250
<b>Normal start</b>										
<b>In-Line connected (400 V) kW</b>	110	132	160	200	250	315	400	450	560	710
<b>IEC, max. A (440-480 V) hp</b>	210	250	300	370	470	570	720	840	1050	1250
<b>UL, max. FLA</b>	150	200	250	300	400	500	600	700	900	1000
	192	248	302	361	480	590	720	840	1062	1250

400 V, 40 °C

Using manual motor starter or MCCB, type 1 coordination will be achieved.<sup>1)</sup>

MCCB (50 kA)

T4S320	T5S400	T5S630	T7S800	T7S1250	E2.2N 2000
--------	--------	--------	--------	---------	------------

Using gG fuses, type 1 coordination will be achieved. To achieve type 2 coordination, semiconductor fuses must be used.<sup>1)</sup>

Fuse protection (80 kA), Semiconductor fuses, Bussmann

170M5812	170M5813	170M6812	170M6813	170M6814	170M8554	170M6018	170M6020	170M6021
----------	----------	----------	----------	----------	----------	----------	----------	----------

Suitable switch fuse for the recommended semiconductor fuses.<sup>1)</sup>

Switch fuse

OS400	OS630	OS800	-
-------	-------	-------	---

The line contactor is not required for the softstarter itself but often used to open if OL trips.<sup>1)</sup>

Line contactor

AF205	AF265	AF305	AF370	AF460	AF580	AF750	AF1350	AF1650	-
-------	-------	-------	-------	-------	-------	-------	--------	--------	---

<sup>1)</sup> This is an example of coordination. For more examples see: [applications.it.abb.com/SOC](http://applications.it.abb.com/SOC)



# PSTX - The advanced range

Normal starts, class 10, in-line,  
Ordering details

### Typical applications

- Bow thruster
- Centrifugal pump
- Compressor
- Conveyor belt (short)
- Elevator



For a more precise selection, use the online softstarter selection tool available by scanning the shown QR code or using the selection tool available on: [new.abb.com/low-voltage/products/softstarters](http://new.abb.com/low-voltage/products/softstarters)



PSTX30 ... PSTX105   PSTX142 ... PSTX170   PSTX210 ... PSTX370   PSTX470 ... PSTX570   PSTX720 ... PSTX840   PSTX1050 ... PSTX1250

Rated operational voltage Ue, 208...600 V , Rated control supply voltage Us, 100...250 V AC, 50/60 Hz													
IEC			UL/CSA				Type		Order code		Weight (1 pce)		
Rated operational power			Rated operational current										
400V	500V	690V	200/208V 220/240V 440/480V 550/600V										
Pe kW	Pe kW	Pe kW	Ie A	Pe hp	Pe hp	Pe hp	Pe hp	FLA A			kg	(lb)	
15	18.5	-	30	7.5	10	20	25	28	PSTX30-600-70	1SFA898103R7000	6.10	(13.45)	
18.5	22	-	37	10	10	25	30	34	PSTX37-600-70	1SFA898104R7000	6.10	(13.45)	
22	25	-	45	10	15	30	40	42	PSTX45-600-70	1SFA898105R7000	6.10	(13.45)	
30	37	-	60	20	20	40	50	60	PSTX60-600-70	1SFA898106R7000	6.10	(13.45)	
37	45	-	72	20	25	50	60	68	PSTX72-600-70	1SFA898107R7000	6.10	(13.45)	
45	55	-	85	25	30	60	75	80	PSTX85-600-70	1SFA898108R7000	6.10	(13.45)	
55	75	-	106	30	40	75	100	104	PSTX105-600-70	1SFA898109R7000	6.10	(13.45)	
75	90	-	143	40	50	100	125	130	PSTX142-600-70	1SFA898110R7000	9.60	(21.16)	
90	110	-	171	50	60	125	150	169	PSTX170-600-70	1SFA898111R7000	9.60	(21.16)	
110	132	-	210	60	75	150	200	192	PSTX210-600-70	1SFA898112R7000	12.70	(27.99)	
132	160	-	250	75	100	200	250	248	PSTX250-600-70	1SFA898113R7000	12.70	(27.99)	
160	200	-	300	100	100	250	300	302	PSTX300-600-70	1SFA898114R7000	12.70	(27.99)	
200	257	-	370	125	150	300	350	361	PSTX370-600-70	1SFA898115R7000	12.70	(27.99)	
250	315	-	470	150	200	400	500	480	PSTX470-600-70	1SFA898116R7000	25.00	(55.12)	
315	400	-	570	200	200	500	600	590	PSTX570-600-70	1SFA898117R7000	25.00	(55.12)	
400	500	-	720	250	300	600	700	720	PSTX720-600-70	1SFA898118R7000	46.20	(101.85)	
450	600	-	840	300	350	700	800	840	PSTX840-600-70	1SFA898119R7000	46.20	(101.85)	
560	730	-	1050	400	450	900	1000	1062	PSTX1050-600-70	1SFA898120R7000	64.20	(141.54)	
710	880	-	1250	400	500	1000	1200	1250	PSTX1250-600-70	1SFA898121R7000	64.70	(142.64)	

Rated operational voltage Ue, 208...690 V , Rated control supply voltage Us, 100...250 V AC, 50/60 Hz													
IEC			UL/CSA				Type		Order code		Weight (1 pce)		
Rated operational power			Rated operational current										
400V	500V	690V	200/208V 220/240V 440/480V 550/600V										
Pe kW	Pe kW	Pe kW	Ie A	Pe hp	Pe hp	Pe hp	Pe hp	FLA A			kg	(lb)	
15	18.5	25	30	7.5	10	20	25	28	PSTX30-690-70	1SFA898203R7000	6.10	(13.45)	
18.5	22	30	37	10	10	25	30	34	PSTX37-690-70	1SFA898204R7000	6.10	(13.45)	
22	25	37	45	10	15	30	40	42	PSTX45-690-70	1SFA898205R7000	6.10	(13.45)	
30	37	55	60	20	20	40	50	60	PSTX60-690-70	1SFA898206R7000	6.10	(13.45)	
37	45	59	72	20	25	50	60	68	PSTX72-690-70	1SFA898207R7000	6.10	(13.45)	
45	55	75	85	25	30	60	75	80	PSTX85-690-70	1SFA898208R7000	6.10	(13.45)	
55	75	90	106	30	40	75	100	104	PSTX105-690-70	1SFA898209R7000	6.10	(13.45)	
75	90	132	143	40	50	100	125	130	PSTX142-690-70	1SFA898210R7000	9.60	(21.16)	
90	110	160	171	50	60	125	150	169	PSTX170-690-70	1SFA898211R7000	9.60	(21.16)	
110	132	184	210	60	75	150	200	192	PSTX210-690-70	1SFA898212R7000	12.70	(27.99)	
132	160	220	250	75	100	200	250	248	PSTX250-690-70	1SFA898213R7000	12.70	(27.99)	
160	200	257	300	100	100	250	300	302	PSTX300-690-70	1SFA898214R7000	12.70	(27.99)	
200	257	355	370	125	150	300	350	361	PSTX370-690-70	1SFA898215R7000	12.70	(27.99)	
250	315	450	470	150	200	400	500	480	PSTX470-690-70	1SFA898216R7000	25.00	(55.12)	
315	400	560	570	200	200	500	600	590	PSTX570-690-70	1SFA898217R7000	25.00	(55.12)	
400	500	710	720	250	300	600	700	720	PSTX720-690-70	1SFA898218R7000	46.20	(101.85)	
450	600	800	840	300	350	700	800	840	PSTX840-690-70	1SFA898219R7000	46.20	(101.85)	
560	730	1000	1050	400	450	900	1000	1062	PSTX1050-690-70	1SFA898220R7000	64.20	(141.54)	
710	880	1200	1250	400	500	1000	1200	1250	PSTX1250-690-70	1SFA898221R7000	64.70	(142.64)	

# PSTX - The advanced range

Heavy-duty, class 30, in-line,  
Ordering details



### Typical applications

- Centrifugal fan
- Conveyor belt (long)
- Crusher
- Mill
- Mixer
- Stirrer



For a more precise selection, use the online softstarter selection tool available by scanning the shown QR code or using the selection tool available on: [new.abb.com/low-voltage/products/softstarters](http://new.abb.com/low-voltage/products/softstarters)



PSTX30 ... PSTX105   PSTX142 ... PSTX170   PSTX210 ... PSTX370   PSTX470 ... PSTX570   PSTX720 ... PSTX840   PSTX1050 ... PSTX1250

Rated operational voltage $U_e$ , 208...600 V, Rated control supply voltage $U_s$ , 100...250 V AC, 50/60 Hz												
IEC			UL/CSA				Type		Order code		Weight (1 pce)	
Rated operational power			Rated operational current				FLA					
400V	500V	690V	200/208 V		220/240 V		440/480 V		550/600 V			
$P_e$ kW	$P_e$ kW	$P_e$ kW	$I_e$ A	$P_e$ hp	$P_e$ hp	$P_e$ hp	$P_e$ hp	FLA A			kg	(lb)
11	15	-	22	5	7.5	15	20	25	PSTX30-600-70	1SFA898103R7000	6.10	(13.45)
15	18.5	-	30	7.5	10	20	25	28	PSTX37-600-70	1SFA898104R7000	6.10	(13.45)
18.5	22	-	37	10	10	25	30	34	PSTX45-600-70	1SFA898105R7000	6.10	(13.45)
22	25	-	45	10	15	30	40	42	PSTX60-600-70	1SFA898106R7000	6.10	(13.45)
30	37	-	60	20	20	40	50	60	PSTX72-600-70	1SFA898107R7000	6.10	(13.45)
37	45	-	72	20	25	50	60	68	PSTX85-600-70	1SFA898108R7000	6.10	(13.45)
45	55	-	85	25	30	60	75	80	PSTX105-600-70	1SFA898109R7000	6.10	(13.45)
55	75	-	106	30	40	75	100	104	PSTX142-600-70	1SFA898110R7000	9.60	(21.16)
75	90	-	143	40	50	100	125	130	PSTX170-600-70	1SFA898111R7000	9.60	(21.16)
90	110	-	171	50	60	125	150	169	PSTX210-600-70	1SFA898112R7000	12.70	(27.99)
110	132	-	210	60	75	150	200	192	PSTX250-600-70	1SFA898113R7000	12.70	(27.99)
132	160	-	250	75	100	200	250	248	PSTX300-600-70	1SFA898114R7000	12.70	(27.99)
160	200	-	300	100	100	250	300	302	PSTX370-600-70	1SFA898115R7000	12.70	(27.99)
200	257	-	370	125	150	300	350	361	PSTX470-600-70	1SFA898116R7000	25.00	(55.12)
250	315	-	470	150	200	400	500	480	PSTX570-600-70	1SFA898117R7000	25.00	(55.12)
315	400	-	570	200	200	500	600	590	PSTX720-600-70	1SFA898118R7000	46.20	(101.85)
400	500	-	720	250	300	600	700	720	PSTX840-600-70	1SFA898119R7000	46.20	(101.85)
450	600	-	840	300	350	700	800	840	PSTX1050-600-70	1SFA898120R7000	64.20	(141.54)
560	730	-	1050	400	450	900	1000	1062	PSTX1250-600-70	1SFA898121R7000	64.70	(142.64)

Rated operational voltage $U_e$ , 208...690 V, Rated control supply voltage $U_s$ , 100...250 V AC, 50/60 Hz												
IEC			UL/CSA				Type		Order code		Weight (1 pce)	
Rated operational power			Rated operational current				FLA					
400V	500V	690V	200/208 V		220/240 V		440/480 V		550/600 V			
$P_e$ kW	$P_e$ kW	$P_e$ kW	$I_e$ A	$P_e$ hp	$P_e$ hp	$P_e$ hp	$P_e$ hp	FLA A			kg	(lb)
11	15	18.5	22	5	7.5	15	20	25	PSTX30-690-70	1SFA898203R7000	6.10	(13.45)
15	18.5	25	30	7.5	10	20	25	28	PSTX37-690-70	1SFA898204R7000	6.10	(13.45)
18.5	22	30	37	10	10	25	30	34	PSTX45-690-70	1SFA898205R7000	6.10	(13.45)
22	25	37	44	10	15	30	40	42	PSTX60-690-70	1SFA898206R7000	6.10	(13.45)
30	37	55	60	20	20	40	50	60	PSTX72-690-70	1SFA898207R7000	6.10	(13.45)
37	45	59	72	20	25	50	60	68	PSTX85-690-70	1SFA898208R7000	6.10	(13.45)
45	55	75	85	25	30	60	75	80	PSTX105-690-70	1SFA898209R7000	6.10	(13.45)
55	75	90	106	30	40	75	100	104	PSTX142-690-70	1SFA898210R7000	9.60	(21.16)
75	90	132	143	40	50	100	125	130	PSTX170-690-70	1SFA898211R7000	9.60	(21.16)
90	110	160	171	50	60	125	150	169	PSTX210-690-70	1SFA898212R7000	12.70	(27.99)
110	132	184	210	60	75	150	200	192	PSTX250-690-70	1SFA898213R7000	12.70	(27.99)
132	160	220	250	75	100	200	250	248	PSTX300-690-70	1SFA898214R7000	12.70	(27.99)
160	200	257	300	100	100	250	300	302	PSTX370-690-70	1SFA898215R7000	12.70	(27.99)
200	257	355	370	125	150	300	350	361	PSTX470-690-70	1SFA898216R7000	25.00	(55.12)
250	315	450	470	150	200	400	500	480	PSTX570-690-70	1SFA898217R7000	25.00	(55.12)
315	400	560	570	200	200	500	600	590	PSTX720-690-70	1SFA898218R7000	46.20	(101.85)
400	500	710	720	250	300	600	700	720	PSTX840-690-70	1SFA898219R7000	46.20	(101.85)
450	600	800	840	300	350	700	800	840	PSTX1050-690-70	1SFA898220R7000	64.20	(141.54)
560	730	1000	1050	400	450	900	1000	1062	PSTX1250-690-70	1SFA898221R7000	64.70	(142.64)

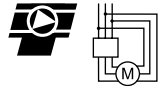

# PSTX - The advanced range

Normal starts, class 10, inside delta, ordering details

### Typical applications:

- Bow thruster
- Centrifugal pump
- Compressor
- Conveyor belt (short)
- Elevator



For a more precise selection, use the online softstarter selection tool available by scanning the shown QR code or using the selection tool available on: [new.abb.com/low-voltage/products/softstarters](http://new.abb.com/low-voltage/products/softstarters)



Rated operational voltage $U_e$ , 208...600 V, Rated control supply voltage $U_s$ , 100...250 V AC, 50/60 Hz													
IEC				UL/CSA				Type		Order code		Weight (1 pce)	
Rated operational power				Rated operational current				Type		Order code		Weight (1 pce)	
400 V 500 V 690 V				200/208V 220/240V 440/480V 550/600V									
$P_e$	$P_e$	$P_e$	$I_e$	$P_e$	$P_e$	$P_e$	$P_e$	FLA			kg	(lb)	
kW	kW	kW	A	hp	hp	hp	hp	A					
25	30	-	52	10	15	30	40	48	PSTX30-600-70	1SFA898103R7000	6.10	(13.45)	
30	37	-	64	15	20	40	50	58	PSTX37-600-70	1SFA898104R7000	6.10	(13.45)	
37	45	-	76	20	25	50	60	72	PSTX45-600-70	1SFA898105R7000	6.10	(13.45)	
55	75	-	105	30	40	75	100	103	PSTX60-600-70	1SFA898106R7000	6.10	(13.45)	
59	80	-	124	30	40	75	100	117	PSTX72-600-70	1SFA898107R7000	6.10	(13.45)	
75	90	-	147	40	50	100	125	138	PSTX85-600-70	1SFA898108R7000	6.10	(13.45)	
90	110	-	181	60	60	150	150	180	PSTX105-600-70	1SFA898109R7000	6.10	(13.45)	
132	160	-	245	75	75	150	200	225	PSTX142-600-70	1SFA898110R7000	9.60	(21.16)	
160	200	-	300	75	100	200	250	292	PSTX170-600-70	1SFA898111R7000	9.60	(21.16)	
184	250	-	360	100	125	250	300	332	PSTX210-600-70	1SFA898112R7000	12.70	(27.99)	
220	295	-	430	150	150	350	450	429	PSTX250-600-70	1SFA898113R7000	12.70	(27.99)	
257	355	-	515	150	200	450	500	523	PSTX300-600-70	1SFA898114R7000	12.70	(27.99)	
355	450	-	640	200	250	500	600	625	PSTX370-600-70	1SFA898115R7000	12.70	(27.99)	
450	600	-	814	250	300	600	700	830	PSTX470-600-70	1SFA898116R7000	25.00	(55.12)	
540	700	-	987	300	350	700	800	1020	PSTX570-600-70	1SFA898117R7000	25.00	(55.12)	
710	880	-	1247	400	500	1000	1200	1240	PSTX720-600-70	1SFA898118R7000	46.20	(101.85)	
800	1000	-	1455	500	600	1200	1500	1450	PSTX840-600-70	1SFA898119R7000	46.20	(101.85)	
1000	1250	-	1810	600	700	1500	1800	1830	PSTX1050-600-70	1SFA898120R7000	64.20	(141.54)	
1200	1500	-	2160	800	900	1800	2000	2160	PSTX1250-600-70	1SFA898121R1000	64.70	(142.64)	

Rated operational voltage $U_e$ , 208...690 V, Rated control supply voltage $U_s$ , 100...250 V AC, 50/60 Hz													
25	30	45	52	10	15	30	40	48	PSTX30-690-70	1SFA898203R7000	6.10	(13.45)	
30	37	55	64	15	20	40	50	58	PSTX37-690-70	1SFA898204R7000	6.10	(13.45)	
37	45	59	76	20	25	50	60	72	PSTX45-690-70	1SFA898205R7000	6.10	(13.45)	
55	75	90	105	30	40	75	100	103	PSTX60-690-70	1SFA898206R7000	6.10	(13.45)	
59	80	110	124	30	40	75	100	117	PSTX72-690-70	1SFA898207R7000	6.10	(13.45)	
75	90	132	147	40	50	100	125	138	PSTX85-690-70	1SFA898208R7000	6.10	(13.45)	
90	110	160	181	60	60	150	150	180	PSTX105-690-70	1SFA898209R7000	6.10	(13.45)	
132	160	220	245	75	75	150	200	225	PSTX142-690-70	1SFA898210R7000	9.60	(21.16)	
160	200	257	300	75	100	200	250	292	PSTX170-690-70	1SFA898211R7000	9.60	(21.16)	
184	250	315	360	100	125	250	300	332	PSTX210-690-70	1SFA898212R7000	12.70	(27.99)	
220	295	400	430	150	150	350	450	429	PSTX250-690-70	1SFA898213R7000	12.70	(27.99)	
257	355	500	515	150	200	450	500	523	PSTX300-690-70	1SFA898214R7000	12.70	(27.99)	
355	450	600	640	200	250	500	600	625	PSTX370-690-70	1SFA898215R7000	12.70	(27.99)	
450	600	800	814	250	300	600	700	830	PSTX470-690-70	1SFA898216R7000	25.00	(55.12)	
540	700	960	987	300	350	700	800	1020	PSTX570-690-70	1SFA898217R7000	25.00	(55.12)	
710	880	1200	1247	400	500	1000	1200	1240	PSTX720-690-70	1SFA898218R7000	46.20	(101.85)	
800	1000	1400	1455	500	600	1200	1500	1450	PSTX840-690-70	1SFA898219R7000	46.20	(101.85)	
1000	1250	1700	1810	600	700	1500	1800	1830	PSTX1050-690-70	1SFA898220R7000	64.20	(141.54)	
1200	1500	2000	2160	800	900	1800	2000	2160	PSTX1250-690-70	1SFA898221R7000	64.70	(142.64)	

# PSTX - The advanced range

Normal starts, class 30, inside delta, ordering details



**Typical applications:**

- Centrifugal fan
- Conveyor belt (long)
- Crusher
- Mill
- Mixer
- Stirrer



For a more precise selection, use the online softstarter selection tool available by scanning the shown QR code or using the selection tool available on: [new.abb.com/low-voltage/products/softstarters](http://new.abb.com/low-voltage/products/softstarters)







PSTX30 ... PSTX105   PSTX142 ... PSTX170   PSTX210 ... PSTX370   PSTX470 ... PSTX570   PSTX720 ... PSTX840   PSTX1050 ... PSTX1250

Rated operational voltage $U_e$ , 208...600 V, Rated control supply voltage $U_s$ , 100...250 V AC, 50/60 Hz													
IEC				UL/CSA				Type		Order code		Weight	
Rated operational power				Rated operational current				Type		Order code		Weight (1 pce)	
400 V 500 V 690 V				200/208V 220/240V 440/480V 550/ 600V									
$P_e$	$P_e$	$P_e$	$I_e$	$P_e$	$P_e$	$P_e$	$P_e$	$P_e$	FLA			kg	(lb)
kW	kW	kW	A	hp	hp	hp	hp	hp	A				
18.5	25	-	42	7.5	10	25	30	34	PSTX30-600-70	1SFA898103R7000	6.10	(13.45)	
25	30	-	52	10	15	30	40	48	PSTX37-600-70	1SFA898104R7000	6.10	(13.45)	
30	37	-	64	15	20	40	50	58	PSTX45-600-70	1SFA898105R7000	6.10	(13.45)	
37	45	-	76	20	25	50	60	72	PSTX60-600-70	1SFA898106R7000	6.10	(13.45)	
55	75	-	105	30	40	75	100	103	PSTX72-600-70	1SFA898107R7000	6.10	(13.45)	
59	80	-	124	30	40	75	100	117	PSTX85-600-70	1SFA898108R7000	6.10	(13.45)	
75	90	-	147	40	50	100	125	138	PSTX105-600-70	1SFA898109R7000	6.10	(13.45)	
90	110	-	181	60	60	150	150	180	PSTX142-600-70	1SFA898110R7000	9.60	(21.16)	
132	160	-	245	75	75	150	200	225	PSTX170-600-70	1SFA898111R7000	9.60	(21.16)	
160	200	-	300	75	100	200	250	292	PSTX210-600-70	1SFA898112R7000	12.70	(27.99)	
184	250	-	360	100	125	250	300	332	PSTX250-600-70	1SFA898113R7000	12.70	(27.99)	
220	295	-	430	150	150	350	450	429	PSTX300-600-70	1SFA898114R7000	12.70	(27.99)	
257	355	-	515	150	200	450	500	523	PSTX370-600-70	1SFA898115R7000	12.70	(27.99)	
355	450	-	640	200	250	500	600	625	PSTX470-600-70	1SFA898116R7000	25.00	(55.12)	
450	600	-	814	250	300	600	700	830	PSTX570-600-70	1SFA898117R7000	25.00	(55.12)	
540	700	-	987	300	350	700	800	1020	PSTX720-600-70	1SFA898118R7000	46.20	(101.85)	
710	880	-	1247	400	500	1000	1200	1240	PSTX840-600-70	1SFA898119R7000	46.20	(101.85)	
800	1000	-	1455	500	600	1200	1500	1450	PSTX1050-600-70	1SFA898120R7000	64.20	(141.54)	
1000	1250	-	1810	600	700	1500	1800	1830	PSTX1250-600-70	1SFA898121R7000	64.70	(142.64)	

Rated operational voltage $U_e$ , 208...690 V, Rated control supply voltage $U_s$ , 100...250 V AC, 50/60 Hz													
$P_e$	$P_e$	$P_e$	$I_e$	$P_e$	$P_e$	$P_e$	$P_e$	$P_e$	FLA			kg	(lb)
kW	kW	kW	A	hp	hp	hp	hp	hp	A				
18.5	25	37	42	7.5	10	25	30	34	PSTX30-690-70	1SFA898203R7000	6.10	(13.45)	
25	30	45	52	10	15	30	40	48	PSTX37-690-70	1SFA898204R7000	6.10	(13.45)	
30	37	55	64	15	20	40	50	58	PSTX45-690-70	1SFA898205R7000	6.10	(13.45)	
37	45	59	76	20	25	50	60	72	PSTX60-690-70	1SFA898206R7000	6.10	(13.45)	
55	75	90	105	30	40	75	100	103	PSTX72-690-70	1SFA898207R7000	6.10	(13.45)	
59	80	110	124	30	40	75	100	117	PSTX85-690-70	1SFA898208R7000	6.10	(13.45)	
75	90	132	147	40	50	100	125	138	PSTX105-690-70	1SFA898209R7000	6.10	(13.45)	
90	110	160	181	60	60	150	150	180	PSTX142-690-70	1SFA898210R7000	9.60	(21.16)	
132	160	220	245	75	75	150	200	225	PSTX170-690-70	1SFA898211R7000	9.60	(21.16)	
160	200	257	300	75	100	200	250	292	PSTX210-690-70	1SFA898212R7000	12.70	(27.99)	
184	250	315	360	100	125	250	300	332	PSTX250-690-70	1SFA898213R7000	12.70	(27.99)	
220	295	400	430	150	150	350	450	429	PSTX300-690-70	1SFA898214R7000	12.70	(27.99)	
257	355	500	515	150	200	450	500	523	PSTX370-690-70	1SFA898215R7000	12.70	(27.99)	
355	450	600	640	200	250	500	600	625	PSTX470-690-70	1SFA898216R7000	25.00	(55.12)	
450	600	800	814	250	300	600	700	830	PSTX570-690-70	1SFA898217R7000	25.00	(55.12)	
540	700	960	987	300	350	700	800	1020	PSTX720-690-70	1SFA898218R7000	46.20	(101.85)	
710	880	1200	1247	400	500	1000	1200	1240	PSTX840-690-70	1SFA898219R7000	46.20	(101.85)	
800	1000	1400	1455	500	600	1200	1500	1450	PSTX1050-690-70	1SFA898220R7000	64.20	(141.54)	
1000	1250	1700	1810	600	700	1500	1800	1830	PSTX1250-690-70	1SFA898221R7000	64.70	(142.64)	





## PSTX - The advanced range

### Accessories

For softstarter type		Wire range	Tightening torque max.	Type	Order code	Pkg qty	Weight (1 pce)	
		mm <sup>2</sup>	Nm				kg	(lb)
 1SFT98099-095C2 SB8054C2 LZ...	<b>Cable connectors for Cu cables</b>							
	PSTX142 ... PSTX170	6-120	8	-	1SDA066917R1	3	0.113	(0.249)
	PSTX142 ... PSTX170	2 x (50-95)	16	LZ185-2C/120	1SFN074709R1000	3	0.300	(0.661)
	PSTX210 ... PSTX370	16-240	25	-	1SDA055016R1	3	0.133	(0.293)
	PSTX210 ... PSTX370	2 x (70-185)	22	OZXB4	1SCA022194R0890	3	0.570	(1.257)
	PSTX470 ... PSTX570	2 x (120-240)	35	-	1SDA013922R1	3	0.570	(1.257)
	PSTX570 ... PSTX1050	3 x (70-185)	45	-	1SDA013956R1	3	0.570	(1.257)
	<b>Cable connectors for Al cables</b>							
	PSTX142 ... PSTX170	95-185	31	-	1SDA054988R1	3	0.078	(0.172)
	PSTX210 ... PSTX370	185-240	43	-	1SDA055020R1	3	0.133	(0.293)
PSTX470 ... PSTX1050	2 x (120-240)	31	-	1SDA023380R0001	3	0.110	(0.243)	
For softstarter type		Dimensions hole ø	bar mm	Type	Order code	Pkg qty	Weight (1 pce)	
		mm <sup>2</sup>					kg	(lb)
 LX...	<b>Terminal extensions</b>							
	PSTX142 ... PSTX170	8.5	17.5 x 5	LX205	1SFN074810R1000	1	0.250	(5.551)
	PSTX210 ... PSTX370	10.5	20 x 5	LX370	1SFN075410R1000	1	0.350	(0.772)
	PSTX470 ... PSTX570	10.5	25 x 5	LX460	1SFN075710R1000	1	0.500	(1.102)
	PSTX720 ... PSTX840	13	40 x 6	LX750	1SFN076110R1003	1	0.850	(1.874)
 LW...	<b>Terminal enlargements</b>							
	PSTX30 ... PSTX105	6.5	15 x 3	LW110	1SFN074307R1000	1	0.100	(0.220)
	PSTX142 ... PSTX170	10.5	17.5 x 5	LW205	1SFN074807R1000	1	0.250	(5.551)
	PSTX210 ... PSTX370	10.5	20 x 5	LW370	1SFN075407R1000	1	0.450	(0.992)
	PSTX470 ... PSTX570	10.5	25 x 5	LW460	1SFN075707R1000	1	0.730	(1.609)
	PSTX720 ... PSTX840	13	40 x 6	LW750	1SFN076107R1000	1	1.230	(2.712)
For softstarter type			Req. qty	Type	Order code	Pkg qty	Weight (1 pce)	
							kg	(lb)
 PSLE460	<b>Terminal nut washer</b>							
	PSTX142 ... PSTX170		6	LL205-30	1SFN074811R1000	6	0.200	(0.441)
	PSTX210 ... PSTX370		6	LL370-30	1SFN075411R1000	6	0.300	(0.661)
	PSTX210 ... PSTX370		2	PSLE-300	1SFA899221R1003	2	0.300	(0.661)
	PSTX470 ... PSTX570		6	PSLE460	1SFA899221R1004	6	0.600	(1.323)
	PSTX720 ... PSTX840		6	PSLE750	1SFA899221R1005	6	0.750	(1.653)
 LT ... -AC LT ... -C LT ... -AL LT ... -L	<b>Terminal shrouds</b>							
	PSTX142 ... PSTX170, short for use with cable clamps		2	LT205-30C	1SFN124801R1000	2	0,050	(0.110)
	PSTX142 ... PSTX170, long for use with compression lugs		2	LT205-30L	1SFN124803R1000	2	0.220	(0.485)
	PSTX210 ... PSTX370, short for use with cable clamps		2	LT370-30C	1SFN125401R1000	2	0.035	(0.077)
	PSTX210 ... PSTX370, long for use with compression lugs		2	LT370-30L	1SFN125403R1000	2	0.280	(0.617)
	PSTX210 ... PSTX370, long and deep for use with extending cable clamps, ATK300/2 and OZXB4		2	LT370-30D	1SFN125406R1000	2	0.150	(0.331)
	PSTX470 ... PSTX570, short for use with cable clamps		2	LT460-AC	1SFN125701R1000	2	0.100	(0.220)
	PSTX470 ... PSTX570, long for use with compression lugs		2	LT460-AL	1SFN125703R1000	2	0.800	(1.764)
	PSTX720 ... PSTX840, short for use with cable clamps		2	LT750-AC	1SFN126101R1000	2	0.120	(0.265)
	PSTX720 ... PSTX840, long for use with compression lugs		2	LT750-AL	1SFN126103R1000	2	0.825	(1.819)

## PSTX - The advanced range

### Accessories

For softstarter type		Type	Order code	Pkg Weight qty (1 pce)	
				kg	(lb)
		<b>Anybus connection accessory for communication protocol</b>			
<b>DeviceNet</b>		Anybus suitable for PSTX30 ... PSTX1250			
		Profibus	AB-PROFIBUS-1	1SFA899300R1001	1 0.042 (0.093)
		DeviceNet	AB-DEVICENET-1	1SFA899300R1002	1 0.042 (0.093)
		Modbus-RTU	AB-MODBUS-RTU-1	1SFA899300R1003	1 0.042 (0.093)
<b>Profibus Modbus-RTU</b>		EtherNet/IP (1-port)	AB-ETHERNET-IP-1	1SFA899300R1005	1 0.042 (0.093)
		EtherNet/IP (2-port)	AB-ETHERNET-IP-2	1SFA899300R1006	1 0.042 (0.093)
		Modbus/TCP (1-port)	AB-MODBUS-TCP-1	1SFA899300R1007	1 0.042 (0.093)
		Modbus/TCP (2-port)	AB-MODBUS-TCP-2	1SFA899300R1008	1 0.042 (0.093)
<b>EtherNet/IP (1-port) Modbus/TCP (1-port)</b>		Profinet (2-port)	AB-PROFINET-2	1SFA899300R1010	1 0.042 (0.093)
		<b>FieldBusPlug connection accessory</b>			
		PSTX30 ... PSTX1250	PS-FBPA	1SFA896312R1002	1 0.060 (0.132)
		ABB's FieldBusPlug suitable for all sizes, see latest softstarter catalog.			
<b>EtherNet/IP (2-port) Modbus/TCP (2-port)</b>		I/O module, 24 V DC digital input			
<b>Profinet (2-port)</b>		PSTX30 ... PSTX1250	DX111-FBP.0	1SAJ611000R0101	1 0.220 (0.485)

## PSTX - The advanced range

### Technical data

<b>Softstarter type</b>	PSTX30 ... PSTX1250		
<b>Rated insulation voltage U<sub>i</sub></b>	690V		
<b>Rated operational voltage U<sub>e</sub></b>	208...600 V, 208...690V +10% / -15%, 50/60Hz ±10%		
<b>Rated control supply voltage U<sub>s</sub></b>	100...250 V +10% / -15%, 50/60Hz ±10%		
<b>Rated control circuit voltage U<sub>c</sub></b>	Internal or external 24 V DC		
<b>Starting capacity at I<sub>e</sub></b>	4 x I <sub>e</sub> for 10 sec.		
<b>Number of starts per hour</b>	10 for PSTX30 ... PSTX370 <sup>1)</sup>	6 for PSTX470 ... PSTX1250 <sup>1)</sup>	
<b>Overload capability</b>	Overload class	10	
<b>Ambient temperature</b>	During operation	-25...+60 °C, (-13...+140 F) <sup>2)</sup>	
	During storage	-40...+70 °C, (-40...+158 F)	
<b>Maximum altitude</b>	4000 m (13123 ft) <sup>3)</sup>		
<b>Degree of protection</b>	Main circuit	-	
	Supply and control circuit	IP20	
<b>Main circuit</b>	Built-in bypass contactor	Yes	
	Cooling system - Fan cooled	Yes (thermostat controlled)	
<b>HMI for settings</b>	Display	LCD type, graphical	
<b>(Human Machine Interface)</b>	Languages	Arabic, Chinese, Czech, Dutch, English, Finnish, French, German, Greek, Indonesian, Italian, Polish, Portuguese, Russian, Spanish, Swedish and Turkish	
	Keypad	2 selection keys, 4 navigation keys, start key, stop key, info key and remote/local key	
<b>Signal relays</b>	Number of programmable signal relays	3 (each relay can be programmed to None, Run, Top of ramp, Event group 0-6, Sequence 1-3 Run, Sequence 1-3 Top of ramp or Run reverse)	
	K4	Default as Run signal	
	K5	Default as Top of Ramp (Bypass) signal	
	K6	Default as Event group 0 (Faults)	
	Rated operational voltage, U <sub>e</sub>	250 V AC/24 V DC	
	Rated thermal current I <sub>th</sub>	5 A	
<b>Analog output</b>	Rated operational current I <sub>e</sub> at AC-15 (U <sub>e</sub> =250 V)	1.5 A	
	Output signal reference	0...10 V, 0...10 mA, 0...20 mA, 4...20 mA	
	Type of output signal	Motor current (A), Main voltage (V), Active power (kW), Active power (HP), Reactive power (kVar), Apparant power (kVArh), Active energy (kWh), Reactive energy (kVArh), cos phi, Motor temperature (%), Thyristor temperature (%), Motor voltage (%), Main frequency (Hz), PT100 temperature (centigrade), PTC resistance (Ohm)	
<b>Control circuit</b>	Number of inputs	2 (start, stop)	
	Number of additional programmable inputs	3 (each input can be programmed to: None, Reset, Enable, Slow speed forward (Jog), Slow speed reverse (Jog), Motor heating, Stand still brake, Start reverse, User defined protection, Emergency mode (active high), Emergency mode (active low), Fieldbus disable control, Start 1, Start 2, Start 3, Switch to remote control or Cancel brake)	
<b>Signalling indication LED</b>	Ready	Green	
	Run	Green	
	Fault	Red	
	Protection	Yellow	
<b>External keypad</b>	Detachable keypad	Yes	
	Display	LCD type, graphical	
	Ambient temperature		
	During operation	-25...+60 °C, (-13...+140 F)	
	During storage	-40...+70 °C, (-40...+158 F)	
	Degree of protection	IP66 (Type 1, 4X, 12)	
<b>Start and stop functions</b>	Soft start with voltage ramp	Yes	
	Soft stop with voltage ramp	Yes	
	Soft start with torque control	Yes	
	Soft stop with torque control	Yes	
	Kick start	Yes	
	Full voltage start	Yes	
	Sequence start	Yes, 3 different sets of settings	
	Current limit	Yes	
	Dual current limit	Yes	
	Current limit ramp	Yes	
	Torque limit	Yes	
	Pre-start function	Yes (Motor heating or Stand still brake)	
	Jog with slow speed, forward and reverse	Yes (3 speed levels)	
	Start reverse (external contactors)	Yes	
	Dynamic brake	Yes	
	<b>Field bus connection</b>	Built-in Modbus RTU	Yes
		Connection for Anybus	Yes
Connection for ABB FieldBusPlug		Yes, with adapter	

<sup>1)</sup> Valid for normal start (class 10) for 50% on time and 50% off time. If other data is required, contact your local ABB office.

<sup>2)</sup> Above 40 °C (104 F) up to max. 60 °C (140 F) reduce the rated current with 0,8% per °C (0,44% per F).

<sup>3)</sup> When used at high altitudes, above 1000 meters (3281 ft) up to 4000 meters (13123 ft), de-rate the rated current using the following formula.

[ % of I<sub>e</sub> = 100 -  $\frac{x-1000}{1000}$  ] x = actual altitude of the softstarter in meter, [ % of I<sub>e</sub> = 100 -  $\frac{x-3280}{3280}$  ] x = actual altitude of the softstarter in feet. For de-rating of voltage, contact your local ABB office.

## PSTX - The advanced range

### Technical data

Softstarter type		PSTX30 ... PSTX1250
<b>Protections</b>	Electronic overload protection, EOL	Yes (Class 10A, 10, 20, 30)
	Dual overload (separate overload for start and run)	Yes
	PTC connection	Yes
	PT-100 connection	Yes
	Locked rotor protection	Yes
	Current underload protection	Yes
	Current imbalance protection	Yes
	Power factor underload protection	Yes
	Under voltage protection	Yes
	Over voltage protection	Yes
	Voltage imbalance protection	Yes
	Earth fault protection / ground fault protection	Yes
	Phase reversal protection	Yes
	24 V output protection	Yes
	Frequency range protection	Yes
	Bypass open protection	Yes
	User defined protection	Yes
	Too long current limit protection	Yes
	HMI failure protection	Yes
	Fieldbus failure protection	Yes
	Extension IO failure protection	Yes
Max number of starts/hour	Yes	
Too long start time protection	Yes	
<b>Warnings</b>	Current underload warning	Yes
	Current imbalance warning	Yes
	Voltage imbalance warning	Yes
	Thyristor overload warning (SCR)	Yes
	Electronic overload Time-to-trip	Yes
	Short circuit warning (for Limp mode)	Yes
	Over voltage warning	Yes
	Under voltage warning	Yes
	Power factor underload warning	Yes
	Locked rotor warning	Yes
	Faulty fan warning	Yes
	THD(U) - Total Harmonic Distortion warning	Yes
	Motor runtime limit warning	Yes
	Phase loss warning (for stand by)	Yes
EOL warning	Yes	
<b>External faults detection</b>	Phase loss	Yes
	Hight current	Yes
	Low control supply voltage	Yes
	Faulty usage (e.g. using limp mode inside-delta)	Yes
	Faulty connection	Yes
Bad network quality		Yes
		Yes
<b>Internal faults detection</b>	Thyristor overload	Yes
	Short circuit	Yes
	Open circuit thyristor or gate	Yes
	Heat sink over temperature	Yes
	Shunt fault	Yes
<b>PTC input</b>	Switch off resistance	2825 ohm $\pm$ 20%
	Switch on resistance	1200 ohm $\pm$ 20%
<b>Other functions</b>	Real time clock	Yes
	Event log	Yes
	Emergency mode	Yes
	Automatic restart	Yes
	Secure settings	Yes
	Keypad password	Yes
	Electronic overload Time-to-cool	Yes
	Thyristor runtime measurement	Yes
	Auto phase sequence detection	Yes
	Electricity metering	Yes
	Motor heating	Yes
	Stand still brake	Yes
	Voltage sags detection	Yes
	Limp mode with two-phase motor control if one set of thyristors is shorted	Yes

For all functions and features see installation and commissioning manual, 1SFC132081M0201 available on [new.abb.com/low-voltage/products/softstarters](http://new.abb.com/low-voltage/products/softstarters).

# PSTX - The advanced range

## Technical data

### Fuse ratings and power losses

For softstarter	Current range	Max power loss at rated $I_e$	Max fuse rating - main circuit <sup>1)2)</sup> Bussmann fuses, DIN43 620 (Knife)			Power requirements supply circuit Holding (VA) / Pull-in (VA)
			A	Type	Size	
Type	A	W	A	Type	Size	
PSTX30	9.0...30.0	0.8	100	170M1567	000	49/51
PSTX37	11.1...37.0	1.2	125	170M1568	000	49/51
PSTX45	13.5...45.0	1.8	160	170M1569	000	49/51
PSTX60	18.0...60.0	3.2	160	170M1569	000	49/51
PSTX72	21.6...72.0	4.7	250	170M1571	000	49/51
PSTX85	22.5...85.0	6.5	315	170M1572	000	49/51
PSTX105	31.8...106.0	10	400	170M3819	1*	49/51
PSTX142	42.9...143.0	18	500	170M5810	2	49/53
PSTX170	51.3...171.0	26	630	170M5812	2	49/53
PSTX210	63.0...210.0	48	630	170M5812	2	56/276
PSTX250	75.0...250.0	68	700	170M5813	2	56/276
PSTX300	90.0...300.0	97	800	170M6812	3	56/276
PSTX370	111.0...370.0	148	900	170M6813	3	56/276
PSTX470	141.0...470.0	99	900	170M6813	3	67/434
PSTX570	171.0...570.0	146	1000	170M6814	3	67/434
PSTX720	216.0...720.0	78	1250	170M8554	3	61/929
PSTX840	252.0...840.0	106	1500	170M6018	3	61/929
PSTX1050 <sup>3)</sup>	315.0...1050.0	165	1800	170M6020	3	68/929
PSTX1250 <sup>3)4)</sup>	375.0...1250.0	234	2000	170M6021	3	68/929

- <sup>1)</sup> For the supply circuit 6 A delayed, for MCB use C characteristics.
- <sup>2)</sup> For inside delta connection the fuses shall be placed inside the delta. Contact ABB for more information.
- <sup>3)</sup> 170M6019 with fuse rating 1600 A should be used for 690 V version.
- <sup>4)</sup> For 690 V version, Bussmann fuses are only available for motors with rated current up to 1150 A.

### PSTX Integrated bypass ratings

Softstarter	PSTX470	PSTX570	PSTX720	PSTX840	PSTX1050	PSTX1250
Integrated contactor	AF370			AF750		AF1250
AC-3 rating at 400 V (A)	370			750		-
IEC AC-3 Rated operational power at 400 V (kW)	200			400		-
UL/CSA 3-phase motor rating at 480 V (hp)	300			600		-



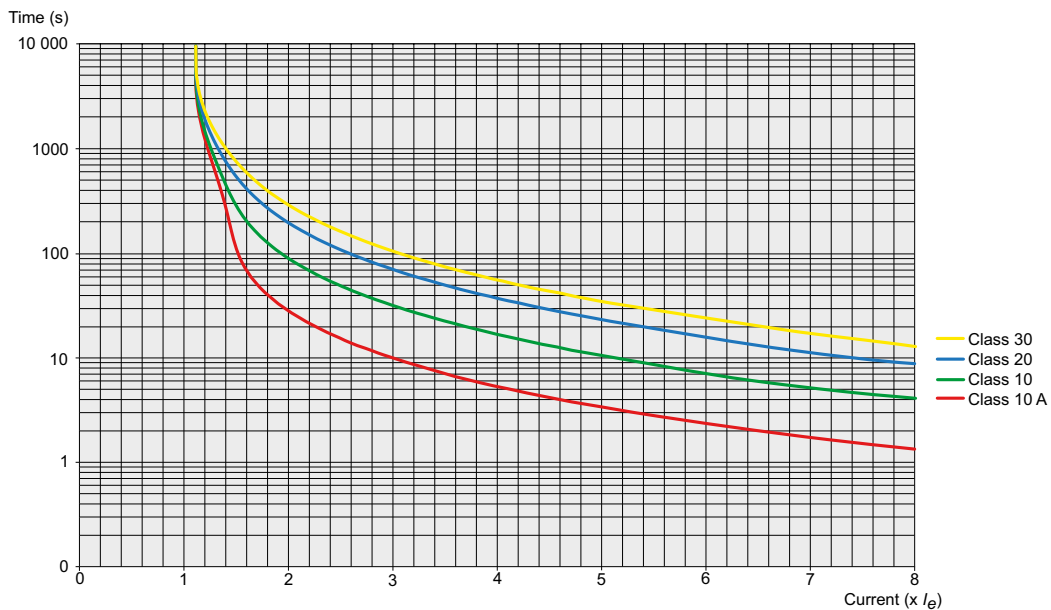





Tripping curves for the integrated electronic overload protection. All units have an integrated electronic overload protection that can be set to four different tripping classes. Below you find a curve for each tripping class in cold state. These tripping curves are valid for PSTX.

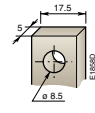
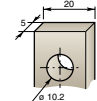
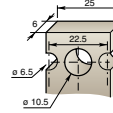
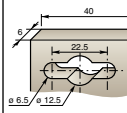
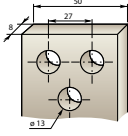

Tripping curves for electronic overload protection (cold) for PSE and PSTX.

## PSTX - The advanced range

### Technical data

Main terminals		PSTX30 ... PSTX105	PSTX142 ... PSTX170	PSTX210 ... PSTX370	PSTX470 ... PSTX570	PSTX720 ... PSTX1050	PSTX1250
							
	Cu cable - flexible	1 x mm <sup>2</sup>	10...70 mm <sup>2</sup>	6...120 mm <sup>2</sup>	16...240 mm <sup>2</sup>	-	-
	Clamp type	Included	1SDA06691R1	1SDA055016R1	-	-	-
	Tightening torque	8 Nm	14 Nm	25 Nm	-	-	-
	Cu cable - flexible	2 x mm <sup>2</sup>	6...35 mm <sup>2</sup>	50...95 mm <sup>2</sup>	70...185 mm <sup>2</sup>	-	-
	Clamp type	Included	LZ185-2C/120	OZXB4 <sup>1)</sup>	-	-	-
	Tightening torque	8 Nm	16 Nm	22 Nm	-	-	-
	Cu cable - Stranded	1 x mm <sup>2</sup>	10...95 mm <sup>2</sup>	6...150 mm <sup>2</sup>	16...300 mm <sup>2</sup>	-	-
	Clamp type	Included	1SDA06691R1	1SDA055016R1	-	-	-
	Tightening torque	8 Nm	14 Nm	25 Nm	-	-	-
	Cu cable - Stranded	2 x mm <sup>2</sup>	6...35 mm <sup>2</sup>	50...120 mm <sup>2</sup>	70...185 mm <sup>2</sup>	120...240 mm <sup>2</sup>	-
	Clamp type	Included	LZ185-2C/120	OZXB4 <sup>1)</sup>	1SDA013922R1	-	-
	Tightening torque	8 Nm	16 Nm	22 Nm	35 Nm	-	-
	Cu cable - Stranded	3 x mm <sup>2</sup>	-	-	-	70...185 mm <sup>2</sup>	-
	Clamp type	-	-	-	-	1SDA013956R1	-
	Tightening torque	-	-	-	-	45 Nm	-
	Al cable - Stranded	1 x mm <sup>2</sup>	-	95...185 mm <sup>2</sup>	185...240 mm <sup>2</sup>	-	-
	Clamp type	-	-	1SDA0549881R1	1SDA055020R1	-	-
	Tightening torque	-	-	31 Nm	43 Nm	-	-
	Al cable - Stranded	2 x mm <sup>2</sup>	-	-	-	120...240 mm <sup>2</sup>	-
	Clamp type	-	-	-	-	1SDA023380R1	-
	Tightening torque	-	-	-	-	31 Nm	-
	Lugs	Width ≤	24 mm (0.945 in)	32 mm (1.260 in)	47 mm (1.850 in)	50 mm (1.969 in)	50 mm (1.969 in)
		Diameter ≥	8 mm (0.355 in)	10.2 mm (0.402 in)	10.5 mm (0.413 in)	12.5 mm (0.492 in)	13 mm (0.519 in)
		Tightening torque	18 Nm (160 in lb)	28 Nm (248 in lb)	35 Nm (310 in lb)	45 Nm (398 in lb)	45 Nm (398 in lb)
Connection capacity acc to UL / CSA 1 x AWG / kcmil		6...2/0	6...300 kcmil	4...400 kcmil	-	-	-
	Clamp type	Included	ATK185	ATK300	-	-	-
	Tightening torque	71 in lb	300 in lb	375 in lb	-	-	-
Connection capacity acc to UL / CSA 2 x AWG / kcmil		-	-	4...500 kcmil	2/0...500 kcmil	2/0...500 kcmil	-
	Clamp type	-	-	ATK300/2 <sup>2)</sup>	ATK580/2	ATK580/2	-
	Tightening torque	-	-	375 in lb	375 in lb	375 in lb	-
Connection capacity acc to UL / CSA 3 x AWG / kcmil		-	-	-	2/0...500 kcmil	2/0...500 kcmil	-
	Clamp type	-	-	-	ATK750/3	ATK750/3	-
	Tightening torque	-	-	-	375 in lb	375 in lb	-
Supply and control circuit							
	Cu cable - Stranded 1 x mm <sup>2</sup>				0.75...2.5 mm <sup>2</sup> (19...14 AWG)		
	Cu cable - Stranded 2 x mm <sup>2</sup>				0.75...1.5 mm <sup>2</sup> (19...16 AWG)		
	Tightening torque				0.5 Nm (4.4 in lb)		

<sup>1)</sup> Terminal shrouds 1SFN125406R1000 must be used.

<sup>2)</sup> Terminal shrouds 1SFN125406R1000 can be used.

# PSTX - The advanced range

## Dimensions

Main dimensions mm, inches

PSTX30 ... PSTX105

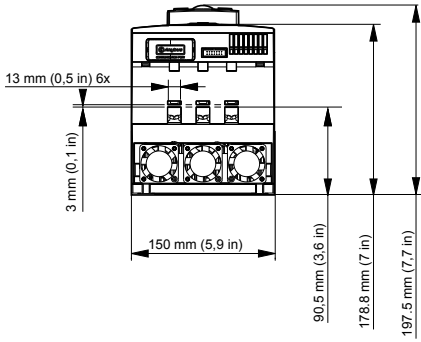

PSTX142 ... PSTX170

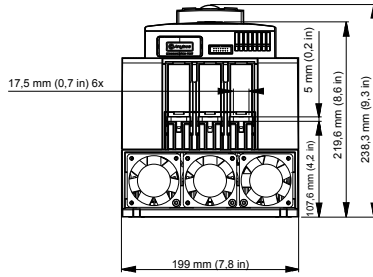

PSTX210 ... PSTX370

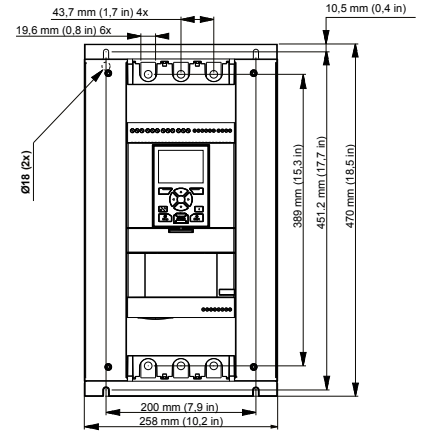
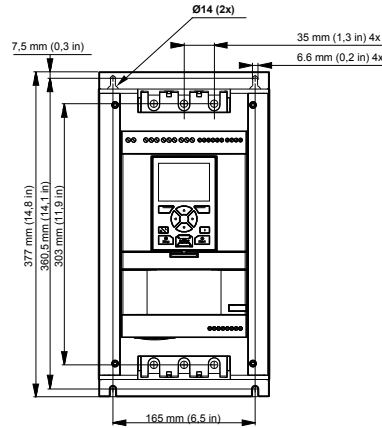
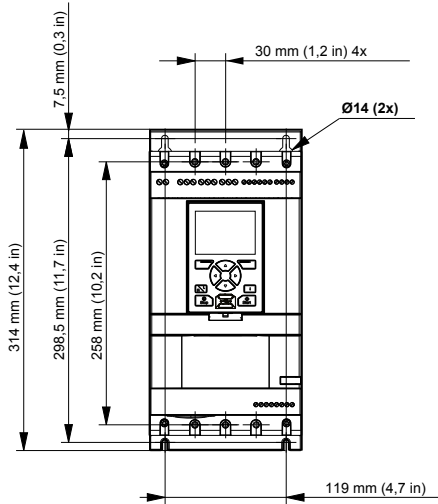
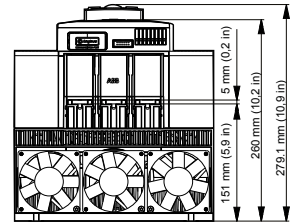

PSTX detachable keypad

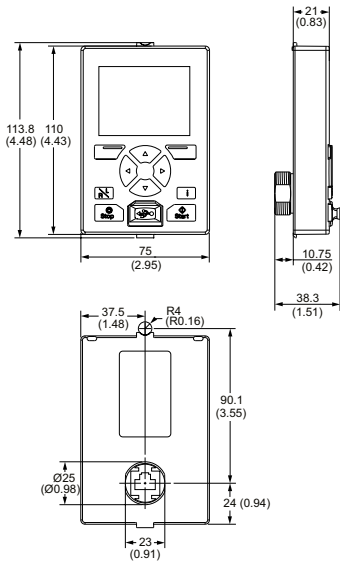

# PSTX - The advanced range

## Dimensions

Main dimensions mm, inches

PSTX470 ... PSTX570

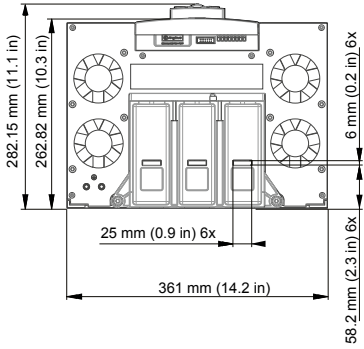

PSTX720 ... PSTX840

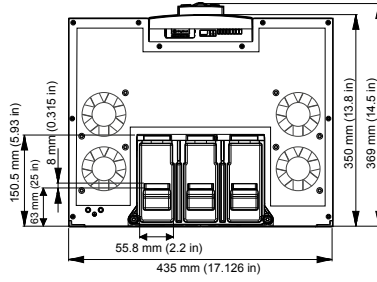

PSTX1050

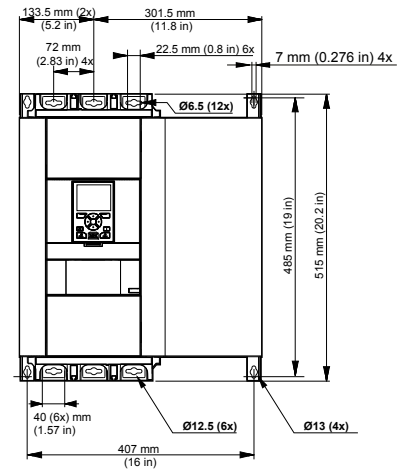
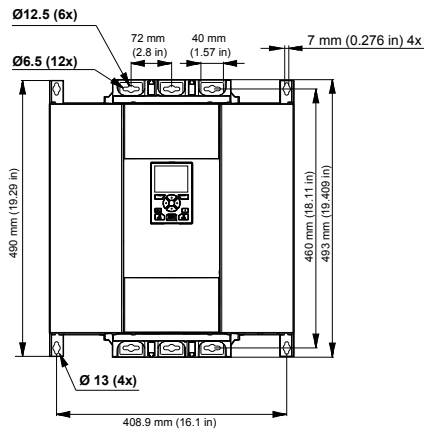
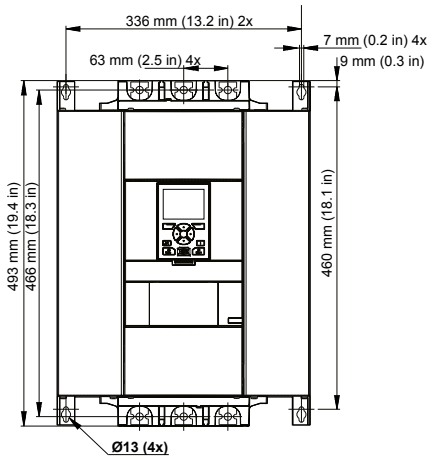
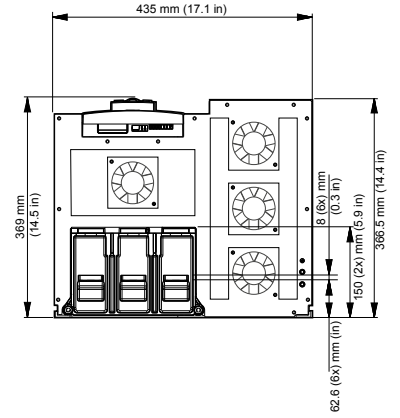

PSTX1250

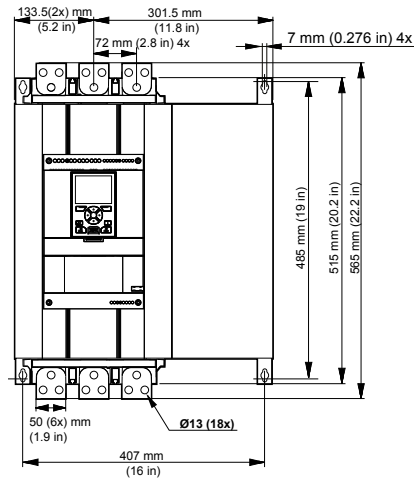
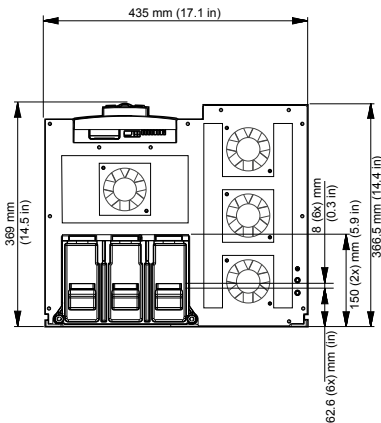

# PSTX - The advanced range

## Circuit diagrams



### CAUTION

Terminal 22 is a function earth, it is not a protective earth. It shall be connected to the mounting plate.

### PSTX30 ... PSTX1250

#### IEC circuit diagram

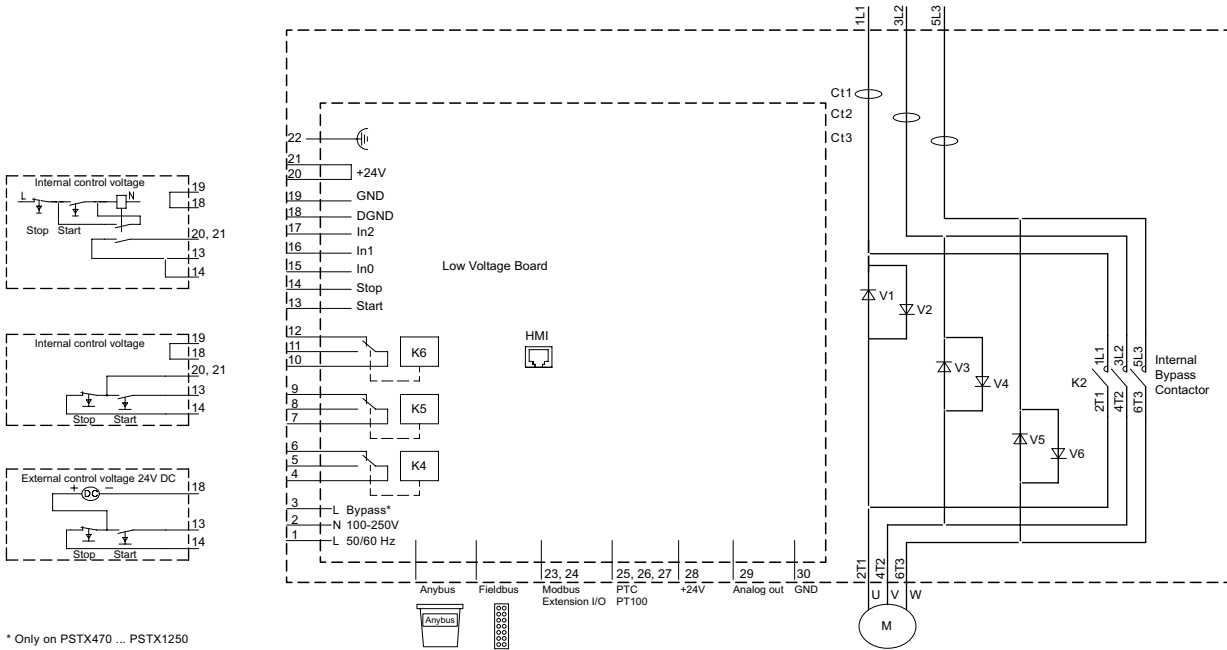

\* Only on PSTX470 ... PSTX1250

### UL circuit diagram

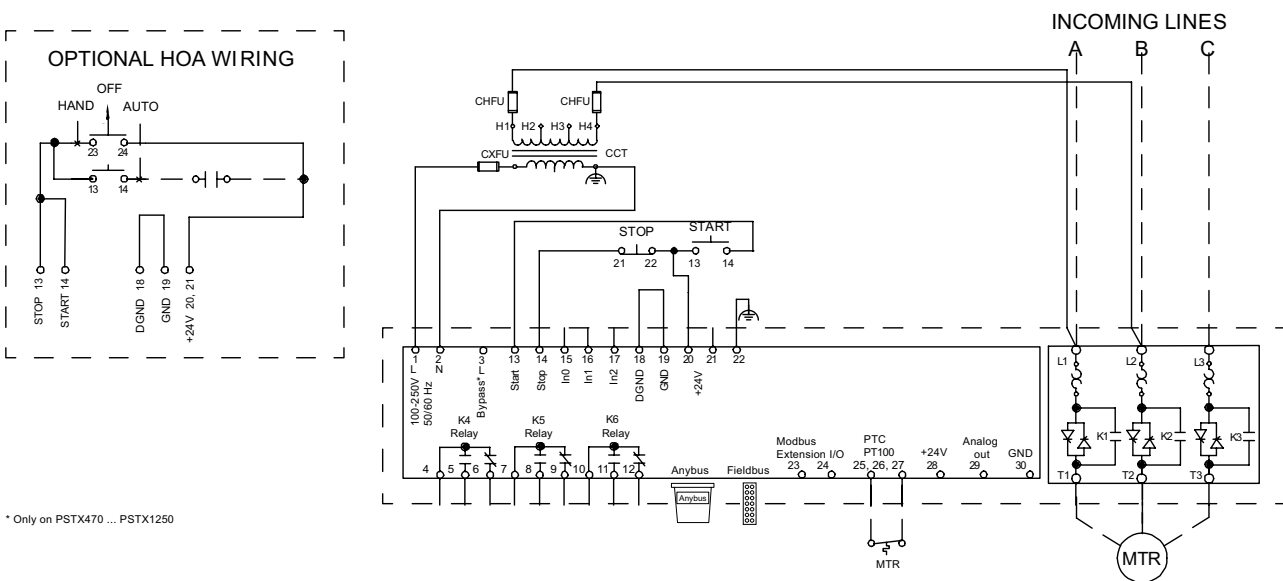

\* Only on PSTX470 ... PSTX1250

For more circuit diagrams see [new.abb.com/low-voltage/products/softstarters](http://new.abb.com/low-voltage/products/softstarters)

# PSTX - The advanced range

## Circuit diagrams

### PSTX30 ... PSTX1250

#### In-line connected with line contactor and fuses

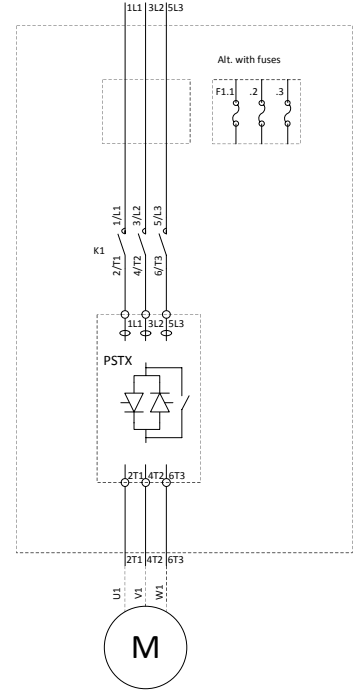
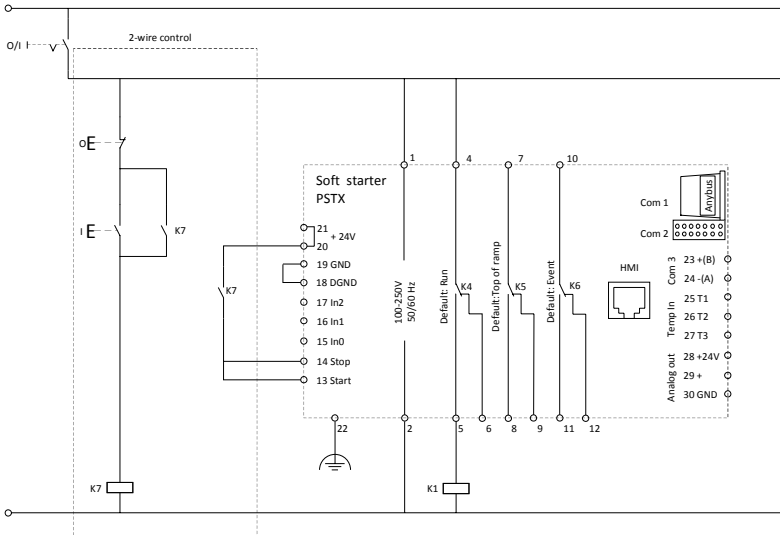

Coil consumption for main contactors.  
 Pull-in max 15A  
 Holding max 1.5A

If the pull-in or holding values are higher, the main contactors must be controlled via an auxiliary contactor.

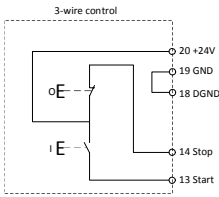

#### Inside-delta connected with contactor and fuses

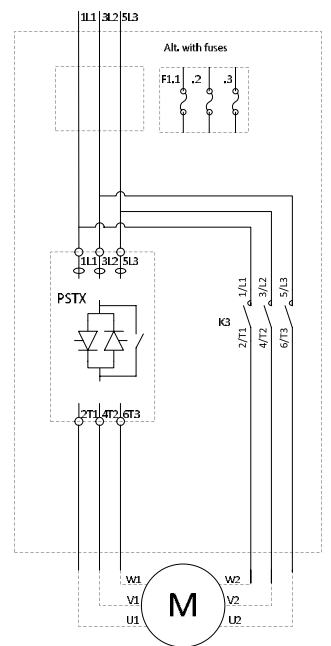
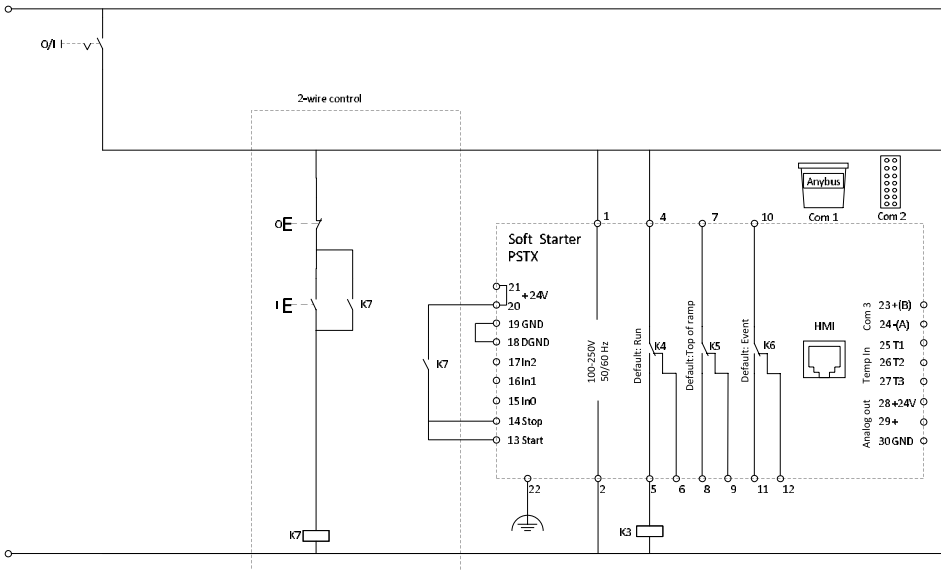

Coil consumption for Inside Delta contactor.  
 Pull-in max 15A  
 Holding max 1,5A

If the pull-in or holding values are Higher, the Inside Delta contactor must be controlled via an auxiliary contactor.

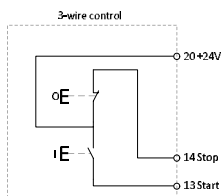



---

# Fieldbus communication

<b>60</b>	<b>Introduction</b>
<b>61</b>	<b>Anybus ordering details</b>
<b>63–63</b>	<b>Fieldbusplug ordering details</b>
<b>64–65</b>	<b>Fieldbusplug accessories ordering details</b>

# Fieldbus communication



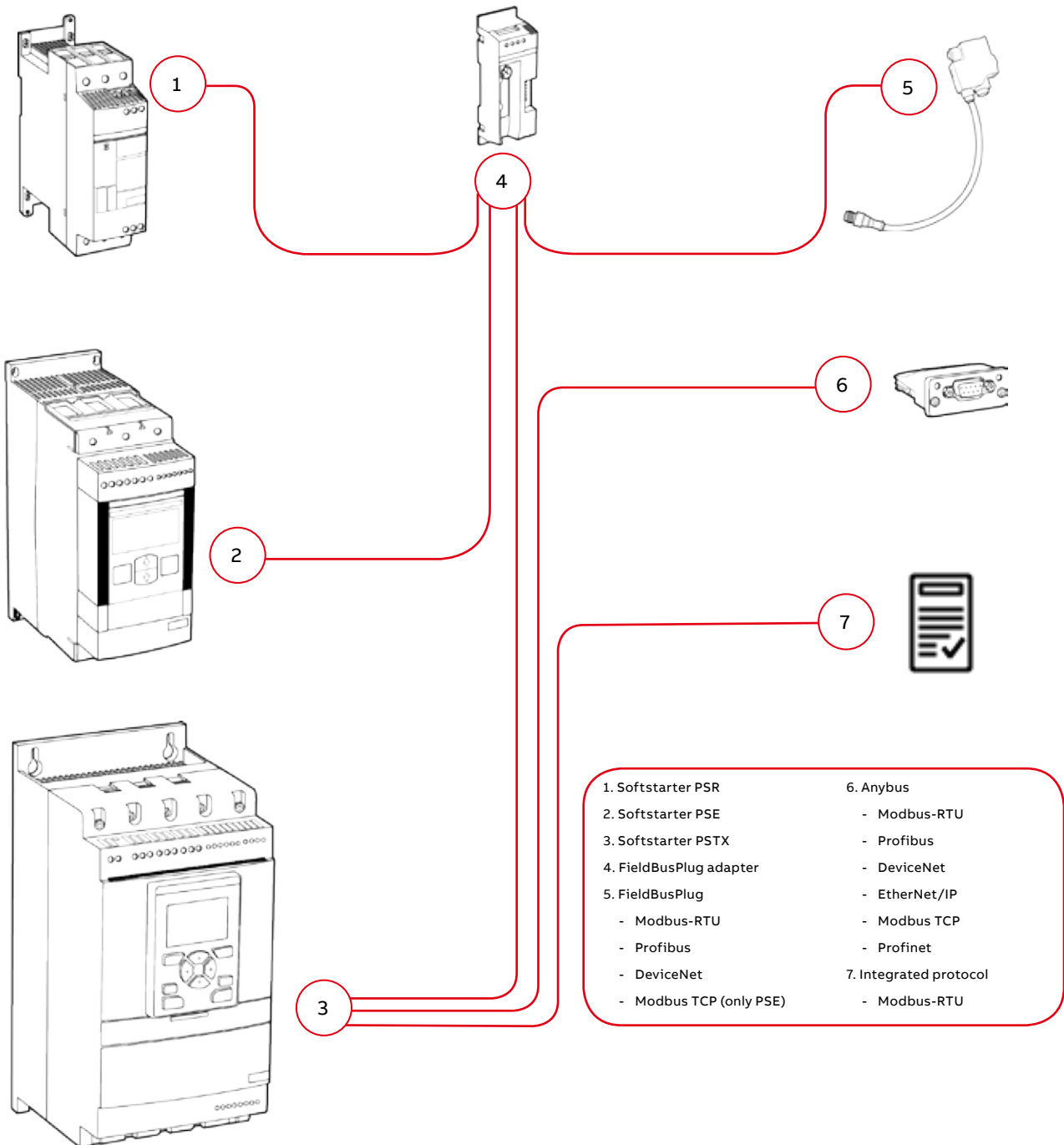

## Introduction

PSR, PSE and PSTX softstarters can be connected to a fieldbus network for monitoring and control. All major industrial fieldbus protocols are covered with different accessories making the installation very flexible.



## Fieldbus communication

### Anybus ordering details

	For communication protocol	Type	Order code	Pkg qty	Weight (1 pce) kg	(lb)
 <b>Profibus Modbus-RTU</b> <small>1SFC132120V0001</small>	Profibus	AB-PROFIBUS-1	1SFA899300R1001	1	0.042	(0.093)
	DeviceNet	AB-DEVICENET-1	1SFA899300R1002	1	0.042	(0.093)
 <b>EtherNet/IP (1-port) Modbus TCP (1-port)</b> <small>1SFC132118V0001</small>	Modbus-RTU	AB-MODBUS-RTU-1	1SFA899300R1003	1	0.042	(0.093)
	EtherNet/IP (1-port)	AB-ETHERNET-IP-1	1SFA899300R1005	1	0.042	(0.093)
	EtherNet/IP (2-port)	AB-ETHERNET-IP-2	1SFA899300R1006	1	0.042	(0.093)
	Modbus TCP (1-port)	AB-MODBUS-TCP-1	1SFA899300R1007	1	0.042	(0.093)
	Modbus TCP (2-port)	AB-MODBUS-TCP-2	1SFA899300R1008	1	0.042	(0.093)
	Profinet (2-port)	AB-PROFINET-IO-2	1SFA899300R1010	1	0.042	(0.093)
 <b>DeviceNet</b> <small>1SFC132121V0001</small>						
 <b>EtherNet/IP (2-port) Modbus TCP (2-port) Profinet (2-port)</b> <small>1SFC132119V0001</small>						

## Fieldbus communication

### Fieldbusplug ordering details

Black cable



**DeviceNet FieldBusPlug**

- Ready-made DeviceNet fieldbus interface with various cable lengths
- Applicable on all FBP motor starters and other devices
- Degree of protection IP65, diagnostic LED

Designation	Cable length	Type	Order code	Pkg qty	Weight (1 pce)	
					kg	(lb)
DeviceNet-FBP	0.25 m	DNP21-FBP.025	1SAJ230000R1003	1	0.09	(0.20)
DeviceNet-FBP	0.50 m	DNP21-FBP.050	1SAJ230000R1005	1	0.10	(0.22)
DeviceNet-FBP	1.00 m	DNP21-FBP.100	1SAJ230000R1010	1	0.13	(0.29)
DeviceNet-FBP	5.00 m	DNP21-FBP.500	1SAJ230000R1050	1	0.36	(0.79)

DNP21-FBP  
MRP21-FBP  
COP21-FBP



**Modbus-RTU FieldBusPlug**

- Ready-made Modbus-RTU fieldbus interface with various cable lengths
- Applicable on all FBP motor starters and other devices
- Degree of protection IP65, diagnostic LED

Designation	Cable length	Type	Order code	Pkg qty	Weight (1 pce)	
					kg	(lb)
MODBUS-RTU-FBP	0.25 m	MRP21-FBP.025	1SAJ250000R0003	1	0.09	(0.20)
MODBUS-RTU-FBP	0.50 m	MRP21-FBP.050	1SAJ250000R0005	1	0.10	(0.22)
MODBUS-RTU-FBP	1.00 m	MRP21-FBP.100	1SAJ250000R0010	1	0.13	(0.29)
MODBUS-RTU-FBP	5.00 m	MRP21-FBP.500	1SAJ250000R0050	1	0.36	(0.79)

DNP21-FBP  
MRP21-FBP  
COP21-FBP



**Ethernet Modbus TCP interface MTQ22-FBP**

- Ethernet connectivity for up to four units
- Modbus TCP protocol
- Supports all network topologies
- No special Ethernet connectors required in MCCs
- Easy to use in withdrawable applications

Designation	Cable length	Type	Order code	Pkg qty	Weight (1 pce)	
					kg	(lb)
Ethernet Modbus TCP interface		MTQ22-FBP	1SAJ260000R0100	1	0.20	(0.44)
Cable MTQ to FieldBusPlug adapter	1.5 m	CDP17-FBP.150	1SAJ929170R0015	1	0.01	(0.02)
Passive cable fixing bracket		CDP11-FBP.4	1SAJ929100R0004	4	0.01	(0.02)

MTQ22-FBP

**To connect the softstarter to a DeviceNet fieldbus system...**  
 you need specific software for PLC setup, (EDS file) which is available at [new.abb.com/low-voltage/products/softstarters](http://new.abb.com/low-voltage/products/softstarters)  
 If you need help or advice, please contact your local ABB office.

## Fieldbus communication

Fieldbusplug ordering details

Purple cable



PDP22-FBP

### Profibus DP FieldBusPlug

- Ready-made Profibus DP fieldbus interface with various cable lengths.
- Supports PROFIBUS DP V0 and V1
- Applicable on all FBP motor starters and other devices
- Degree of protection IP65, diagnostic LED

Designation	Cable length	Type	Order code	Pkg qty	Weight (1 pce)	
					kg	(lb)
Profibus DP FBP	0.25 m	PDP22-FBP.025	1SAJ240100R1003	1	0.09	(0.20)
Profibus DP FBP	0.50 m	PDP22-FBP.050	1SAJ240100R1005	1	0.10	(0.22)
Profibus DP FBP	1.00 m	PDP22-FBP.100	1SAJ240100R1010	1	0.13	(0.29)
Profibus DP FBP	2.00 m	PDP22-FBP.200	1SAJ240100R1020	1	0.20	(0.44)
Profibus DP FBP	5.00 m	PDP22-FBP.500	1SAJ240100R1050	1	0.36	(0.79)

### Profibus DP FieldBusPlug for four devices

- PDQ22 is a member of the ABB's FieldBusPlug family of bus connectors. It allows the connection of up to four devices to Profibus DP by just using one Profibus node access. This allows a cost efficient device integration for devices that are located physically nearby. PDQ22 supports DP-V0 and DP-V1. The degree of protection is IP66. There are separate diagnosis LEDs for bus and device status.

**Note that the accessory PDQ22-FBP only works with the PSR and PSE softstarter.**

Designation	Type	Order code	Pkg qty	Weight (1 pce)	
				kg	(lb)
Quadruple bus connector	PDQ22-FBP	1SAJ240200R0050	1	0.20	(0.44)
DINrail adapter for PDQ22-FBP	CDA11-FBP.0	1SAJ929300R0001	1	0.11	(0.24)
Fixing bracket for passive plug of connection cable	CDP11-FBP.0	1SAJ929100R0001	1	0.50	(1.10)



PDQ22-FBP







2CDC341048F0006

**To connect the softstarter to a DeviceNet fieldbus system...**  
 you need specific software for PLC setup, (EDS file) which is available at [new.abb.com/low-voltage/products/softstarters](http://new.abb.com/low-voltage/products/softstarters)  
 If you need help or advice, please contact your local ABB office.

## Fieldbus communication

Fieldbusplug accessories ordering details

Black cable

Accessories for the DeviceNet and Modbus-RTU bus connector						
 DNF11-FBP.050	DeviceNet and Modbus-RTU round cable for bus junctions Ready-made bus cable with an M12 connector and an open cable end					
	Designation	Cable length	Type	Order code	Pkg qty	Weight (1 pce)
 DNM11-FBP.050	Round cable with female connector	0.50 m	DNF11-FBP.050	1SAJ923002R0005	1	0.04 (0.09)
	Round cable with male connector	0.50 m	DNM11-FBP.050	1SAJ923003R0005	1	0.04 (0.09)
Devicenet and Modbus-RTU round cable for bus extension						
 DNX11-FDP	Ready-made bus cable with M12 male and female connectors					
	Designation	Cable length	Type	Order code	Pkg qty	Weight (1 pce)
	Extension cable	1.00 m	DNX11-FBP.100	1SAJ923001R0010	1	0.08 (0.18)
	Extension cable	3.00 m	DNX11-FBP.300	1SAJ923001R0030	1	0.20 (0.44)
	Extension cable	5.00 m	DNX11-FBP.500	1SAJ923001R0050	1	0.31 (0.68)
Round cable	100.00 m	DNC11-FBP.999	1SAJ923004R0001	1	5.60 (12.35)	
DeviceNet and Modbus-RTU round cable connectors						
 DNM11-FBP.0	Bus cable and coupling accessories					
	Designation	Type	Order code	Pkg qty	Weight (1 pce)	
	Male connector for round cable	DNM11-FBP.0	1SAJ923005R0001	5	0.15 (0.33)	
 DNF11-FBP.0	Female connector for round cable					
	Female connector for round cable	DNF11-FBP.0	1SAJ923006R0001	5	0.15 (0.33)	
DeviceNet and Modbus-RTU termination resistor						
 DNR11-FBP.120	Termination Resistor, 120 Ohm					
	Designation	Type	Order code	Pkg qty	Weight (1 pce)	
	Termination Resistor, 120 Ohm	DNR11-FBP.120	1SAJ923007R0001	1	0.02 (0.04)	

## Fieldbus communication

### Fieldbusplug accessories ordering details

#### Purple cable

		<b>Accessories for the Profibus DP Bus Connector</b>																																										
 PDF11-FBP.50  PDM11-FBP.50	ST05301LLA2 ST02201llnc1	Profibus DP Round cable for Bus Junctions Ready-made bus cable with an M12 connector and an open cable end. Application on bus junctions such as e.g. Profibus DB couplers or devices with an integrated Profibus DB interface																																										
		<table border="1"> <thead> <tr> <th rowspan="2">Designation</th> <th rowspan="2">Cable length</th> <th rowspan="2">Type</th> <th rowspan="2">Order code</th> <th colspan="2">Pkg Weight qty (1 pce)</th> </tr> <tr> <th>kg</th> <th>(lb)</th> </tr> </thead> <tbody> <tr> <td>Round cable with female connector</td> <td>0.50 m</td> <td>PDF11-FBP.050</td> <td>1SAJ924002R0005</td> <td>1</td> <td>0.04 (0.09)</td> </tr> <tr> <td>Round cable with male connector</td> <td>0.50 m</td> <td>PDM11-FBP.050</td> <td>1SAJ924003R0005</td> <td>1</td> <td>0.04 (0.09)</td> </tr> </tbody> </table>	Designation	Cable length	Type	Order code	Pkg Weight qty (1 pce)		kg	(lb)	Round cable with female connector	0.50 m	PDF11-FBP.050	1SAJ924002R0005	1	0.04 (0.09)	Round cable with male connector	0.50 m	PDM11-FBP.050	1SAJ924003R0005	1	0.04 (0.09)																						
Designation	Cable length	Type					Order code	Pkg Weight qty (1 pce)																																				
			kg	(lb)																																								
Round cable with female connector	0.50 m	PDF11-FBP.050	1SAJ924002R0005	1	0.04 (0.09)																																							
Round cable with male connector	0.50 m	PDM11-FBP.050	1SAJ924003R0005	1	0.04 (0.09)																																							
		<b>Profibus DP round cable for bus extension</b>																																										
		Ready-made bus cable with M12 male and female connectors Round cable on coil																																										
 PDX11-FBP	ST04801LLA2C	<table border="1"> <thead> <tr> <th rowspan="2">Designation</th> <th rowspan="2">Cable length</th> <th rowspan="2">Type</th> <th rowspan="2">Order code</th> <th colspan="2">Pkg Weight qty (1 pce)</th> </tr> <tr> <th>kg</th> <th>(lb)</th> </tr> </thead> <tbody> <tr> <td>Extension cable</td> <td>0.50 m</td> <td>PDX11-FBP.050</td> <td>1SAJ924001R0005</td> <td>1</td> <td>0.04 (0.09)</td> </tr> <tr> <td>Extension cable</td> <td>1.00 m</td> <td>PDX11-FBP.100</td> <td>1SAJ924001R0010</td> <td>1</td> <td>0.08 (0.18)</td> </tr> <tr> <td>Extension cable</td> <td>3.00 m</td> <td>PDX11-FBP.300</td> <td>1SAJ924001R0030</td> <td>1</td> <td>0.20 (0.44)</td> </tr> <tr> <td>Extension cable</td> <td>5.00 m</td> <td>PDX11-FBP.500</td> <td>1SAJ924001R0050</td> <td>1</td> <td>0.31 (0.68)</td> </tr> <tr> <td>Round cable</td> <td>100.00 m</td> <td>PDC11-FBP.999</td> <td>1SAJ924004R1000</td> <td>1</td> <td>5.60 (12.35)</td> </tr> </tbody> </table>					Designation	Cable length	Type	Order code	Pkg Weight qty (1 pce)		kg	(lb)	Extension cable	0.50 m	PDX11-FBP.050	1SAJ924001R0005	1	0.04 (0.09)	Extension cable	1.00 m	PDX11-FBP.100	1SAJ924001R0010	1	0.08 (0.18)	Extension cable	3.00 m	PDX11-FBP.300	1SAJ924001R0030	1	0.20 (0.44)	Extension cable	5.00 m	PDX11-FBP.500	1SAJ924001R0050	1	0.31 (0.68)	Round cable	100.00 m	PDC11-FBP.999	1SAJ924004R1000	1	5.60 (12.35)
	Designation	Cable length	Type	Order code	Pkg Weight qty (1 pce)																																							
					kg	(lb)																																						
	Extension cable	0.50 m	PDX11-FBP.050	1SAJ924001R0005	1	0.04 (0.09)																																						
	Extension cable	1.00 m	PDX11-FBP.100	1SAJ924001R0010	1	0.08 (0.18)																																						
	Extension cable	3.00 m	PDX11-FBP.300	1SAJ924001R0030	1	0.20 (0.44)																																						
Extension cable	5.00 m	PDX11-FBP.500	1SAJ924001R0050	1	0.31 (0.68)																																							
Round cable	100.00 m	PDC11-FBP.999	1SAJ924004R1000	1	5.60 (12.35)																																							
		<b>Profibus DP accessories for bus extension</b>																																										
 PDM11-FBP  PDF11-FBP	2CDC341051F0003 2CDC340950F0003	<table border="1"> <thead> <tr> <th rowspan="2">Designation</th> <th rowspan="2">Type</th> <th rowspan="2">Order code</th> <th colspan="2">Pkg Weight qty (1 pce)</th> </tr> <tr> <th>kg</th> <th>(lb)</th> </tr> </thead> <tbody> <tr> <td>Male Connector for round cable</td> <td>PDM11-FBP.0</td> <td>1SAJ924005R0001</td> <td>5</td> <td>0.03 (0.07)</td> </tr> <tr> <td>Female Connector for round cable</td> <td>PDF11-FBP.0</td> <td>1SAJ924006R0001</td> <td>5</td> <td>0.03 (0.07)</td> </tr> </tbody> </table>					Designation	Type	Order code	Pkg Weight qty (1 pce)		kg	(lb)	Male Connector for round cable	PDM11-FBP.0	1SAJ924005R0001	5	0.03 (0.07)	Female Connector for round cable	PDF11-FBP.0	1SAJ924006R0001	5	0.03 (0.07)																					
	Designation	Type	Order code	Pkg Weight qty (1 pce)																																								
kg				(lb)																																								
Male Connector for round cable	PDM11-FBP.0	1SAJ924005R0001	5	0.03 (0.07)																																								
Female Connector for round cable	PDF11-FBP.0	1SAJ924006R0001	5	0.03 (0.07)																																								
		<b>Profibus DP termination resistor, miscellaneous accessories</b>																																										
 PDR11-FBP.150  PDV11-FBP, PDV12-FBP	2CDC341054F0003 2CDC341053F0003	<table border="1"> <thead> <tr> <th rowspan="2">Designation</th> <th rowspan="2">Type</th> <th rowspan="2">Order code</th> <th colspan="2">Pkg Weight qty (1 pce)</th> </tr> <tr> <th>kg</th> <th>(lb)</th> </tr> </thead> <tbody> <tr> <td>Termination resistor, 150 Ohm</td> <td>PDR11-FBP.150</td> <td>1SAJ924007R0001</td> <td>1</td> <td>0.03 (0.07)</td> </tr> <tr> <td>Feeding connector 24V DC, Code B-A</td> <td>PDV11-FBP.0</td> <td>1SAJ924008R0001</td> <td>1</td> <td>0.04 (0.09)</td> </tr> <tr> <td>Feeding connector 24V DC, Code A-A</td> <td>PDV12-FBP.0</td> <td>1SAJ924011R0001</td> <td>1</td> <td>0.04 (0.09)</td> </tr> <tr> <td>Adaptor M12-Dsub9-M12 Cable length 0.50m</td> <td>PDA11-FBP.050</td> <td>1SAJ924009R0001</td> <td>1</td> <td>0.04 (0.09)</td> </tr> <tr> <td>Adaptor M12-Dsub9-M12 Cable length 2 x 0.50m</td> <td>PDA12-FBP.050</td> <td>1SAJ924010R0001</td> <td>1</td> <td>0.04 (0.09)</td> </tr> </tbody> </table>					Designation	Type	Order code	Pkg Weight qty (1 pce)		kg	(lb)	Termination resistor, 150 Ohm	PDR11-FBP.150	1SAJ924007R0001	1	0.03 (0.07)	Feeding connector 24V DC, Code B-A	PDV11-FBP.0	1SAJ924008R0001	1	0.04 (0.09)	Feeding connector 24V DC, Code A-A	PDV12-FBP.0	1SAJ924011R0001	1	0.04 (0.09)	Adaptor M12-Dsub9-M12 Cable length 0.50m	PDA11-FBP.050	1SAJ924009R0001	1	0.04 (0.09)	Adaptor M12-Dsub9-M12 Cable length 2 x 0.50m	PDA12-FBP.050	1SAJ924010R0001	1	0.04 (0.09)						
	Designation	Type	Order code	Pkg Weight qty (1 pce)																																								
				kg	(lb)																																							
	Termination resistor, 150 Ohm	PDR11-FBP.150	1SAJ924007R0001	1	0.03 (0.07)																																							
	Feeding connector 24V DC, Code B-A	PDV11-FBP.0	1SAJ924008R0001	1	0.04 (0.09)																																							
	Feeding connector 24V DC, Code A-A	PDV12-FBP.0	1SAJ924011R0001	1	0.04 (0.09)																																							
Adaptor M12-Dsub9-M12 Cable length 0.50m	PDA11-FBP.050	1SAJ924009R0001	1	0.04 (0.09)																																								
Adaptor M12-Dsub9-M12 Cable length 2 x 0.50m	PDA12-FBP.050	1SAJ924010R0001	1	0.04 (0.09)																																								
		<b>Extension cable</b>																																										
 PDA11-FBP.050  PDA12-FBP.050	2CDC341006F0004 2CDC341007F0004	<table border="1"> <thead> <tr> <th rowspan="2">Designation</th> <th rowspan="2">Cable length</th> <th rowspan="2">Type</th> <th rowspan="2">Order code</th> <th colspan="2">Pkg Weight qty (1 pce)</th> </tr> <tr> <th>kg</th> <th>(lb)</th> </tr> </thead> <tbody> <tr> <td>Extension cable (female/male), shielded</td> <td>0.3 m</td> <td>CDP15-FBP.030</td> <td>1SAJ929140R0003</td> <td>1</td> <td>0.01 (0.02)</td> </tr> <tr> <td>Extension cable (female/male), shielded</td> <td>0.6 m</td> <td>CDP15-FBP.060</td> <td>1SAJ929140R0006</td> <td>1</td> <td>0.01 (0.02)</td> </tr> <tr> <td>Extension cable (female/male), shielded</td> <td>1.5 m</td> <td>CDP15-FBP.150</td> <td>1SAJ929140R0015</td> <td>1</td> <td>0.20 (0.44)</td> </tr> <tr> <td>Extension cable (male/open), shielded</td> <td>1.5 m</td> <td>CDP16-FBP.150</td> <td>1SAJ929150R0015</td> <td>1</td> <td>0.20 (0.44)</td> </tr> </tbody> </table>					Designation	Cable length	Type	Order code	Pkg Weight qty (1 pce)		kg	(lb)	Extension cable (female/male), shielded	0.3 m	CDP15-FBP.030	1SAJ929140R0003	1	0.01 (0.02)	Extension cable (female/male), shielded	0.6 m	CDP15-FBP.060	1SAJ929140R0006	1	0.01 (0.02)	Extension cable (female/male), shielded	1.5 m	CDP15-FBP.150	1SAJ929140R0015	1	0.20 (0.44)	Extension cable (male/open), shielded	1.5 m	CDP16-FBP.150	1SAJ929150R0015	1	0.20 (0.44)						
	Designation	Cable length	Type	Order code	Pkg Weight qty (1 pce)																																							
					kg	(lb)																																						
	Extension cable (female/male), shielded	0.3 m	CDP15-FBP.030	1SAJ929140R0003	1	0.01 (0.02)																																						
	Extension cable (female/male), shielded	0.6 m	CDP15-FBP.060	1SAJ929140R0006	1	0.01 (0.02)																																						
Extension cable (female/male), shielded	1.5 m	CDP15-FBP.150	1SAJ929140R0015	1	0.20 (0.44)																																							
Extension cable (male/open), shielded	1.5 m	CDP16-FBP.150	1SAJ929150R0015	1	0.20 (0.44)																																							

# Marketing materials and tools

It is easy to access more information about ABB's softstarters online. On our web page you will find tools for selection, coordination tables, CAD drawings and different types of documentation.

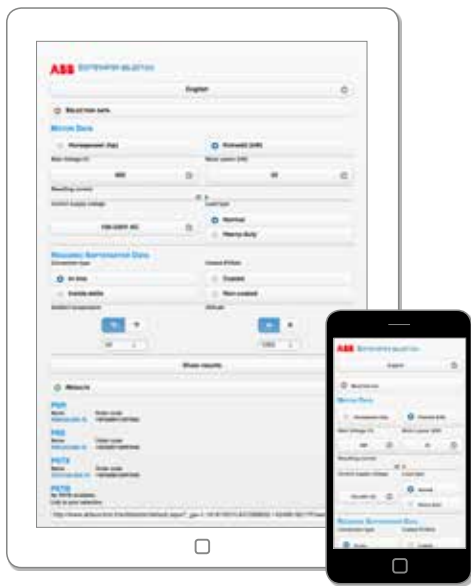

Online softstarter selection tool  
Fast and easy selection of softstarter on any device.



[www.abbcontrol.fr/softstarter](http://www.abbcontrol.fr/softstarter)

## Coordination tables

Online tool for coordination with short circuit protection, overload protection and line contactor.



[applications.it.abb.com/SOC](http://applications.it.abb.com/SOC)

SOC - Selected Optimized Coordination tables for motor protection

Motor	Short circuit	Motor thermal capacity	Coordination
M001	1000 A	1000 A	1000 A
M002	1000 A	1000 A	1000 A
M003	1000 A	1000 A	1000 A
M004	1000 A	1000 A	1000 A
M005	1000 A	1000 A	1000 A
M006	1000 A	1000 A	1000 A
M007	1000 A	1000 A	1000 A
M008	1000 A	1000 A	1000 A
M009	1000 A	1000 A	1000 A
M010	1000 A	1000 A	1000 A
M011	1000 A	1000 A	1000 A
M012	1000 A	1000 A	1000 A
M013	1000 A	1000 A	1000 A
M014	1000 A	1000 A	1000 A
M015	1000 A	1000 A	1000 A
M016	1000 A	1000 A	1000 A
M017	1000 A	1000 A	1000 A
M018	1000 A	1000 A	1000 A
M019	1000 A	1000 A	1000 A
M020	1000 A	1000 A	1000 A



—

**ABB AB**

Control Products

Low Voltage Products

SE-721 61 VÄSTERÅS, Sweden

[www.abb.com/lowvoltage](http://www.abb.com/lowvoltage)

[www.abb.com/connecttocontrol](http://www.abb.com/connecttocontrol)



To get more information,  
install QR code reader on  
your mobile device, scan the  
code and see more.