

1625020001

ZPL CL.04 WING NT LIGHT (AM) M20

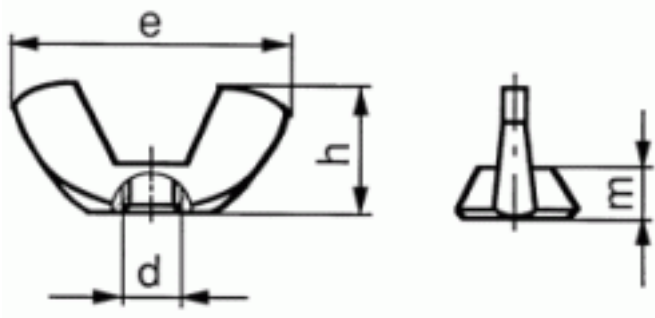

Brand	-
UBB Code	950355163193
UNSPSC Code	31161717
EAN Code	8715492590381
Thread	Metric thread
Class	04
Material	Steel
Surface treatment	Zinc plated
Driving features	wing



h ≈	31,2
e ≈	66,5
m ≈	12,2
P	2,5
d	M20
Packaging (Piece )	10.0



Copyright Fabory Group