

5181010001

STNL A2 WING NT LIGHT (AM) M10

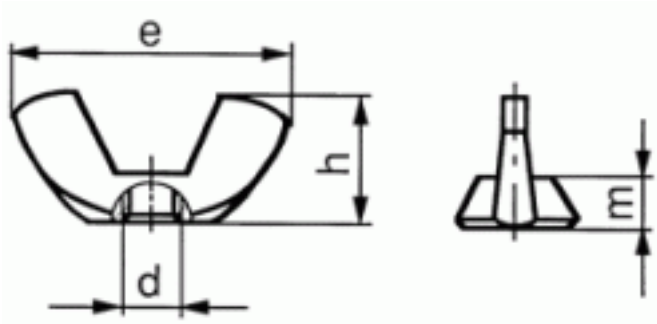

Brand	-
UBB Code	950355229788
UNSPSC Code	31161717
EAN Code	8715492310538
Driving features	wing
Thread	Metric thread
Material	Stainless steel
Material technical	A2



h ≈	17,3
e ≈	35,3
m ≈	6,3
P	1,5
d	M10
Packaging (Piece )	25.0



Copyright Fabory Group