

04120180001

D934 |10| HX NT M18

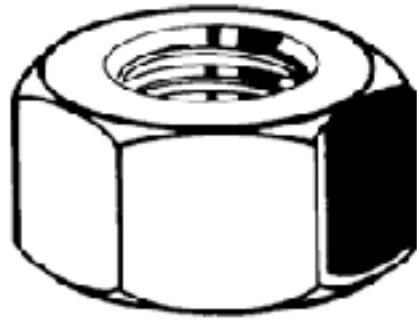

Brand	-
UBB Code	950355043155
UNSPSC Code	31161727
EAN Code	8715492119544
Driving features	hexagon
Material	Steel
Class	10
Thread	Metric thread

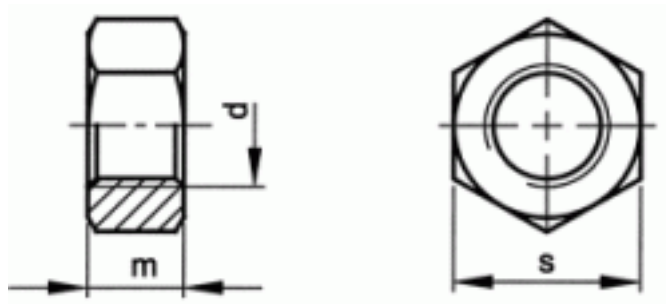

s	27
m	15
P	2,5
d	M18
Packaging (Piece)	50.0



Copyright Fabory Group