

Nella

THORN

96636345 NELLA 3000-730 R-S CL2 T60 ANT

LED 30W Nella_R-S	ISO 9223 C3	IP66	IK08		CE				Ta-20 +50
-------------------	----------------	------	------	--	----	--	--	--	--------------

Nella

A contemporary design respectful of the environment with zero upward lighting and rotational symmetrical light distribution. Class II electrical, IP66, IK08. Base in Die-cast aluminium, powder coated anthracite. Enclosure: tempered glass. Simplified control with a switch button to adapt the lumen output. Supplied complete in one box. Complete with 3000K LED

To be post top mounted on a spigot of Ø60mm, length 65mm at a recommended height of 3 to 4,5m. Pre-wired with 4 meter cable for ease of installation

Dimensions: Ø78/400 x 509 mm
Total luminous flux: 3642 lm
Luminaire input power: 29.5 W
Weight: 10 kg
Scx : 0.11m²



TLG_NELLA_F_1.jpg

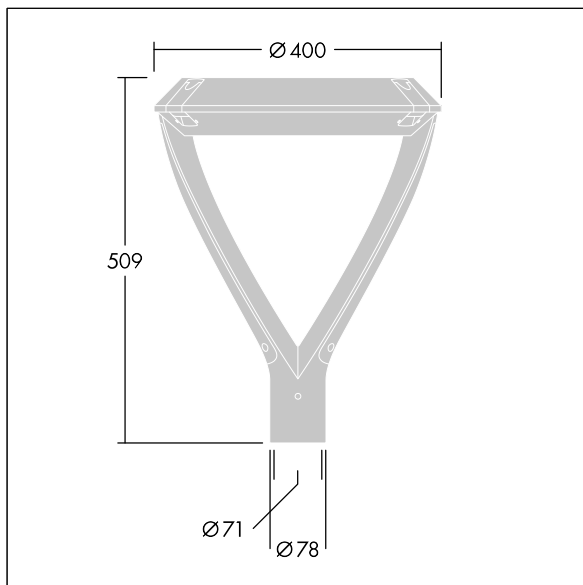

TLG_NELLA_M_Front.wmf

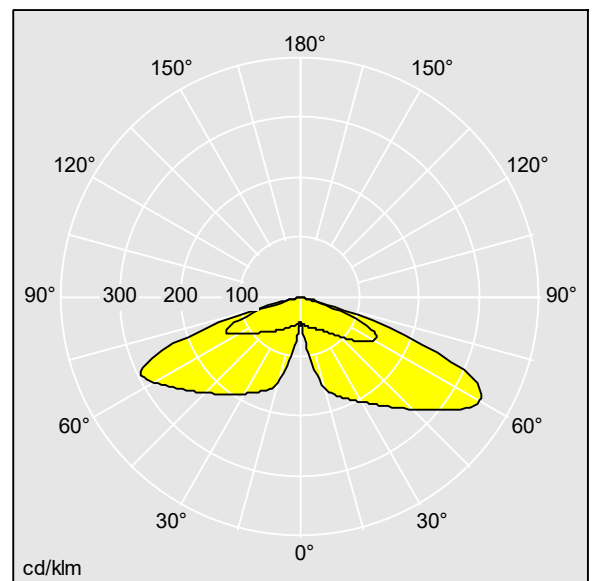

TLG_96636345_NELLA3000-730R-S_CL2_T60_ANT.ltd

Lamp position: STD - standard
Light Source: LED
Luminaire luminous flux*: 3646 lm
Luminaire efficacy*: 124 lm/W
Colour Rendering Index min.: 70
LOR: 1,00 ULOR: 0,01 DLOR: 0,99

Correlated colour temperature*: 3000 Kelvin
Chromaticity tolerance (initial MacAdam): 5
Ballast: 1x LED_Con
Luminaire input power*: 29.5 W Power factor = 0.95
Dimming: FO

This product contains a light source of energy efficiency class C.

All values marked with an * are rated values. Thorn uses tried and tested components from leading suppliers, however there may be isolated instances of technology-related failures of individual LEDs during the rated product lifetime. International standards set the tolerance in initial flux and connected load at ±10%. Unless stated otherwise, the values apply to an ambient temperature of 25°C. Risk group

Thorn Lighting is constantly developing and improving its products. The right is reserved to change specifications without prior notification or public announcement.
© Thorn Lighting

96636345 NELLA 3000-730 R-S CL2 T60 ANT

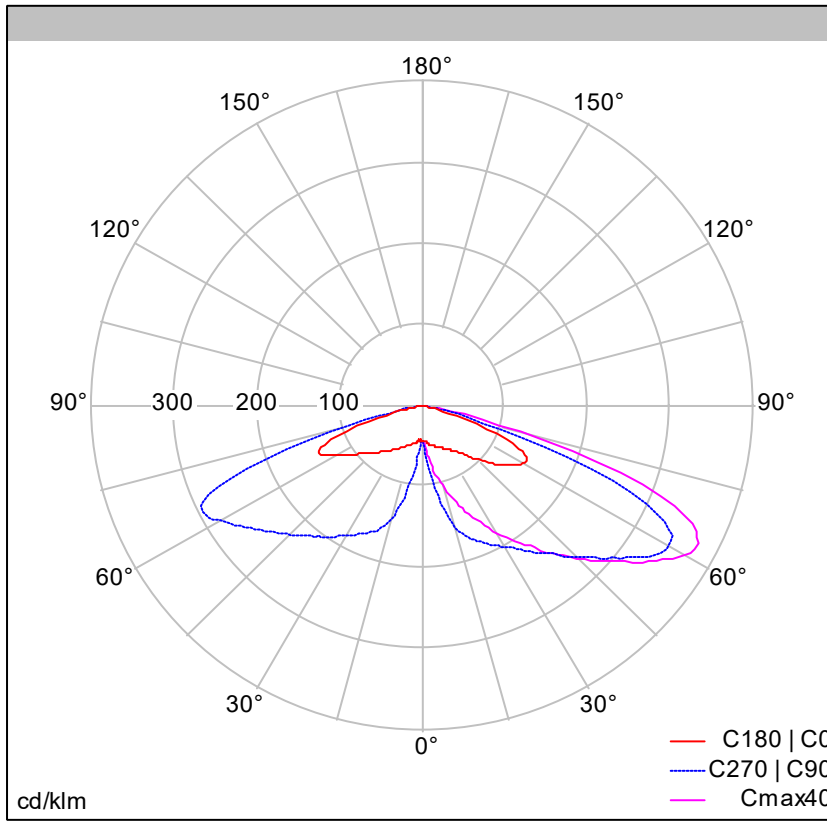

Lamps 1 x /
Lamp adjustment
IP

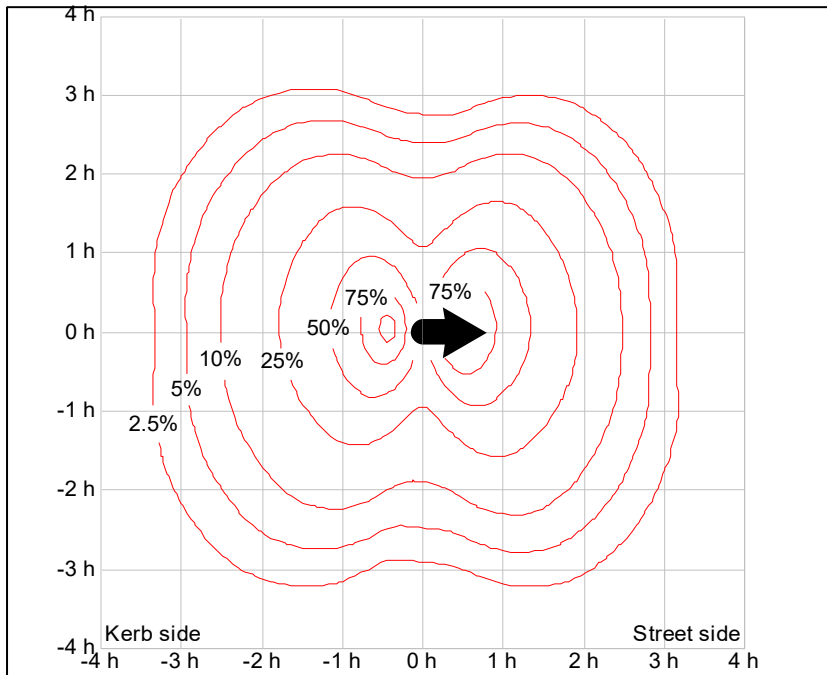

$$E \text{ (lux)} = \frac{E_{\text{max}} \times E\% \times F}{h^2 \times 1000}$$

$E_{\text{max}} = 134.4 \text{ / m / klm}$
luminous flux for the chosen lamp (lm)
Mounting height (m)

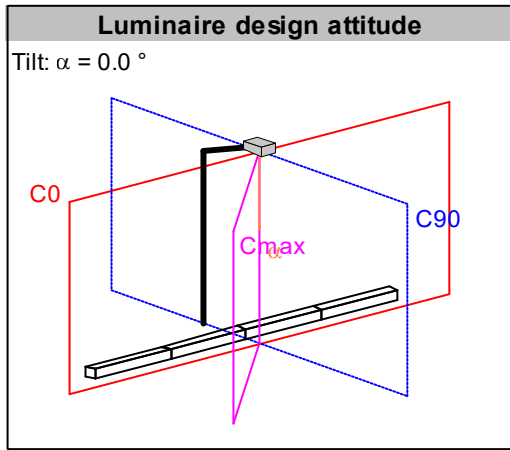

Maximum intensity

I_{max}	374 cd/klm
C_{max}	40°
γ_{max}	63°

Light Output Ratio

Luminaire design attitude	0.0°
LOR	100.00
ULOR	1.00
DLOR	99.00

Upward light output ratio

3% for a tilt = 20°	5% for a tilt = 23°
10% for a tilt = 29°	15% for a tilt = 34°
20% for a tilt = 39°	25% for a tilt = 44°

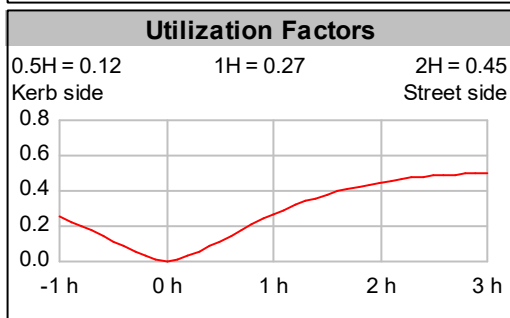
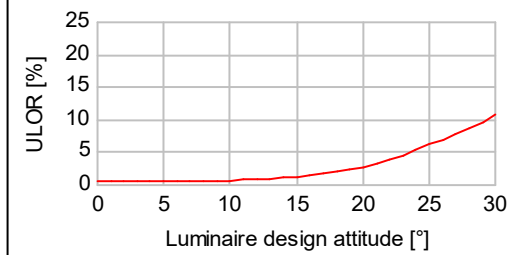

Glare restriction Obtrusive light

Luminous intensity class G3

γ	Meas. Data I_{max} in cd/klm	Specified in EN 13201-2
70°	307	
80°	62	100
90°	4	20
$>95^\circ$	4	