

12320160150

D985 |5| ZPL HX LCKNT/INS MF M16X1,50

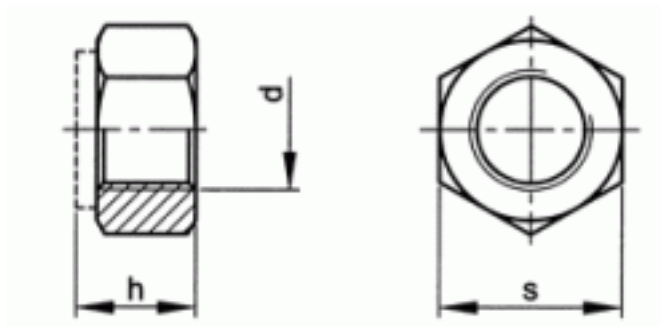

Brand	-
UBB Code	950355291978
UNSPSC Code	31161727
EAN Code	8715492577399
Head shape	hexagon head
Thread	Metric fine thread
Class	≥ 5
Material	Steel
Surface treatment	Zinc plated
Driving features	hexagon



s	23
h	16
P	1,50
d	M16
Packaging (Piece)	50.0



Copyright Fabory Group