

# PRODUCT DATASHEET

## FL FLEX P 40W ML 830 A55X120 WAL

FLOODLIGHT FLEX ASYMMETRIC 55 X 120 | Floodlight with wide beam, asymmetric light distribution for various applications



### Areas of application

- Coastal areas, like ports
- General outdoor area lighting
- Parking
- Suitable for indoor and outdoor sports facilities
- Architectural lighting
- Industry
- Direct replacement for luminaires using HID lamps

### Product benefits

- Corrosion resistance C5: tested in environments with high salinity
- Serviceable luminaire: LED driver can be replaced
- Flexible application due to a range of different lumen packages and beam angles
- 3 cable entries for flexible use and easy connection between luminaires
- Integrated breather for preventing condensation inside the luminaire
- Energy savings of up to 91 % compared to halogen lamp floodlights
- Energy savings of up to 51 % compared to luminaires that use conventional discharge lamps
- No upper light output ratio (ULOR 0%) when mounted at 0° tilt
- Intelligent design of the water drain to prevent standing water
- Simple angle adjustment by locking every 2.5°
- Clear angular degree indication
- Key hole to ensure ease of installation

### Product features



- Corrosion resistance C5 based on 1,500 hours salt mist spray test
- High luminous efficacy: up to 161 lm/W
- Multi Lumen function: 4 lumen steps selectable
- Daisy chaining possible
- High surge protection: up to 10 kV (L/N-PE), 6 kV (L-N)
- High lifetime (L70/B50): up to 120,000 h (at 25 °C)
- Lumen packages up to 70000 lm
- Additional 2200 K color temperature version available

## TECHNICAL DATA

### Electrical data

Nominal wattage	40 W / 34 W / 28 W / 22 W
Nominal voltage	220...240 V
Mains frequency	50...60 Hz
Nominal current	184.000 mA
Inrush current	66.4 A
Inrush current time $T_{h50}$	166 $\mu$ s
Max. number of luminaires per miniature circuit breaker B16	12
Max. number of luminaires per miniature circuit breaker C10	12
Max. number of luminaires per miniature circuit breaker C16	20
Power factor $\lambda$	> 0.90
Total harmonic distortion	< 20 %
Protection class	I
Surge capability (L-N)	6 kV
Surge capability (L/N-Ground)	10 kV
Operating mode	Integrated LED driver

### Photometrical data

Luminous flux	5900 lm / 5000 lm / 4200 lm / 3400 lm
Luminous efficacy	148 lm/W / 147 lm/W / 150 lm/W / 155 lm/W
Color temperature	3000 K
Light color (designation)	Warm White
Color rendering index Ra	> 80
Standard deviation of color matching	5 sdc <sub>m</sub>
Luminous intensity	3626 cd
Low flicker	Yes
Flickering metric (Pst LM)	<1
Stroboscope effect metric (SVM)	<0.4
Photobiological safety group acc. to EN62778	RG1
Beam angle	55 ° x 120 °

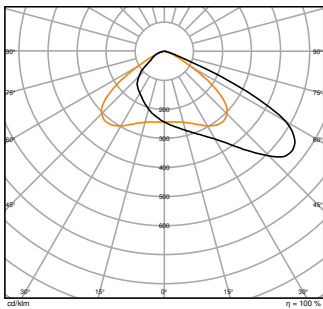

FL FLEX P 40W ML 830 A55X120  
WAL LEDV

### Dimensions & Weight

Length	406.00 mm
Width	277.00 mm
Height	67.00 mm
Product weight	3600.00 g

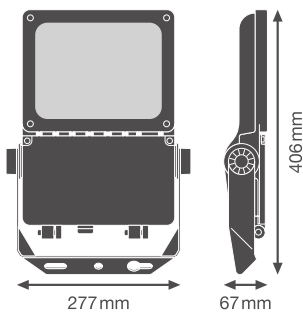

FL FLEX P WAL

### Materials & Colors

Product color	White aluminum
Housing color	White aluminum
RAL Color (most similar)	RAL 9006
Body material	Aluminum
Cover material	Glass
Light emitting surface material	Glass

Glow Wire Test according to IEC 60695-2-12	850 °C
Mercury content	0.0 mg

### Application & Mounting

Ambient temperature range	-30...+50 °C
Temperature range at storage	-30...+80 °C
Type of connection	Screwless terminal
Type of protection	IP66
Protection class IK (shock resistance)	IK08
Corrosion resistance class acc. to EN 12944	C5
Dimmable	No
Mounting type	Surface
Mounting location	Wall / Pole / Floor / Ceiling
Application environment	Outdoor
Adjustable	Yes
With light source	Yes
Replaceable light source	No

### Lifespan

Lifespan L70/B50 at 25 °C	120000 h <sup>1)</sup>
Lifespan L80/B10 at 25 °C	100000 h <sup>1)</sup>
Lifespan L80/B50 at 25 °C	100000 h
Lifespan L90/B10 at 25 °C	50000 h
Number of switching cycles	100000

<sup>1)</sup> t[h]: L70 / B50 @ 25 °C (Ta), t[h]: L80 / B10 @ 25 °C (Ta), t[h]: L90 / B10 @ 25 °C (Ta)

### Control gear

Output current	1300 mA
ECG - Output ripple current	< 10 %

### Certificates & Standards



Standards	CE / CB / ENEC / UKCA
Luminaire with limited surface temperature, "D sign"	Yes
Ball shot safe	Yes
Replaceable light source (EPREL)	Not replaceable

### Additional product data

Added function

MULTI SELECT







## Accessories Optional









Product image	Product name	EAN
	FL TRAVERSE 1/2 42/60/76MM	4099854680038
	FL FLEX ADAPTER SOCKET ZHAGA	4099854680076
	FL FLEX ADAPTER SOCKET NEMA	4099854680113

## EQUIPMENT / ACCESSORIES

- Delivery without cables
- Second cable gland included
- 2 rubber inserts for 6,5 - 7,5 mm cables included

## DOWNLOAD DATA

Documents and certificates	Document name
 User instruction / safety instructions	FL FLEX P ON-OFF
 Legal information	Informationstext 18 Abs 4 ElektroG
 Legal information	Safety Insert G11205497
 Legal information	LSI FL FLEX
 Legal information	Legal insert G11231557
 Declarations of conformity	CE FL FLEX P
 Declarations of conformity UKCA	UKCA FL FLEX P

Documents and certificates		Document name
	Certificates	ENEC FL FLEX P
Photometric and lighting design files		Document name
	IES file (IES)	FL FLEX P 40W ML 830 A55X120 WAL LEDV
	LDT file (Eulumdat)	FL FLEX P 40W ML 830 A55X120 WAL LEDV
	ULD file (DIALux)	FL FLEX P 40W ML 830 A55X120 WAL
	ROLF file (RELUX)	FL FLEX P 40W ML 830 A55X120 WAL
	Light distribution curve type polar	FL FLEX P 40W ML 830 A55X120 WAL LEDV
CAD/BIM files		Document name
	BIM Revit 3D	Floodlight Flex
	CAD STEP 3D	FL FLEX 40W
Tender texts		Document name
	Tender documents	FLOODLIGHT FLEX ASYMMETRIC 55 X 120 40W ML 830 A55X120 WAL-en

LOGISTICAL DATA

Product code	Packaging unit (Pieces/Unit)	Dimensions (length x width x height)	Gross weight	Volume
4099854373176	Shipping box 1	482 mm x 322 mm x 114 mm	4605.00 g	17.69 dm <sup>3</sup>

The mentioned product code describes the smallest quantity unit which can be ordered. One shipping unit can contain one or more single products. When placing an order, for the quantity please enter single or multiples of a shipping unit.

ADDITIONAL CATALOG INFORMATION

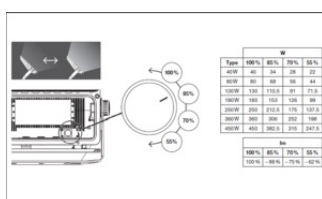

---

### References / Links

– For Guarantee see [www.ledvance.com/guarantee](http://www.ledvance.com/guarantee)

---

### DISCLAIMER

Subject to change without notice. Errors and omission excepted. Always make sure to use the most recent release.