

PRODUCT DATASHEET

PL CMFT 600 P 33W 830 U19 DALIVR

PANEL COMFORT 600 UGR<19 DALI | Square recessed panel luminaire with low glare, for 600 x 600 mm ceiling systems and DALI-2 IoT technology



Areas of application

- Direct replacement for recessed luminaires with fluorescent lamps
- Offices, conference rooms
- Reception areas, foyers, corridors, elevators
- Suitable for recessed ceiling systems with grid size of 600 x 600 mm

Product benefits

- Suitable luminaire for VIVARES and other DALI-2 Light Management Systems
- Tool-free electrical connection due to push button connector
- Through-wiring possible with included connector box
- Energy savings thanks to high system efficacy: up to 130 lm/W
- Good glare reduction (UGR < 19)
- High color consistency with SDCM 3
- Extended services such as energy monitoring and remote maintenance possible with DALI versions
- External driver for extended flexibility and easy installation
- Low flicker light thanks to special electronic control gear
- Suitable for emergency lighting
- 5 years guarantee

Product features

- IoT-ready luminaire with DALI-2 technology



- Suitable for central battery emergency installations acc. to EN 60598-2-22
- Push DIM function for dimming and switching directly on a pushbutton
- Versions available with CRI 90
- Extruded aluminum frame
- Polystyrene diffuser
- 5-pole terminal block, cable cross section up to 5 x 2.5 mm²
- Lifetime (L80/B10): 70,000 h (at 25 °C)

TECHNICAL DATA

Electrical data

Nominal wattage	33.00 W ¹⁾
Nominal voltage	220...240 V
Mains frequency	0/50/60 Hz
Nominal current	150.000 mA
Inrush current	4.4 A
Inrush current time T_{h50}	440 μ s
Max. number of luminaires per miniature circuit breaker B16	40
Max. number of luminaires per miniature circuit breaker C10	40
Max. number of luminaires per miniature circuit breaker C16	65
Power factor λ	> 0.90
Total harmonic distortion	< 20 %
Protection class	II
Operating mode	External LED driver
Dimming interface	DALI-2 / IoT

¹⁾ CRI80 versions of the Panel Comfort family are fulfilling the technical minimum requirements according to the German BEG subsidy program for energy efficient luminaires

Photometrical data

Luminous flux	4320 lm ¹⁾
Luminous efficacy	130 lm/W ¹⁾
Color temperature	3000 K
Light color (designation)	Warm White
Color rendering index Ra	> 80
Standard deviation of color matching	\leq 3 sdc _m
Low flicker	Yes
Flickering metric (Pst LM)	<1
Stroboscope effect metric (SVM)	< 0.4
Photobiological safety group acc. to EN62778	RG0
Beam angle	90 °
UGR	< 19

¹⁾ CRI80 versions of the Panel Comfort family are fulfilling the technical minimum requirements according to the German BEG subsidy program for energy efficient luminaires

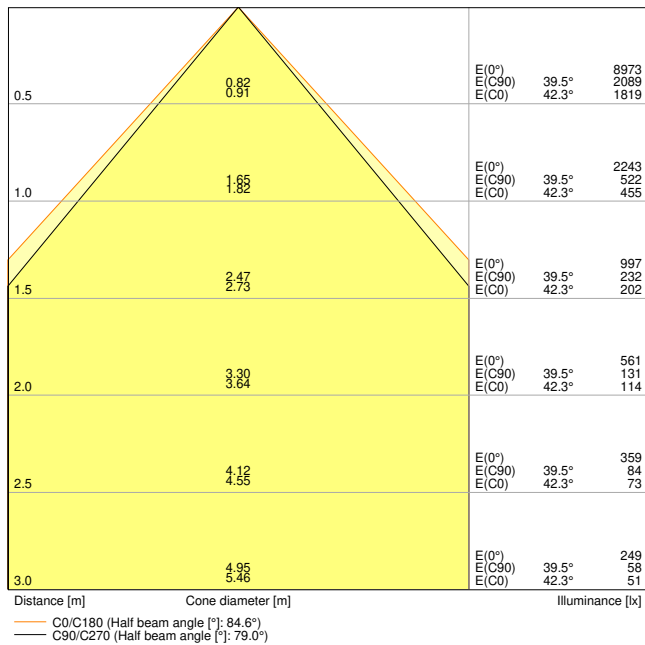

PL CMFT 600 P 33W 830 U19 DALIVR

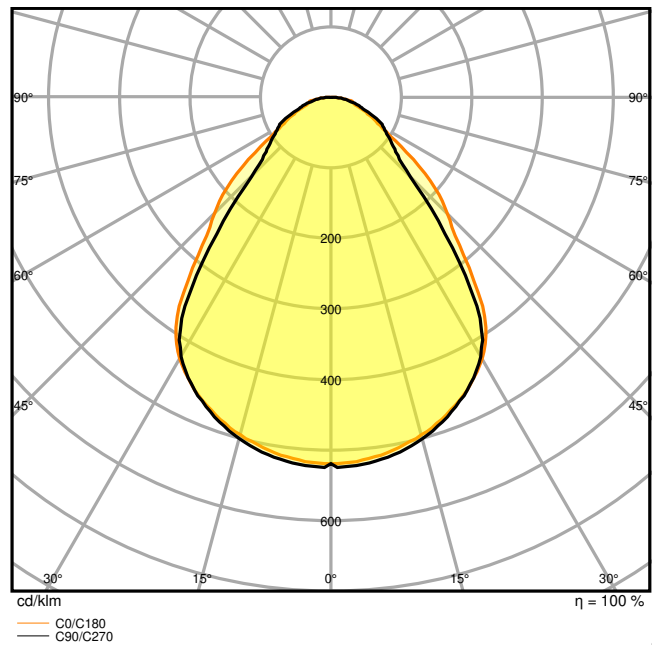

PL CMFT 600 P 33W 830 U19 DALIVR

Dimensions & Weight

Length	595.00 mm
Width	595.00 mm
Height	32.00 mm
Product weight	1800.00 g

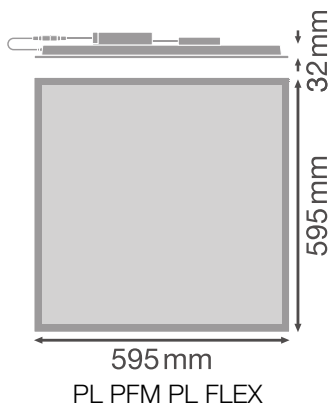

Materials & Colors

Product color	White
---------------	-------

Housing color	White
RAL Color (most similar)	RAL 9003
Body material	Steel
Cover material	Polystyrene (PS)
Light emitting surface material	Polystyrene
Glow Wire Test according to IEC 60695-2-12	650 °C
Mercury content	0.0 mg

Application & Mounting

Ambient temperature range	-10...+50 °C
Temperature range at storage	-20...+80 °C
Type of connection	Screwless terminal, 5-Pole (L, N, PE, DA+, DA-)
Type of protection	IP40/IP20
Protection class IK (shock resistance)	IK02
Dimmable	Yes
Type of dimming	DALI-2
IoT ready	Support of DALI data type PART 251, 252, 253 ¹⁾
Mounting type	Recessed/Suspended/Surface
Mounting location	Ceiling
Application environment	Indoor
Mounting length	575 mm
Mounting width	575 mm
Mounting depth	50,0 mm
Adjustable	No
With light source	Yes
Replaceable light source	No

¹⁾ Internet of Things. Supports data transfer via gateway to cloud-based monitoring platforms, such as LEDVANCE VIVARES Cloud

Lifespan

Lifespan L70/B50 at 25 °C	100000 h ¹⁾
Lifespan L80/B10 at 25 °C	70000 h ¹⁾
Lifespan L80/B50 at 25 °C	70000 h
Lifespan L90/B10 at 25 °C	48000 h
Number of switching cycles	50000

¹⁾ t[h]: L70 / B50 @ 25 °C (Ta), t[h]: L80 / B10 @ 25 °C (Ta), t[h]: L90 / B10 @ 25 °C (Ta)

Control gear

Output current	730 mA
ECG - Output ripple current	< 5 %
ECG - Length	209,00 mm
ECG - Width	42.5 mm
ECG - Height	30 mm
Recommended control gear	OSRAM OTI DALI 50/220-240/1A4 NFC; Tridonic LCA 45W 500-1400mA one4all SC PRE

Emergency lighting

Type of Emergency Lighting (EL)	Optional EL unit (battery and controller) for decentral operation available separately / EL certified driver (0Hz / DC operation) for central battery operation included
Wattage in emergency operation mode	6 W
Luminous flux in emergency operation mode	590 lm



Certificates & Standards



Standards	CE / CB / ENEC / UKCA / EAC / EPD
Luminaire with limited surface temperature, "D sign"	No
Ball shot safe	No
EPD	LEDV-00011-V01.01-EN
Replaceable light source (EPREL)	Not replaceable

Additional product data

Added function	VIVARES
----------------	---------

Accessories Optional



Product image	Product name	EAN
	EM CONVERSION BOX	4058075237025
	PANEL 600 SURFACE MOUNT KIT H75	4058075472914











Product image	Product name	EAN
	PANEL 600 SURFACE MOUNT KIT H70 VAL	4058075402843
	PANEL RECESSED MOUNT CLIPS VAL 4x	4058075409859
	PANEL Suspension Kit	4058075402928



EQUIPMENT / ACCESSORIES

- Accessories for several mounting options available
- Connector box with 5-pole terminal included
- Security rope for luminaire included
- Security brackets preinstalled
- External control gear included
- Suitable for use with separate Emergency Conversion Box











Upgrade and replacement components

Components Light Control		
Product image	Product name	EAN
	MANUAL CONTROL UNIT SELECT DALI-2	4058075837485
	MANUAL CONTROL UNIT SELECT DALI-2 TW	4058075837508
	MANUAL CONTROL UNIT SELECT DALI-2 EXCHANGEABLE COVER TW	4058075837522







Product image	Product name	EAN
	MANUAL CONTROL UNIT TOUCH DALI-2 TW	4058075837560
	MANUAL CONTROL UNIT TOUCH DALI-2	4058075837546
	PUSH CONTROL UNIT FLUSH MOUNT DALI-2 TW	4058075837584
	SURFACE MOUNT FRAME	4058075843561
	PUSHBUTTON COUPLER DALI-2	4058075837607
	FLEX CONTROL UNIT IOT DALI-2 HCL TW	4058075841888
	FLEX CONTROL UNIT FLUSH MOUNT DALI-2 TW	4058075841901
	FLEX CONTROL UNIT DALI-2 TW	4058075843844
	FLEX CONTROL UNIT REAL-TIME-CLOCK DALI-2 HCL TW	4058075841925
	SENSOR DALI-2 LIGHT/PRESENCE-6 INFRARED CEILING INTEGRATION	4058075837621
	SENSOR DALI-2 LIGHT/PRESENCE-8 INFRARED CEILING INTEGRATION	4058075841949



Product image	Product name	EAN
	SENSOR DALI-2 LIGHT/PRESENCE-40X5 INFRARED CEILING INTEGRATION	4058075843868
	SENSOR DALI-2 LIGHT/PRESENCE-24 INFRARED CEILING MOUNTING	4058075843882
	DALI sensors -8 IR CI, -40X5 IR CI, -24 IR CM, -21 IR CM	4058075843905

DOWNLOAD DATA

Documents and certificates	Document name
 User instruction / safety instructions	PL CMFT P DALIVR
 Legal information	LISO Insert Panel CMFT 600 P DALI and 625 P DALI
 Legal information	Informationstext 18 Abs 4 ElektroG
 Legal information	EM Insert PL COMFORT
 Declarations of conformity	CE Declaration PL CMFT DALI
 Declarations of conformity	CE Declaration PL CMFT DALIVR
 Declarations of conformity UKCA	UKCA Declaration PL CMFT DALI
 Declarations of conformity UKCA	UKCA Declaration PL CMFT DALIVR
 Declarations of conformity UKCA	PL COMFT DALIVR
 Declarations of conformity UKCA	PL COMFT P DALIVR
 EU Data Act	DALI LED Driver and Luminaires

Documents and certificates		Document name
	EPD	EPD EN PANEL COMFORT BACKLIT DALI

Photometric and lighting design files		Document name
	IES file (IES)	PL CMFT 600 P 33W 830 U19 DALIVR
	LDT file (Eulumdat)	PL CMFT 600 P 33W 830 U19 DALIVR
	ULD file (DIALux)	PL CMFT 600 P 33W
	ROLF file (RELUX)	PL CMFT 600 P
	UGR file (UGR table)	PL CMFT 600 P 33W 830 U19 DALIVR
	Light distribution curve type cone	PL CMFT 600 P 33W 830 U19 DALIVR
	Light distribution curve type polar	PL CMFT 600 P 33W 830 U19 DALIVR

CAD/BIM files		Document name
	BIM Revit 3D	PL_CMFT
	CAD STEP 3D	PL_CMFT_600

Tender texts	Document name
	Tender documents PANEL COMFORT 600 UGR19 DALI 33W 830 U19 DALIVR-EN

LOGISTICAL DATA

Product code	Packaging unit (Pieces/Unit)	Dimensions (length x width x height)	Gross weight	Volume
4099854015304	Folding box 1	52 mm x 622 mm x 649 mm	2255.00 g	20.99 dm ³
4099854015311	Shipping box 4	647 mm x 222 mm x 724 mm	10102.00 g	103.99 dm ³

The mentioned product code describes the smallest quantity unit which can be ordered. One shipping unit can contain one or more single products. When placing an order, for the quantity please enter single or multiples of a shipping unit.

ADDITIONAL CATALOG INFORMATION

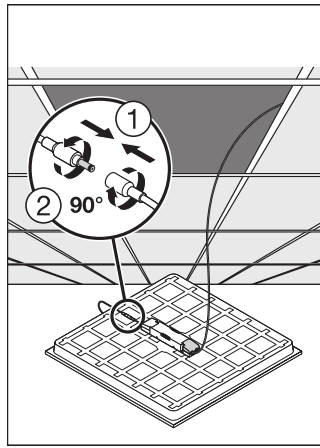
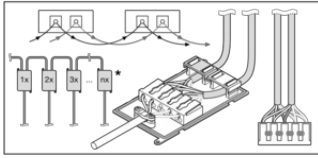

References / Links

– For Guarantee see www.ledvance.com/guarantee

DISCLAIMER

Subject to change without notice. Errors and omission excepted. Always make sure to use the most recent release.