

# PRODUCT DATASHEET

## PL CMFT 600 P 33W 865 PS

PANEL COMFORT 600 PS | Square recessed panel luminaires with power select (PS) feature, for 600 x 600 mm ceiling systems



### Areas of application

- Direct replacement for recessed luminaires with fluorescent lamps
- Offices, conference rooms
- Reception areas, foyers, corridors, elevators
- Suitable for recessed ceiling systems with grid size of 600 x 600 mm

### Product benefits

- Highly versatile due to selectable power steps (Power Select - PS) on the driver
- Tool-free electrical connection due to push button connector
- Through-wiring possible with included connector box
- Energy savings thanks to high system efficacy: up to 130 lm/W
- High color consistency with SDCM 3
- Extended services such as energy monitoring and remote maintenance possible with DALI versions
- External driver for extended flexibility and easy installation
- Low flicker light thanks to special electronic control gear
- Emergency lighting possible with LEDVANCE Emergency Conversion Box
- 5 years guarantee

### Product features

- Extruded aluminum frame
- Polystyrene diffuser



- 5-pole terminal block, cable cross section up to 5 x 2.5 mm<sup>2</sup>
- Luminaire versions with IoT-ready DALI-2 driver available
- Lifetime (L80/B10): 70,000 h (at 25 °C)

## TECHNICAL DATA

### Electrical data

Nominal wattage	33 W / 30 W / 28 W <sup>1)</sup>
Nominal voltage	220...240 V
Mains frequency	50...60 Hz
Nominal current	150.000 mA
Inrush current	9 A
Inrush current time $T_{h50}$	690 $\mu$ s
Max. number of luminaires per miniature circuit breaker B16	14
Max. number of luminaires per miniature circuit breaker C10	15
Max. number of luminaires per miniature circuit breaker C16	24
Power factor $\lambda$	> 0.90
Total harmonic distortion	< 20 %
Protection class	II
Operating mode	External LED driver

<sup>1)</sup> For possible options refer to lumen/power table image / CRI80 versions of the Panel Comfort family are fulfilling the technical minimum requirements according to the German BEG subsidy program for energy efficient luminaires

### Photometrical data

Luminous flux	4320 lm / 3900 lm / 3640 lm <sup>1)</sup>
Luminous efficacy	130 lm/W <sup>1)</sup>
Color temperature	6500 K
Light color (designation)	Cool Daylight
Color rendering index Ra	> 80
Standard deviation of color matching	$\leq$ 3 sdc <sub>m</sub>
Low flicker	Yes
Flickering metric (Pst LM)	<1
Stroboscope effect metric (SVM)	< 0.4
Photobiological safety group acc. to EN62778	RG0
Beam angle	110 °

<sup>1)</sup> For possible options refer to lumen/power table image / CRI80 versions of the Panel Comfort family are fulfilling the technical minimum requirements according to the German BEG subsidy program for energy efficient luminaires

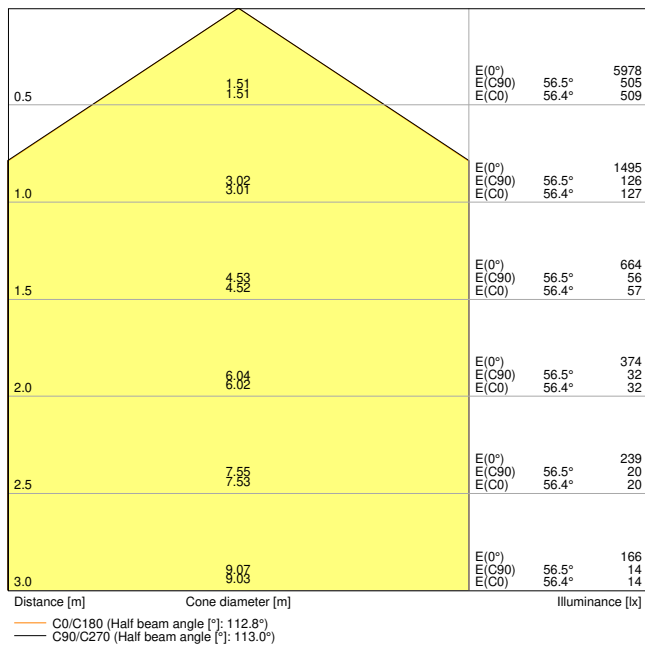

PL CMFT 600 P 33W 865 PS

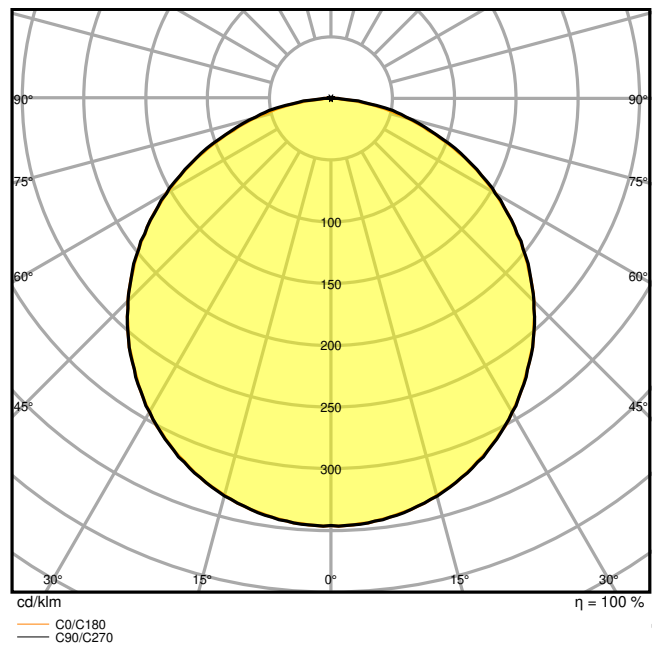

PL CMFT 600 P 33W 865 PS

### Dimensions & Weight

Length	595.00 mm
Width	595.00 mm
Height	32.00 mm
Product weight	1600.00 g

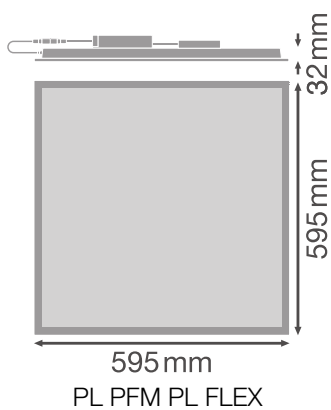

### Materials & Colors

Product color	White
Housing color	White
RAL Color (most similar)	RAL 9003
Body material	Steel
Cover material	Polystyrene (PS)
Light emitting surface material	Polystyrene
Glow Wire Test according to IEC 60695-2-12	650 °C
Mercury content	0.0 mg

### Application & Mounting

Ambient temperature range	-10...+50 °C
Temperature range at storage	-20...+80 °C
Type of connection	Screwless terminal, 5-Pole (L, N, PE, DA+, DA-)
Type of protection	IP40/IP20
Protection class IK (shock resistance)	IK02
Dimmable	No
Mounting type	Recessed/Suspended/Surface
Mounting location	Ceiling
Application environment	Indoor
Mounting length	575 mm
Mounting width	575 mm
Mounting depth	50,0 mm
Adjustable	No
With light source	Yes
Replaceable light source	No

### Lifespan

Lifespan L70/B50 at 25 °C	100000 h <sup>1)</sup>
Lifespan L80/B10 at 25 °C	70000 h <sup>1)</sup>
Lifespan L80/B50 at 25 °C	70000 h
Lifespan L90/B10 at 25 °C	48000 h
Number of switching cycles	50000

<sup>1)</sup> t[h]: L70 / B50 @ 25 °C (Ta), t[h]: L80 / B10 @ 25 °C (Ta), t[h]: L90 / B10 @ 25 °C (Ta)

### Control gear

Output current	730 mA
----------------	--------

ECG - Output ripple current	< 5 %
ECG - Length	143 mm
ECG - Width	49 mm
ECG - Height	30 mm
Recommended control gear	OSRAM OTI DALI 50/220-240/1A4 NFC; Tridonic LCA 45W 500-1400mA one4all SC PRE

**Emergency lighting**

Type of Emergency Lighting (EL)	Optional EL unit (battery and controller) for decentral operation available separately
---------------------------------	--





**Certificates & Standards**

Standards	CE / CB / ENEC / UKCA / EAC / EPD
Luminaire with limited surface temperature, "D sign"	No
Ball shot safe	No
EPD	LEDV-00011-V01.01-EN

**Additional product data**

Added function	MULTI SELECT
----------------	--------------

**Accessories Optional**











Product image	Product name	EAN
	EM CONVERSION BOX	4058075237025
	PANEL 600 SURFACE MOUNT KIT H75	4058075472914
	PANEL 600 SURFACE MOUNT KIT H70 VAL	4058075402843
	PANEL RECESSED MOUNT CLIPS VAL 4x	4058075409859







Product image	Product name	EAN
	PANEL Suspension Kit	4058075402928



## EQUIPMENT / ACCESSORIES

- Accessories for several mounting options available
- Connector box with 5-pole terminal included
- Security rope for luminaire included
- Security brackets preinstalled
- External control gear included
- Suitable for use with separate Emergency Conversion Box

## DOWNLOAD DATA

Documents and certificates	Document name
 User instruction / safety instructions	PL CMFT P PS
 Legal information	LISO Insert Panel CMFT 600 P and 625 P
 Legal information	Informationstext 18 Abs 4 ElektroG
 Legal information	EM Insert PL COMFORT
 Declarations of conformity	CE Declaration PL CMFT PS
 Declarations of conformity UKCA	UKCA Declaration PL CMFT PS
 EPD	EPD EN PANEL COMFORT BACKLIT DALI
Photometric and lighting design files	Document name
 IES file (IES)	PL CMFT 600 P 33W 865 PS
 LDT file (Eulumdat)	PL CMFT 600 P 33W 865 PS
 ULD file (DIALux)	PL CMFT 600 P 33W 865

Photometric and lighting design files	Document name
 ROLF file (RELUX)	PL CMFT 600 P 33W 865
 UGR file (UGR table)	PL CMFT 600 P 28W 865 PS
 UGR file (UGR table)	PL CMFT 600 P 30W 865 PS
 UGR file (UGR table)	PL CMFT 600 P 33W 865 PS EM CONVERSION BOX
 UGR file (UGR table)	PL CMFT 600 P 33W 865 PS
 Light distribution curve type cone	PL CMFT 600 P 33W 865 PS
 Light distribution curve type polar	PL CMFT 600 P 33W 865 PS

CAD/BIM files	Document name
 BIM Revit 3D	PL_CMFT
 CAD STEP 3D	PL_CMFT_600

Tender texts	Document name
 Tender documents	PANEL COMFORT 600 PS 33W 865 PS-EN

### LOGISTICAL DATA

Product code	Packaging unit (Pieces/Unit)	Dimensions (length x width x height)	Gross weight	Volume
4099854014901	Folding box 1	52 mm x 622 mm x 694 mm	2055.00 g	22.45 dm <sup>3</sup>
4099854014918	Shipping box 4	647 mm x 222 mm x 724 mm	9302.00 g	103.99 dm <sup>3</sup>

The mentioned product code describes the smallest quantity unit which can be ordered. One shipping unit can contain one or more single products. When placing an order, for the quantity please enter single or multiples of a shipping unit.

### ADDITIONAL CATALOG INFORMATION

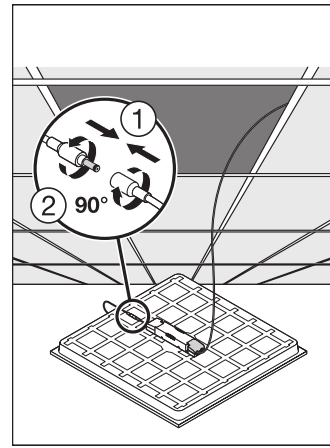
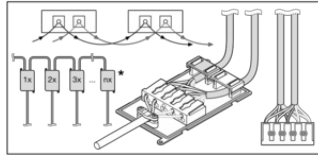
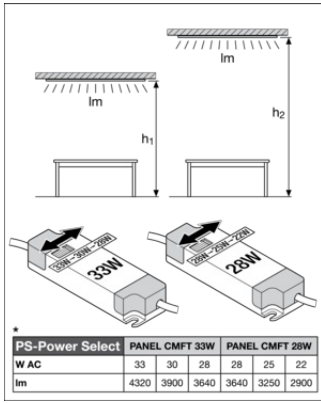

### References / Links

– For Guarantee see [www.ledvance.com/guarantee](http://www.ledvance.com/guarantee)

### DISCLAIMER

Subject to change without notice. Errors and omission excepted. Always make sure to use the most recent release.