

16250080001

ZPL CL.04 WING NT LIGHT (AM) M8

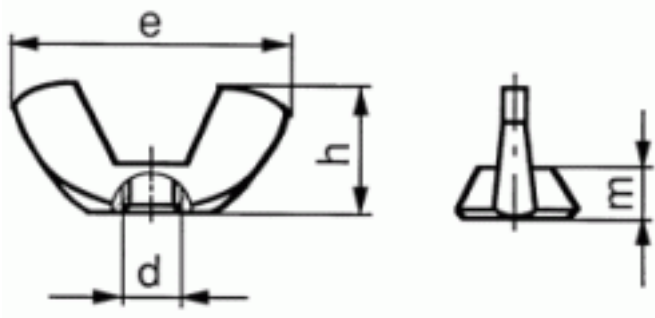

Brand	-
UBB Code	950355162773
UNSPSC Code	31161717
EAN Code	8715492590336
Thread	Metric thread
Class	04
Material	Steel
Surface treatment	Zinc plated
Driving features	wing



h ≈	14,8
e ≈	30,3
m ≈	5,4
P	1,25
d	M8
Packaging (Piece)	100.0



Copyright Fabory Group