

12410220001

D985 |10| ZPL HX LCKNT/INS M22

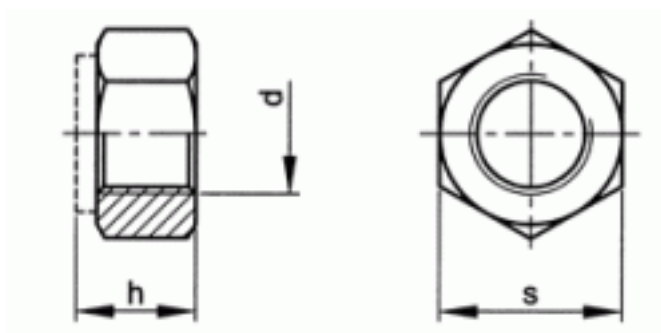

Brand	-
UBB Code	950355768835
UNSPSC Code	31161727
EAN Code	8715492578570
Driving features	hexagon
Thread	Metric thread
Class	10
Material	Steel
Surface treatment	Zinc plated



s	32
h	22
P	2,5
d	M22
Packaging (Piece )	25.0



Copyright Fabory Group