



# aquatherm red pipe

**Pipe system made of polypropylene**  
for fire sprinkler systems



**aquatherm**  
state of the pipe



Our sales and delivery conditions (January 2014) and the contacts of our technical sales and distribution see on our homepage [www.aquatherm.de](http://www.aquatherm.de).

Subject to technical alterations, errors and misprints excepted. With the edition of this catalogue, all former ones become void.



**Dear readers,**

We are always making decisions – in every minute of every hour of every day. At this moment, you have decided to open our “Company brochure” to consciously find out more about our company aquatherm.

Without knowing the reason behind your decision, we can promise you one thing, namely that the insight into our colourful, yet always slightly green tinged, aquatherm world is sure to impress you!

As a family business which is passionate about all it does we, together with our employees, confidently meet all challenges and, in doing so, are able to trustfully call upon values which have defined our company for already more than four successful decades.

We know where we want to go without forgetting where we came from. Hereby we like to live with the role of not being a “normal” business. The characteristics “being different” and “special” represent our motivation in all that we do to be the best.

We are “state of the pipe” because we act independently and decisively and are hereby always reliable which makes us the leading manufacturer of polypropylene pipes.

We were, are and will remain as this – promise!

But see for yourself and decide upon aquatherm not only in the next few moments but also in the long term.

Best wishes

**Christof Rosenberg**  
Managing Director

**Dirk Rosenberg**  
Managing Director

**Maik Rosenberg**  
Managing Director

**Gerhard Rosenberg**  
President of the Advisory Board

**1973**

Founding of aquatherm by Gerhard Rosenberg

**1978**

Transfer to the first factory in Biggen/D-Attendorf

**1985**

Completion of factory 1 in Biggen/D-Attendorf

**1992**

Founding of the branch in Radeberg near D-Dresden

**1996**

Founding of the metal processing company aquatherm metal, D-Attendorf

**1998**

Founding of a subsidiary in Carrara/Italy

**1999**

Completion of the main site in D-Attendorf as one complex (Factories 1+2, Production and Store, Laboratory and Training Centre)

**2001**

Completion of the extension Factory 2 in D-Attendorf

**2001**

Opening of the new training centre in D-Radeberg

**2002**

Completion of the logistics centre in D-Attendorf

**2003**

Completion of rebuilding and finishing of the training centre in D-Attendorf

**2003**

30 year celebration of the company aquatherm

**2005**

Adding of 2 storeys on the administration building

**2005/06**

Completion of the 4-storey hall on the premises in Attendorf

Basement: Store

Ground floor: Assembly/Packing

1st Floor: Laboratory and Technical department

2nd Floor: Special manifold construction

**2008**

Aquisition of the former storehouse of the forwarding agent Kost, which also accomodates the room of the plant maintenance.

**2009**

Opening of the new expertise centre for technical application.

**2013**

40 year celebration of the company aquatherm

**2015**

Start of building project ZuRo (future pipe manufacturing)

**TABLE OF CONTENTS**

<b>General</b>	<b>8–12</b>
– Material properties/Advantages	8
– Processing	9
– International approvals	11
– Handling/Transport/Storage	12
<b>Products</b>	<b>13–34</b>
– Pipe/Socket	
– Reducer/Elbow	
– Tee/Cross	
– Sprinkler outlet/End cap/Weld-in saddle	
– Compensating joint	
– Weldable flange adapter/Plastic flange/ Coupling screw joint	
– Transition piece/Transition elbow	
– Threaded branch tee/Transition joint Transition piece for slot connection	
– Weld-in saddle/Pipe cutter	
– Welding device	
– Welding accessories	
– Welding tool/Drill	
– Adjusting tool	
<b>Fusion</b>	<b>35–50</b>
– Part A:	
Mounting of the tools	35
Heat-up phase	36
Handling	36
Guidelines	36
– Part B:	
Checking of devices and tools	37
Preparation for the fusion	38
Heating of pipe and fittings	39
Setting and alignment	39
– Visual inspection of fusion seam	40
– Part C:	
Weld-in saddles	42
Drilling, heat-up, joining, fixing	43
– Part D:	
Welding machine	44
– Part E:	
Welding machine light	45
– Part F:	
Repair	45
– Part G:	
Butt-welding of pipe dimension 160 mm	46
Visual inspection of fusion seam (butt welding)	48
Welding parameters	50

## TABLE OF CONTENTS

<b>Laying of aquatherm red pipe in the concrete</b>	<b>51–61</b>
– Part 1: Connecting of pipe work to the sprinkler outlet	51
– Part 2: Pressure test of pipe work installation as strength test and leak test	59
– Part 3: What must be considered during the concreting process?	59
– Part 4: Access to connection of the pipe work in concrete	60
– Part 5: Bridging of building joints	61
– Part 6: Potential equalizing	61
– Part 7: Pressurizing in the aquatherm red pipe supply during the concreting process	61
– Part 8: Influence of the concrete to the applied compounds	61
<b>Test</b>	<b>62–66</b>
– Leakage test/Pressure diagram	
– Test record aquatherm red pipe system installation	
– Form: “Enquiry for the chemical resistance”	
<b>References</b>	<b>67–82</b>

# SERVICE

## TECHNICAL HOTLINE

+49 (0)2722 950 200

info@aquatherm.de www.aquatherm.de

### Parent plant Attendorf

**aquatherm GmbH**  
Biggen 5  
D-57439 Attendorf  
Phone: +49 (0)2722 950 0  
Fax: +49 (0)2722 950 100

### Subsidiary Radeberg

**aquatherm GmbH**  
Wilhelm-Rönsch-Str. 4  
D-01454 Radeberg  
Phone: +49 (0) 3528 4362-0  
Fax: +49 (0) 3528 4362-30



#### Field staff

In addition to the regular training service at Attendorf and Radeberg aquatherm field staff are available to assist customers, on site, throughout Germany.



#### Training service

In addition to training service through the merchant network aquatherm offers its customers training, free of charge, at its training centres at Attendorf and Radeberg.

#### Fair

aquatherm is represented on all important fairs relevant for the sanitary and heating sector in Germany or abroad with its own exhibition booth. For more information regarding fairs near to you, please visit internet page: [www.aquatherm.de](http://www.aquatherm.de).

## CERTIFICATIONS IN ACCORDANCE WITH ISO 9001, 14001 & 50001

Since 1996 aquatherm has been meeting the requirements of the certifiable quality management system according to DIN ISO 9001. The 2012 TÜV certificate was extended by the environmental management system according to ISO 14001 and currently by the energy management system according to ISO 50001.

This success is a great contribution and represents a further step to strengthen our competitive position and to meet the high requirements and the responsibility for our customers, partners and the environment.



Management System  
ISO 9001:2008  
ISO 14001:2004  
ISO 50001:2011  
www.tuv.com  
ID 0091005348



### Laboratory

The aquatherm laboratory: From the testing of granulate through to the finished product the customer can be assured of only the highest quality products.



### Software-Service

The aquatherm software service provides Datanorm-files, an independent graphical program (liNear), and the appropriate training.



### Brochures etc.

No matter whether brochures, catalogues or product lists: Our in-house marketing department develops everything itself. You can download all documents as pdf from our website [www.aquatherm.de](http://www.aquatherm.de). For printed copies, please send an e-mail to [info@aquatherm.de](mailto:info@aquatherm.de).

# SERVICE

# aquatherm red pipe

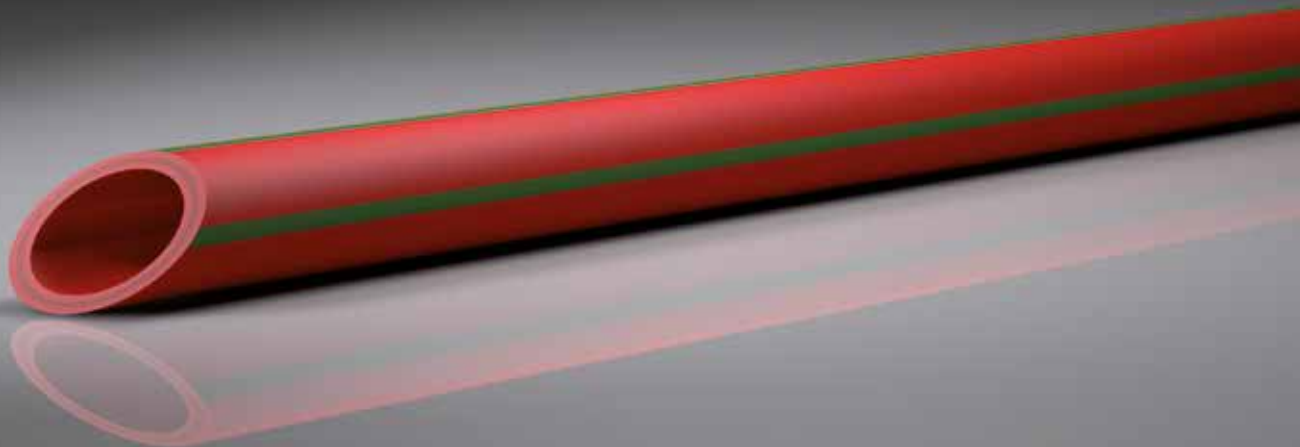

## ADVANTAGES

- Certified and quality inspected
- Connection by fusion welding
- Resistant against corrosion and chemicals
- No accumulation of corrosion products
- Low pipe roughness factor and high abrasion resistance
- Heat- and sound-insulating characteristics
- High impact strength
- Leak-proof connection of pipe and fitting by fusion technique
- Not easily flammable acc. to DIN 4102-1, building material class B1
- Low weight compared to metal pipes
- Short processing time
- No gaskets – sealing elements are not required
- 3-layer pipe with fibre glass reinforced inner layer
- Concealed fire protection
- Reduction of structural work costs by laying in concrete
- Weld-in saddle

aquatherm red pipe offers an extensive range of pipes and fittings for the installation of fire sprinkler systems.

The system is based on a fibre reinforced polypropylene pipe (faser composite pipe) produced in a multi-layer extrusion process.

The material fusiolen® PP-R FS, used for the pipe production, is a plastic whose properties are designed for the special demands of the fields of application. Both, the installer's request for easier processing and the demand for maximum safety in later application, was regarded during the development.

## aquatherm red pipe is:

### Connection by fusion welding

No sealants or adhesives are required for this permanent connection.

### Corrosion-proof

Prevents the clogging of the sprinkler with corrosive material. This ensures a long, low-maintenance service life as well as failure-free functioning of the system.

The production of pipes and fittings is controlled according to the highest quality standards on most modern injection moulding machines and extrusion lines. The high quality of our products is guaranteed by extensive controls of incoming goods and the production process.

The aquatherm quality management system is certified according to DIN EN ISO 14001:2004, 9001:2008 and 50001:2011.



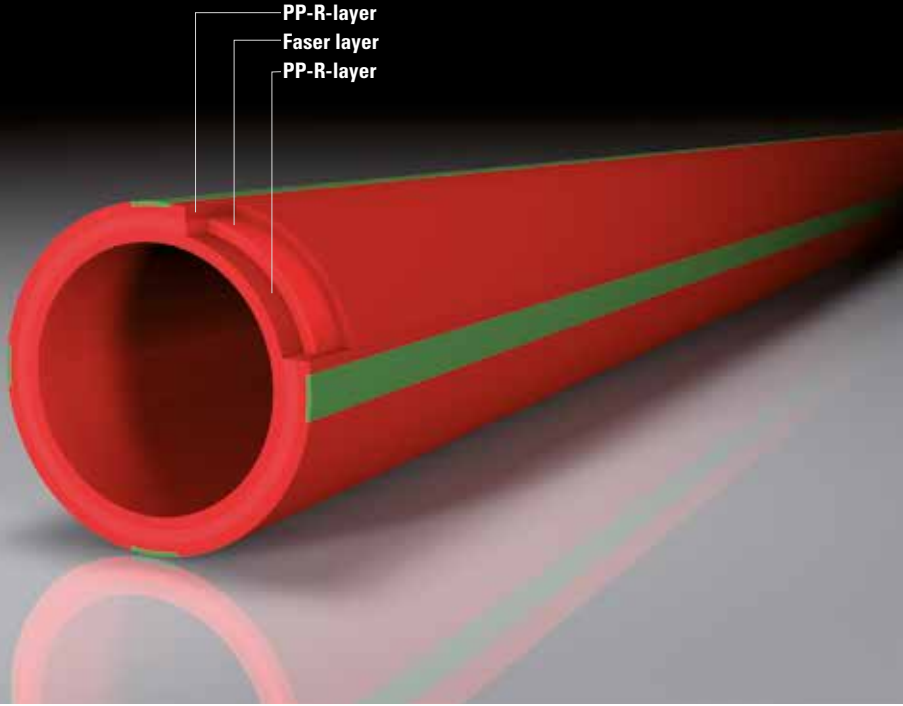

**PROCESSING**

**Fusion technique**

By the fusion of pipe and fitting the plastic melts to a homogeneous material unit.

Pipe and fitting are heated quickly with specially provided welding tools and joined together – finished!

Double material thickness at the joint – giving double safety at the otherwise critical point of a pipe system.

A permanent leakproof connection is created with the aquatherm fusion technique.

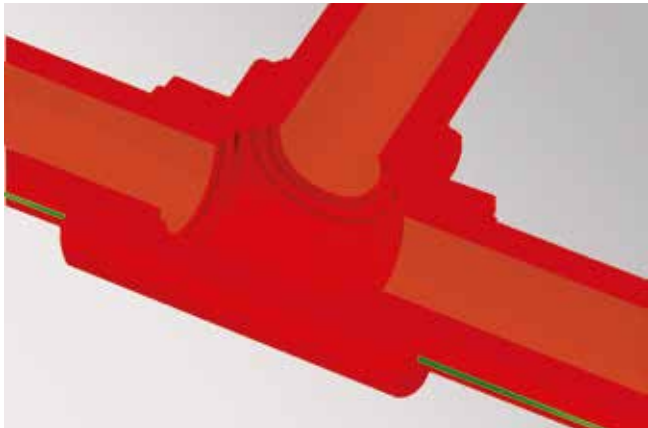

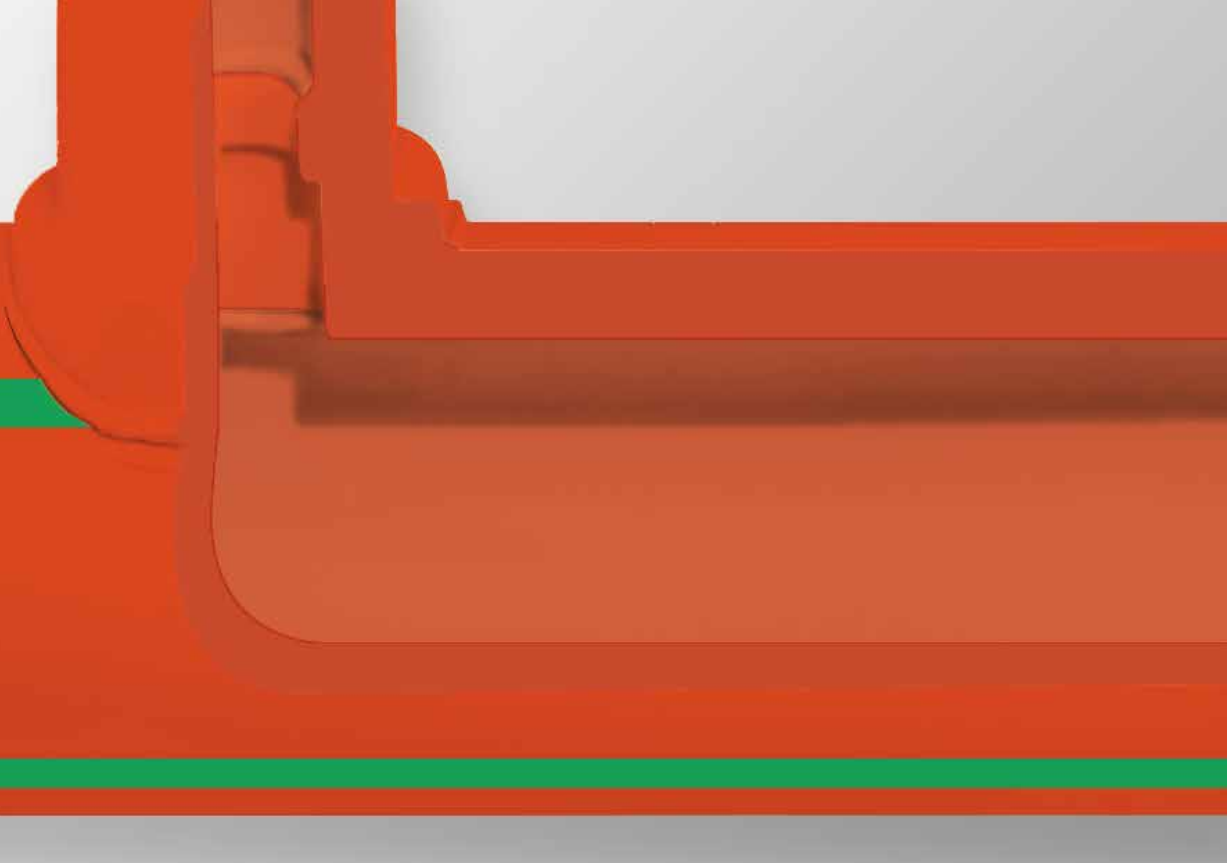

## PROCESSING

### Weld-in saddle technique

Branches can easily be made by weld-in saddles, even post-installation. Material costs and processing time are reduced by using weld-in saddles.

Whereas in case of tees three joints are to be processed, work is limited to mounting the saddle and the branch pipe only.

Simply drill the pipe; heat up the saddle, pipe wall and surface; connect the parts. Finished!



**INTERNATIONAL APPROVALS**  
**for the application as sprinkler lines**

Fire protection requirements and standards for planning and construction of sprinkler systems vary locally.

Thus, the application of aquatherm red pipe in any case has to be agreed and coordinated with the local national fire protection authorities, the constructor and the building insurers.

Further certification either national or local are in process.



Germany



Poland



Hong Kong



Austria



Iceland



New Zealand



FEDERAL STATE ESTABLISHMENT  
THE ALL-RUSSIAN RESEARCH  
INSTITUTE FOR FIRE PROTECTION  
(FGU VNIIPPO)

Russia



Australian  
Standard  
AS 4118.2.1  
Lic SMK P20464

Australia



LPS 1260  
Cert.-no.: 684a

Great Britain



N.º 526/09

Spain



New Zealand

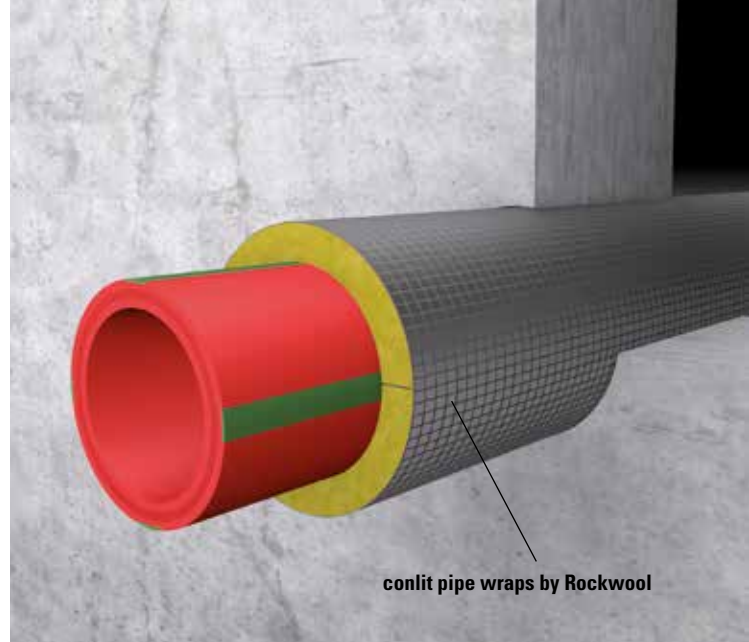
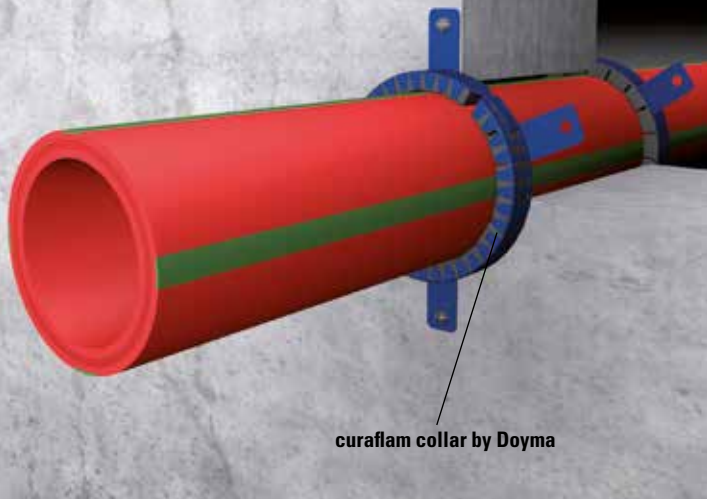

**HANDLING**

**Transport and storage**

aquatherm red pipe pipes can be stored in all outside temperatures. Pipes should be stored and transported flat and fully supported along their length. Bending pressures are to be avoided. High impact should be avoided at extremely low temperatures.

Although aquatherm red pipe pipes are extremely robust, it is recommended to treat the material always with care.

**UV resistance**

Pipes from fusiolen® PP-R FS should not be installed (without protection) where subject to UV-radiation. All aquatherm red pipe pipes and fittings are supplied in UV-protected packaging to bridge transport and assembly time. Ultraviolet rays have an influence on all high polymeric plastics. Hence, pipes should not be stored unprotected outside for a long time. The maximum storage time is (outside) 6 months.

**Fire bulkheading**

All fire prevention systems which can prove equivalent licensing are suited for the aquatherm red pipe system.

**Procedures for additional repair**

Cut out damaged/leaking section and replace as for a new installation or repair with pipe repair stick (page 45).

**Chemical resistance**

On account of the special material qualities aquatherm red pipe pipes and fittings provide extensive chemical resistance. aquatherm red pipe transition connections and elements with brass inserts are not suitable for all media. The compatibility should be asked at aquatherm with media deviating from water. Please use the “Enquiry for the chemical resistance” on page 66.

**Pipe friction loss**

The pressure loss caused by friction is to be calculated hydraulically with the Hazen-Williams-formula.

The value to be used for C is 150, applicable for calculations of sprinkler installations and water supply.

**Equivalent lengths for the aquatherm red pipe sprinkler pipe system**

The equivalent lengths of transition pieces, threaded connexions and tees (flow direction: straight) can be edequated with the socket values.

Pipe dimension											
Pipe series	SDR 7,4	SDR 7,4	SDR 7,4	SDR 7,4	SDR 7,4	SDR 7,4	SDR 7,4	SDR 7,4	SDR 7,4	SDR 7,4	SDR 11
Nominal Diameter	DN15	DN20	DN25	DN32	DN40	DN50	-	DN65	DN80	-	DN125
Outer diameter aquatherm red pipe	20,0 mm	25,0 mm	32,0 mm	40,0 mm	50,0 mm	63,0 mm	75,0 mm	90,0 mm	110,0 mm	125,0 mm	160,0 mm
Article	Equivalent pipe length in (m)										
Socket	0,17	0,22	0,30	0,40	0,52	0,70	0,86	1,07	1,36	1,58	2,44
Reduction of 1 dimension	0,20	0,27	0,37	0,48	0,63	0,83	1,03	1,28	1,63	1,90	2,93
Reduction of 2 dimensions	0,27	0,36	0,49	0,64	0,84	1,11	1,37	1,71	2,17	2,53	3,91
Elbow < 90°–45°	0,51	0,67	0,91	1,20	1,57	2,09	2,57	3,20	4,07	4,74	7,33
Elbow < 45°	0,25	0,33	0,46	0,60	0,78	1,04	1,28	1,60	2,03	2,37	3,66
Standard tee or cross flow direction branch	0,74	0,98	1,34	1,76	2,30	3,06	3,76	4,70	5,96	6,96	10,75

**PIPE, FITTINGS**

**Material:** PP-R FS  
**Pipe series:** SDR 7,4  
**Packing Unit:** straight length à 6 m  
**Colour:** red/4 green stripes

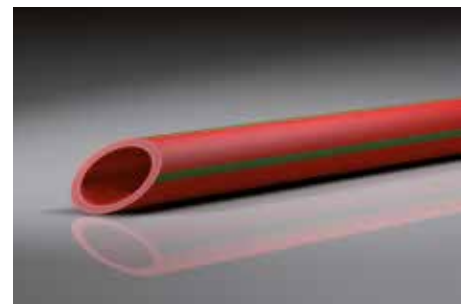
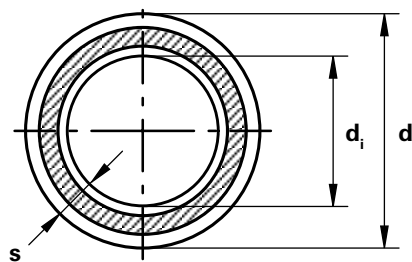

**aquatherm red pipe PIPE SDR 7,4 / B1**

Art. no.	Dimension mm	PU m/pc	Price € m/pc	Diameter d [mm]	Wall thickness s [mm]	Internal diameter d <sub>i</sub> [mm]	Water content [l/m]	Weight [kg/m]
4170708	20 x 2,8	120		20	2,8	14,4	0,163	0,160
4170710	25 x 3,5	120		25	3,5	18	0,254	0,249
4170712	32 x 4,4	60		32	4,4	23,2	0,423	0,400
4170714	40 x 5,5	60		40	5,5	29	0,660	0,621
4170716	50 x 6,9	30		50	6,9	36,2	1,029	0,968
4170718	63 x 8,6	30		63	8,6	45,8	1,647	1,521
4170720	75 x 10,3	18		75	10,3	54,4	2,323	2,165
4170722	90 x 12,3	18		90	12,3	65,4	3,358	3,101
4170724	110 x 15,1	12		110	15,1	79,8	4,999	4,642
4170726	125 x 17,1	6		125	17,1	90,8	6,472	5,974

**aquatherm red pipe PIPE SDR 11 / B1**

Art. no.	Dimension mm	PU m/pc	Price € m/pc	Diameter d [mm]	Wall thickness s [mm]	Internal diameter d <sub>i</sub> [mm]	Water content [l/m]	Weight [kg/m]
4170130	160 x 14,6	5.8		160	14,6	130,8	15,792	6,940

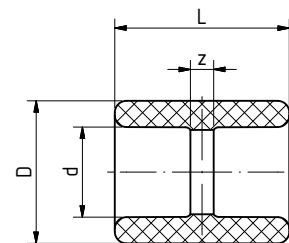
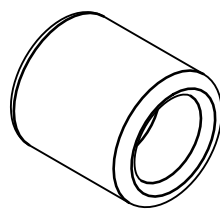

**aquatherm red pipe SOCKET / B1**

Art. no.	Dimension mm	PU m/pc	Price € m/pc	d	L	z	D	Weight [kg/m]
4111008	20	10		20	32	3	29,5	0,011
4111010	25	10		25	35	3	34	0,014
4111012	32	5		32	40,5	4,5	43	0,027
4111014	40	5		40	47,5	6,5	52	0,044
4111016	50	5		50	53	6	68	0,086
4111018	63	1		63	60,5	5,5	84	0,145
4111020	75	1		75	66,5	6,5	100	0,233
4111022	90	1		90	72,5	6,5	120	0,353
4111024	110	1		110	82	8	147	0,606
4111026	125	1		125	92	12	167	0,819

Art. no.=article number, PU=Packing unit, d=Diameter (mm), s=wall thickness (mm), d<sub>i</sub>=internal diameter (mm), f=female thread, m=male thread

FITTINGS

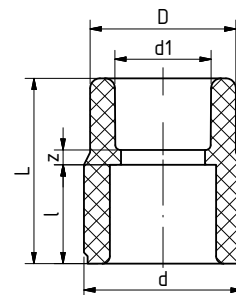
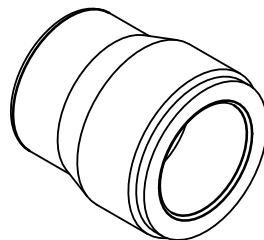

**aquatherm red pipe REDUCER / B1**

SDR	Art. no.	Dimension mm	PU m/pc	Price € m/pc	d	d1	L	l	z	D	Weight
7,4	socket welding										
	4111112	25/20	10		25	20	38,5	16	8	29,5	0,012
	4111116	32/25	5		32	25	38	18	4	34	0,016
	4111122	40/32	5		40	32	50	20,5	11,5	43	0,033
	4111124	50/20	5		50	20	55	23,5	12,5	43	0,054
	4111128	50/32	5		50	32	54	23,5	9	52	0,059
	4111130	50/40	5		50	40	53	23,5	12,5	68	0,122
	4111131	63/20	1		63	20	65	27,5	13,5	84	0,173
	4111138	63/50	1		63	50	63,5	27,5	17,5	84	0,232
	4111140	75/50	1		75	50	63	30	18,5	100	0,281
	4111142	75/63	1		75	63	71	30	29	120	0,564
	4111152	90/63	1		90	63	78	33	26	120	0,831
	4111153	90/75	1		90	75	81,5	33	35	147	0,811
	4111155	110/63	1		110	63	86	37	17	29,5	0,045
	4111159	110/90	1		110	90	99	37	23	29,5	0,081
4111163	125/90	1		125	90	99	40	9,5	68	0,143	
4111165	125/110	1		125	110	112	40	21,5	84	0,363	

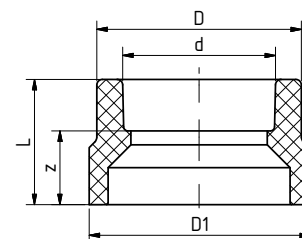
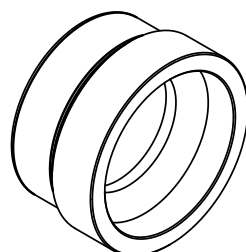

**aquatherm red pipe REDUCER / B1**

SDR	Art. no.	Dimension mm	PU m/pc	Price € m/pc	D1	d	L	z	D	Weight	
11	butt welding										
	4111175	160/110	1		160	110	90	53	147	0,681	
	4111177	160/125	1		160	125	90	50	167	0,729	

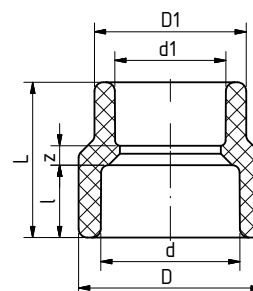
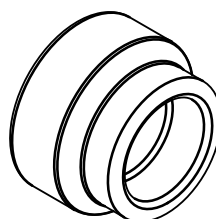

**aquatherm red pipe REDUCING SOCKET / B1**

female/female

Art. no.	Dimension mm	PU m/pc	Price € m/pc	d	d1	L	l	z	D	D1	Weight
4111238	63/50	1		63	50	56	27,5	5	84	68	0,126
4111242	75/63	1		75	63	62,5	30	5	100	84	0,191
4111253	90/75	1		90	75	69	33	6	120	100	0,297

FITTINGS

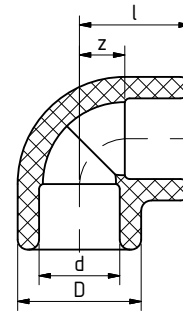
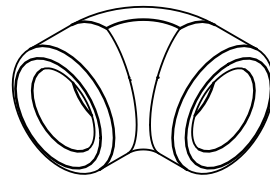

**aquatherm red pipe ELBOW 90°/ B1**

SDR	Art. no.	Dimension mm	PU m/pc	Price € m/pc	D	z	l	D	Weight
7,4	socket welding								
	4112108	20	10		20	11	25,5	27	0,013
	4112110	25	10		25	13,5	29,5	34	0,023
	4112112	32	5		32	17	35	43	0,043
	4112114	40	5		40	21	41,5	52	0,071
	4112116	50	5		50	26	49,5	68	0,158
	4112118	63	1		63	32,5	60	84	0,276
	4112120	75	1		75	38,5	68,5	100	0,446
	4112122	90	1		90	46	79	120	0,798
	4112124	110	1		110	56	93	147	1,323
4112126	125	1		125	76,5	116,5	167	2,026	

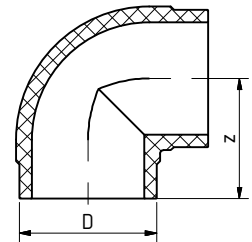
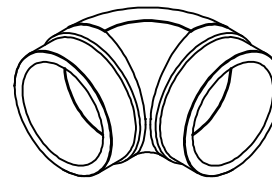

**aquatherm red pipe ELBOW 90°/ B1**

SDR	Art. no.	Dimension mm	PU m/pc	Price € m/pc	D	z	Weight
11	butt welding						
	4112131	160	1		160	145	1,976

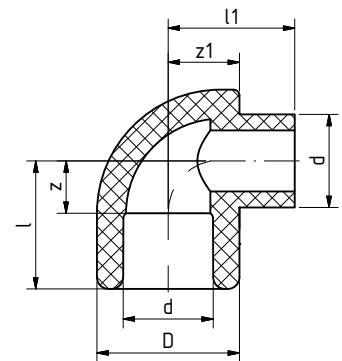
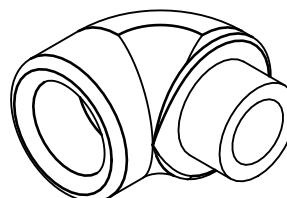

**aquatherm red pipe ELBOW 90°/ B1**

female/male

Art. no.	Dimension mm	PU m/pc	Price € m/pc	d	z	l	D	l1	z1	Weight
4112308	20	10		20	11	25,5	29,5	25,5	15	0,017
4112310	25	10		25	13,5	29,5	34	29,5	17	0,024
4112312	32	5		32	17	35	43	39	21,5	0,049
4112314	40	5		40	21	41,5	52	45,5	26	0,081



FITTINGS

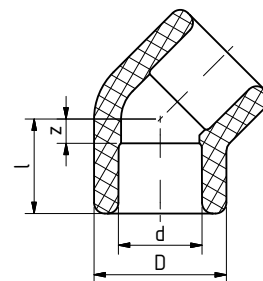
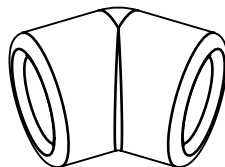

**aquatherm red pipe ELBOW 45° / B1**

SDR	Art. no.	Dimension mm	PU m/pc	Price € m/pc	d	z	l	D	Weight
7.4	socket welding								
	4112508	20	10		20	5	19,5	29,5	0,015
	4112510	25	10		25	6	22	34	0,019
	4112512	32	5		32	7,5	25,5	43	0,035
	4112514	40	5		40	9,5	30	52	0,057
	4112516	50	5		50	11,5	35	68	0,112
	4112518	63	1		63	14	41,5	84	0,233
	4112520	75	1		75	16,5	46,5	100	0,353
	4112522	90	1		90	19,5	52,5	120	0,571
	4112524	110	1		110	23,5	60,5	147	0,993
4112526	125	1		125	27	67	167	1,281	

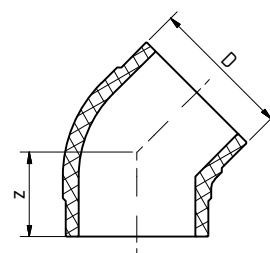
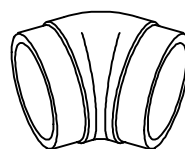

**aquatherm red pipe ELBOW 45° / B1**

SDR	Art. no.	Dimension mm	PU m/pc	Price € m/pc	z	D	Weight
11	butt welding						
	4112531	160	1		95	160	1,463

**Advice: Special elbows in diverse degree sizes on request**

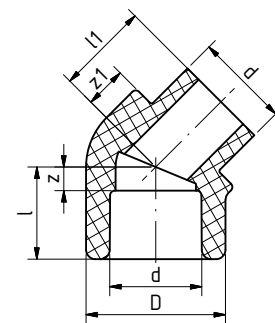
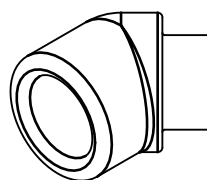

**aquatherm red pipe ELBOW 45° / B1**

female/male

Art. no.	Dimension mm	PU m/pc	Price € m/pc	d	z	l	D	l1	z1	Weight
4112708	20	10		20	5	19,5	29,5	19,5	9	0,014
4112710	25	10		25	6	22	34	22	8,5	0,018
4112712	32	5		32	7,5	25,5	43	28,5	11,5	0,036
4112714	40	5		40	9,5	30	52	30,5	13,5	0,059



FITTINGS

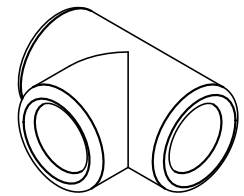
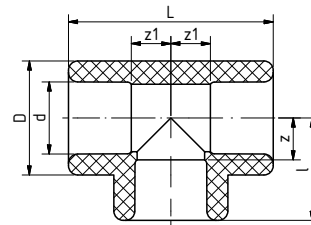

**aquatherm red pipe TEE / B1**

SDR	Art. no.	Dimension mm	PU m/pc	Price € m/pc	d	D	l	z	L	z1	Weight
7,4	socket welding										
	4113108	20	10		20	27	25,5	11	51	11	0,022
	4113110	25	10		25	34	30,5	14,5	62	15	0,033
	4113112	32	5		32	43	33,5	15,5	70	17	0,053
	4113114	40	5		40	52	40,5	20	81	20	0,093
	4113116	50	5		50	68	49,5	26	99	26	0,200
	4113118	63	1		63	84	60	32,5	120	32,5	0,377
	4113120	75	1		75	100	68,5	38,5	137	38,5	0,537
	4113122	90	1		90	120	80	47	158	46	0,986
	4113124	110	1		110	147	93	56	186	56	1,632
4113126	125	1		125	167	116,5	76,5	233	76,5	2,693	

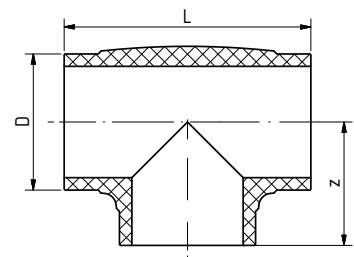
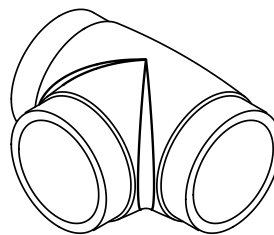

**aquatherm red pipe TEE / B1**

SDR	Art. no.	Dimension mm	PU m/pc	Price € m/pc	D	z	L	Weight
11	butt welding							
	4113131	160	1		160	145	290	2,838

FITTINGS

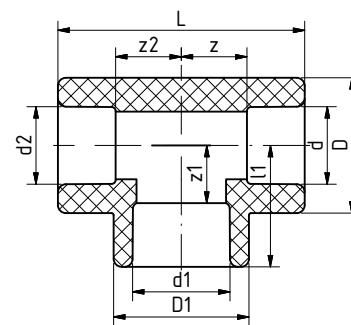
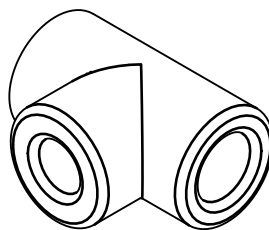

**aquatherm red pipe REDUCING TEE / B1**

SDR	Art. no.	Dimension mm	PU m/pc	Price € m/pc	d	z	D	d1	l1	z1	D1	d2	L	z2	Weight
7.4	socket welding														
	4113511	20x25x20	10		20	16,5	34	25	30,5	14,5	34	20	62	16,5	0,040
	4113520	25x20x20	10		25	15	34	20	30,5	16	34	20	62	16,5	0,039
	4113522	25x20x25	10		25	15	34	20	30,5	16	34	25	62	15	0,036
	4113532	32x20x20	5		32	18,75	43	20	37	22,5	43	20	73,5	22,25	0,084
	4113534	32x20x32	5		32	17	43	20	31	16,5	29,5	32	70	17	0,055
	4113540	32x25x32	5		32	17	43	25	32	16	34	32	70	17	0,066
	4113544	40x25x40	5		40	21	52	25	36	20	34	40	83	21	0,091
	4113546	40x32x40	5		40	21,5	52	32	40,5	22,5	52	40	84	21,5	0,106
	4113550	50x32x50	5		50	26	68	32	44,5	26,5	43	50	99	26	0,174
	4113551	50x40x50	5		50	26	68	40	49,5	29	68	50	99	26	0,221
	4113556	63x32x63	1		63	32,5	84	32	53,5	35,5	52	63	120	32,5	0,355
	4113558	63x40x63	1		63	32,5	84	40	53,5	33	52	63	120	32,5	0,341
	4113560	63x50x63	1		63	32,5	84	50	60	36,5	68	63	120	32,5	0,411
	4113566	75x40x75	1		75	38,5	100	40	59	38,5	52	75	137	38,5	0,494
	4113568	75x50x75	1		75	38,5	100	50	66	42,5	84	75	137	38,5	0,540
	4113570	75x63x75	1		75	38,5	100	63	66	38,5	84	75	137	38,5	0,507
	4113578	90x40x90	1		90	46	120	40	65	44,5	52	90	158	46	0,986
	4113580	90x50x90	1		90	46	120	50	75	51,5	84	90	158	46	0,976
	4113582	90x63x90	1		90	46	120	63	75	47,5	84	90	158	46	0,969
	4113584	90x75x90	1		90	46	120	75	81	51	120	90	158	46	0,997
	4113586	110x63x110	1		110	56	147	63	87,5	60	100	110	186	56	1,691
	4113588	110x75x110	1		110	56	147	75	87,5	57,5	100	110	186	56	1,634
4113590	110x90x110	1		110	56	147	90	89	56	120	110	186	56	1,569	
4113592	125x75x125	1		125	76,5	167	75	106,5	76,5	100	125	233	76,5	2,475	
4113594	125x90x125	1		125	76,5	167	90	109,5	76,5	120	125	233	76,5	2,542	
4113596	125x110x125	1		125	76,5	167	110	113,5	76,5	147	125	233	76,5	2,606	

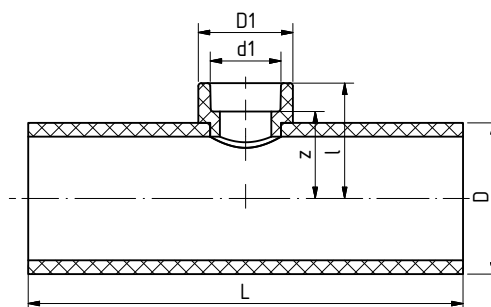
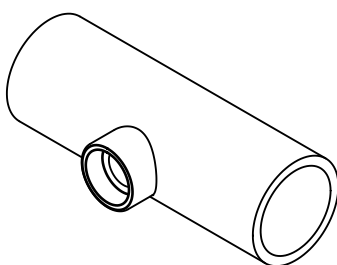

**aquatherm red pipe REDUCING TEE / B1**

SDR	Art. no.	Dimension mm	PU m/pc	Price € m/pc	D	d1	D1	L	l	z	Weight
11	butt welding										
	4113601	160x75x160	1		160	75	100	460	122	92	3,397
	4113603	160x90x160	1		160	90	120	460	125	92	3,517

FITTINGS

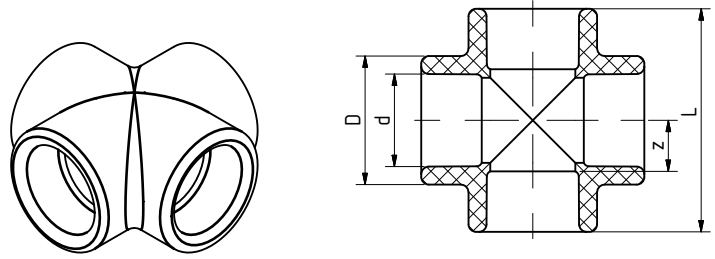

**aquatherm red pipe CROSS / B1**

Art. no.	Dimension mm	PU m/pc	Price € m/pc	d	z	L	D	Weight
4113712	32	5		32	17	70	43	0,064
4113714	40	5		40	21	83	52	0,101

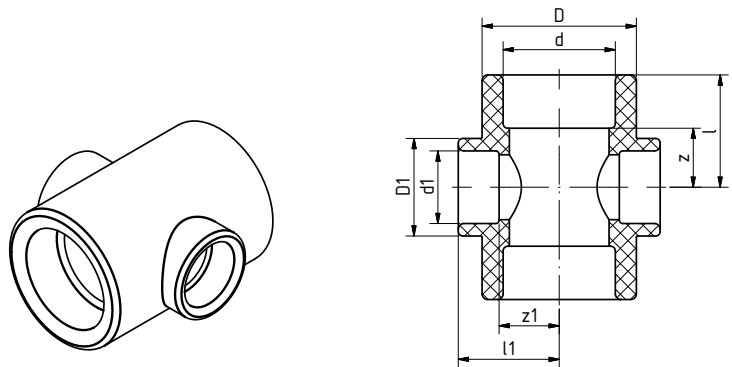

**aquatherm red pipe REDUCING TEE / B1**

Art. no.	Dimension mm	PU m/pc	Price € m/pc	d1	z1	D1	l1	d	z	D	l	Weight
4113750	50/32	1		32	26,5	43	44,5	50	26	68	49,5	0,180
4113756	63/32	1		32	35,5	52	53,5	63	32,5	84	60	0,350
4113758	63/40	1		40	33	52	53,5	63	32,5	84	60	0,328
4113764	75/32	1		32	41	52	59	75	38,5	100	68,5	0,509
4113766	75/40	1		40	38,5	52	59	75	38,5	100	68,5	0,499
4113768	75/50	1		50	42,5	68	66	75	38,5	100	68,5	0,528
4113776	90/50	1		50	51,5	68	75	90	35,5	120	68,5	0,762

FITTINGS

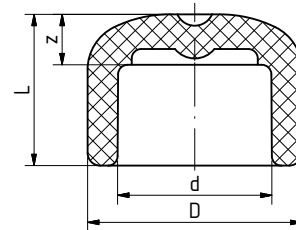
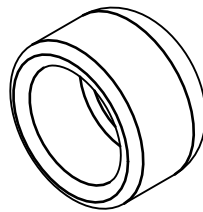

**aquatherm red pipe END CAP / B1**

SDR	Art. no.	Dimension mm	PU m/pc	Price € m/pc	d	L	z	D	Weight
7,4	socket welding								
	4114108	20	10		20	24	9,5	29,5	0,009
	4114110	25	10		25	24	8	34	0,011
	4114112	32	5		32	29	11	43	0,044
	4114114	40	5		40	38	17,5	52	0,042
	4114116	50	5		50	44,5	21	68	0,082
	4114118	63	1		63	52	24,5	84	0,153
	4114120	75	1		75	58,5	28,5	100	0,245
	4114122	90	1		90	67,5	34,5	120	0,377
	4114124	110	1		110	65	28	147	0,648
4114126	125	1		125	82	42	167	0,872	

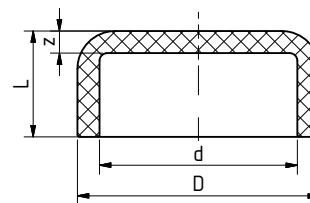
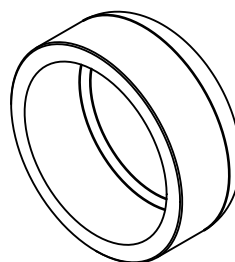

**aquatherm red pipe END CAP / B1**

SDR	Art. no.	Dimension mm	PU m/pc	Price € m/pc	D	L	z	d	Weight
11	butt welding								
	4114131	160	1		160	0,00	14,6	131	0,787

FITTINGS

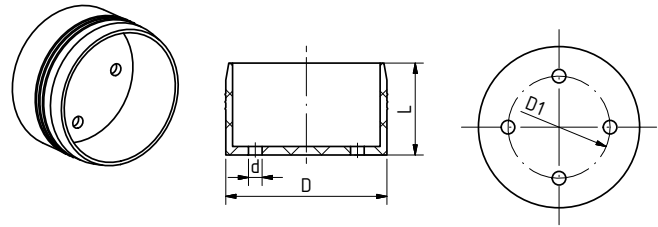

**aquatherm red pipe** BASE PART FOR SPRINKLER OUTLET

Art. no.		PU m/St	Price € m/pc	D	D1	d	L	Weight
4114180	for visible sprinkler	25		47,35	30	4	27	0,013

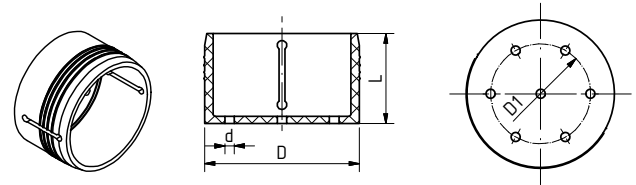

**aquatherm red pipe** BASE PART FOR SPRINKLER OUTLET

Art. no.		PU m/pc	Price € m/pc	D	D1	d	L	Weight
4114190	for covered sprinkler	25		65	44	4	38	0,034

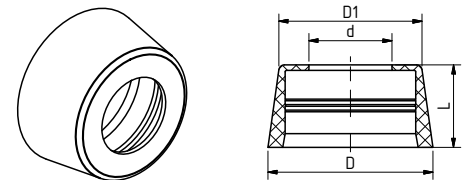

**aquatherm red pipe** UPPER PART FOR SPRINKLER OUTLET  
for visible sprinkler

Art. no.	Dimension	PU m/pc	Price € m/pc	D	D1	d	L	Weight
4114181	1/2"	25		60	51,4	23,2	30	0,022
4114182	3/4"	25		60	51,6	30,2	30	0,022
4114183	1"	25		60	51,6	35,2	30	0,021

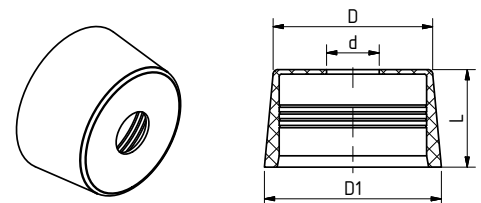

**aquatherm red pipe** UPPER PART FOR SPRINKLER OUTLET  
for covered sprinkler

Art. no.	Dimension	PU m/pc	Price € m/pc	D	D1	d	L	Weight
4114191	1/2"	25		70	78	23,2	43	0,057
4114192	3/4"	25		70	78	30,2	43	0,057
4114193	1"	25		70	78	35,2	43	0,056

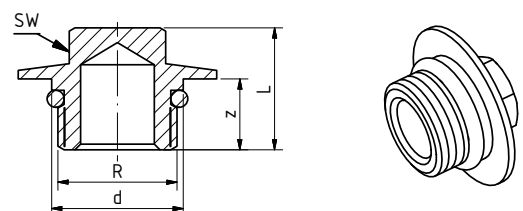

**aquatherm red pipe** PLUG FOR SPRINKLER OUTLET

Art. no.	Dimension	PU m/pc	Price € m/pc	R	d	L	z	SW	Weight
4114185	1/2"	25		1/2"	23	21,5	12,5	15	0,043
4114186	3/4"	25		3/4"	30	23	12,5	17	0,058
4114187	1"	25		1"	35	24	13	17	0,076

FITTINGS

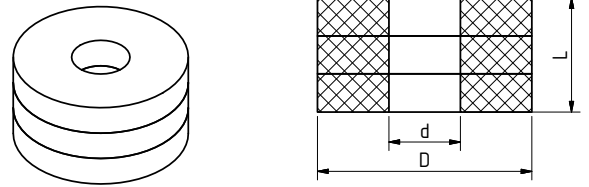

**aquatherm red pipe TEMPORARY PLUG FOR PLASTER WORKS**

made of PE foam

Art. no.	Dimension	PU m/pc	Price € m/pc	d	D	L	Weight
4114178	for 4114181, -82, -83	50		20	75,5	42	0,004
4114179	for 4114191, -92, -93	50		20	60	32	0,003

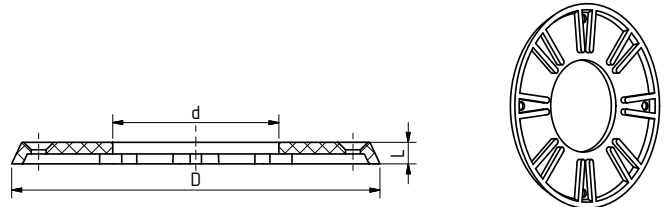

**aquatherm red pipe SPRINKLER OUTLET**

Art. no.	Dimension	PU m/pc	Price € m/pc	D	d	L	Weight
4114200	1 1/4"	10		100,1	44,1	6,5	0,028
4114201	1 1/2"	10		111,1	50,1	6,5	0,034
4114202	2"	10		126,1	61,1	6,5	0,043

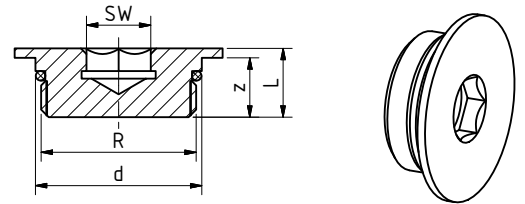

**aquatherm red pipe PLUG FOR SPRINKLER OUTLET**

Art. no.	Dimension	PU m/pc	Price € m/pc	d	R	L	z	SW	Weight
4114206	Plug for sprinkler outlet 1 1/4"	10		44	1 1/4"	18,2	15,7	17	0,203
4114207	Plug for sprinkler outlet 1 1/2"	10		50	1 1/2"	18	15,5	17	0,260
4114208	Plug for sprinkler outlet 2"	10		61	2"	20	17,5	17	0,443

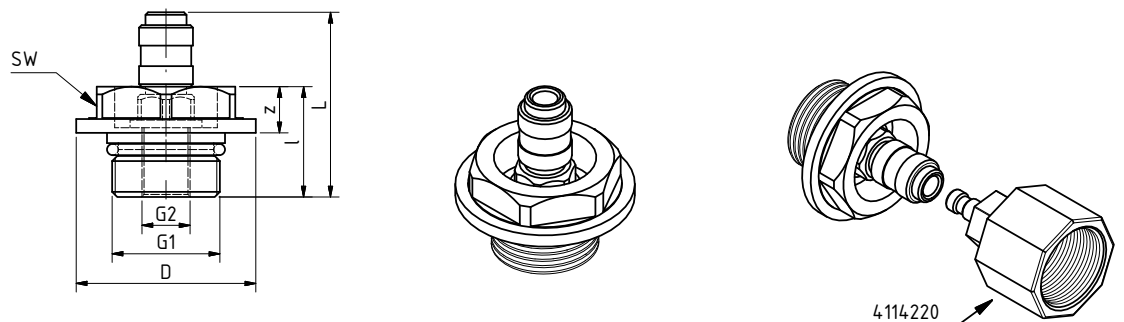

**aquatherm red pipe PLUG FOR PRESSURE TEST**

Art. no.	Dimension	PU m/pc	Price € m/pc	D	G1	G2	z	l	L	SW	Weight
4114212	thread 1/2"	10		35	1/2"	1/8"	9	21,5	36	27	0,072
4114213	thread 3/4"	10		35	3/4"	1/8"	9	21,5	36	27	0,093
4114214	thread 1"	10		40	1"	1/8"	8,5	21,5	36	27	0,126

**aquatherm red pipe COUPLING PLUG 1/2"**

4114220	1/2" for Art-. No. 4114212, -13, -14	1									0,040
---------	--------------------------------------	---	--	--	--	--	--	--	--	--	-------

**FITTINGS**

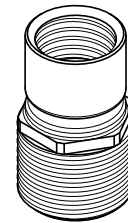
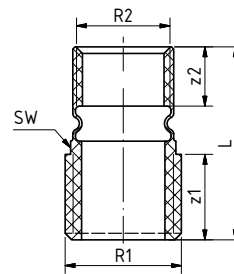

**NEW aquatherm red pipe COMPENSATING JOINT**

Art. no.	Dimension	PU m/pc	Price € m/pc	R1	z1	R2	z2	L	SW	Weight
4114230	3/4"mx3/8"f	10		3/4"	17,5	3/8"	15,5	44	24	0,054
4114232	3/4"mx1/2"f	10		3/4"	19,5	1/2"	13,5	44	24	0,043
4114234	1"mx1"f	10		1"	17	1"	17	45	36	0,067
4114236	1"mx1/2"f	10		1"	19,5	1/2"	13,5	44	30	0,052

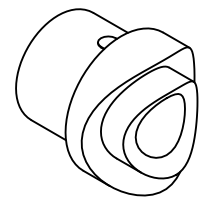
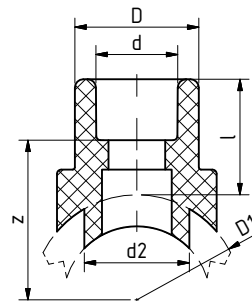

**aquatherm red pipe WELD-IN SADDLE**

SDR	Art. no.	Dimension mm	PU m/pc	Price € m/pc	D1	d	d2	l	z	D	Weight
7,4	socket welding										
	4115156	40/20	5		40	20	25	27	32,5	29,5	0,016
	4115158	40/25	5		40	25	25	28,5	32,5	34	0,017
	4115160	50/20	5		50	20	25	27,5	38	29,5	0,018
	4115162	50/25	5		50	25	25	28,5	37,5	34	0,019
	4115164	63/20	5		63	20	25	27,5	44,5	29,5	0,017
	4115166	63/25	5		63	25	25	28,5	44	34	0,019
	4115168	63/32	5		63	32	32	30	43,5	43	0,028
	4115170	75/20	5		75	20	25	27,5	50,5	29,5	0,018
	4115172	75/25	5		75	25	25	28,5	50	34	0,019
	4115174	75/32	5		75	32	32	30	49,5	43	0,028
	4115175	75/40	5		75	40	40	34	51	52	0,049
	4115176	90/20	5		90	20	25	27,5	58	29,5	0,018
	4115178	90/25	5		90	25	25	28,5	57,50	34	0,019
	4115180	90/32	5		90	32	32	30	57	43	0,029
	4115181	90/40	5		90	40	40	34	58,5	52	0,048
	4115182	110/20	5		110	20	25	27,5	68	29,5	0,019
	4115184	110/25	5		110	25	25	28,5	67,5	34	0,020
	4115186	110/32	5		110	32	32	30	67	43	0,030
	4115188	110/40	5		110	40	40	34	68,5	52	0,050
4115189	110/50	5		110	50	50	34	65,5	68	0,030	
4115190	125/20	5		125	20	25	27,5	75,50	29,5	0,019	
4115192	125/25	5		125	25	25	28,5	75	34	0,020	
4115194	125/32	5		125	32	32	30	74,5	43	0,029	
4115196	125/40	5		125	40	40	34	76	52	0,050	
4115197	125/50	5		125	50	50	34	73	68	0,030	
4115198	125/63	5		125	63	63	38	73	84	0,030	
NEW NEW 11	butt welding										
	4115214	160/50	5		160	50	50	34	0,00	68	0,054
	4115216	160/63	5		160	63	63	38	0,00	84	0,054
	4115218	160/75	5		160	75	75	42	92	100	0,248
	4115220	160/90	5		160	90	90	45	92	120	0,368

With weld-on surface and weld-in socket to be fused with the inner wall of the pipe.

The required tools for the fusion of **aquatherm red pipe** weld-in saddles are listed on page 34:

**aquatherm red pipe** weld-in saddle tools Art. no. 50614–50658 **aquatherm** drill Art. no. 50940–50952

FITTINGS

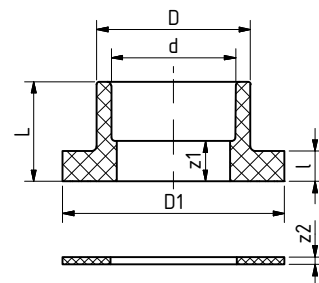
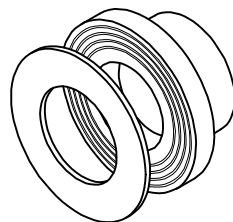

**aquatherm red pipe WELDABLE FLANGE ADAPTER / B1**  
with joint ring

SDR	Art. no.	Dimension mm	PU m/pc	Price € m/pc	d	L	z1	D	D1	l	z2	Weight
7,4	socket welding											
	4115512	32	1		32	34	16	41	68	10	3	0,053
	4115514	40	1		40	35,5	15	50	78	11	3	0,071
	4115516	50	1		50	39,5	17	61	88	12	3	0,095
	4115518	63	1		63	43,5	16	76	102	14	3	0,130
	4115520	75	1		75	46	16	90	122	16	3	0,191
	4115522	90	1		90	50	17	108	138	17	3	0,258
	4115524	110	1		110	55,5	18,5	131	158	18,5	3	0,329
4115527	125	1		125	63	23	165	188	20	3	0,724	

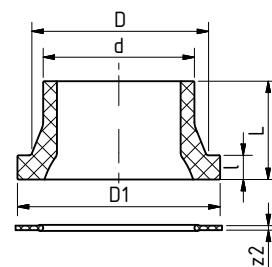
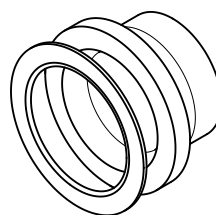

**aquatherm red pipe WELDABLE FLANGE ADAPTER / B1**  
with joint ring

SDR	Art. no.	Dimension mm	PU m/pc	Price € m/pc	d	L	z1	D	D1	l	z2	Weight
11	butt welding											
	4115531	160	1		160	93	3,00	175	212	25	3	1,065

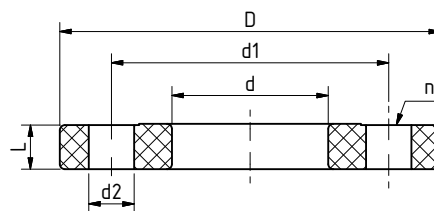
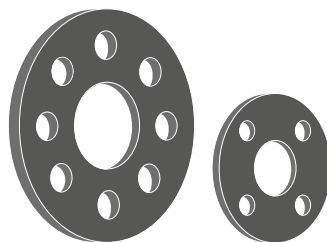

**aquatherm red pipe STEEL FLANGE**

Art. no.	Dimension mm	PU m/pc	Price € m/pc	d	D	d1	d2	L	n	Weight
4115712	32	1		42	116	85	14	15,5	4	1,046
4115714	40	1		51	141	100	18	17,5	4	1,589
4115716	50	0		62	151	110	18	17,5	4	1,675
4115718	63	1		78	166	125	18	19	4	2,016
4115720	75	1		92	186	145	18	19	4	2,437
4115722	90	1		110	201	160	18	21	8	2,699
4115724	110	1		133	221	180	18	22	8	3,084
4115726	125	1		167	251	210	18	26	8	3,654
4115730	160	1		178	286	240	22	27	8	5,106



**FITTINGS**

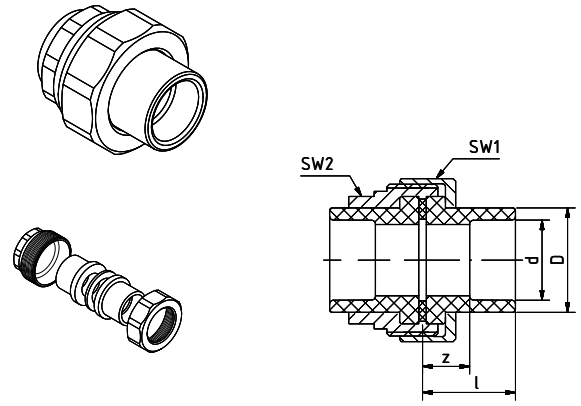

**aquatherm red pipe COUPLING SCREW / B1**

Art. no.	Dimension mm	PU m/pc	Price € m/pc	d	l	z	D	SW1	SW2	Weight
4115812	32	1		32	36,5	18,5	41	64	50	0,479
4115814	40	1		40	38	17,5	50	80	60	0,841
4115816	50	1		50	41	17,5	61	86	70	0,821
4115818	63	1		63	45	17,5	76	108	90	1,498
4115820	75	1		75	47,5	17,5	90	128	104	1,998

Incl. 2 flange adapters with gasket

**TRANSITION PIECE**

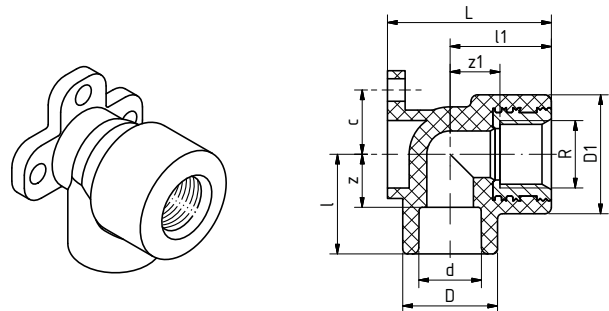

**aquatherm red pipe BACK PLATE ELBOW / B1**

Art. no.	Dimension	PU m/pc	Price € m/pc	d	l	z	D	l1	z1	D1	L	c	R	Weight
4120108	20 mm x 1/2"	10		20	31	16,5	29,5	31,5	18,5	37	51	20	1/2"	0,077
4120112	25 mm x 3/4"	10		25	37	21	34	37	24	44	54	-	3/4"	0,111

**TRANSITION PIECE**

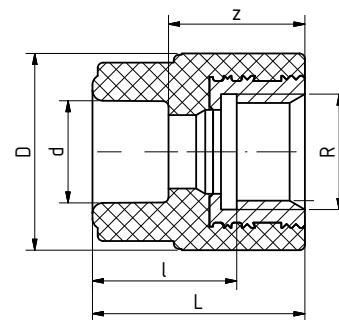
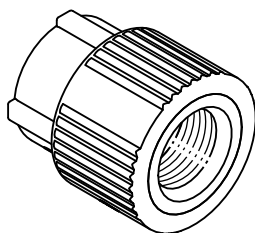

**aquatherm red pipe TRANSITION PIECE / B1**

for the connection to sprinkler outlets  
round

Art. no.	Dimension	PU m/pc	Price € m/pc	d	l	z	D	L	R	Weight
4121008	20 mm x 1/2" f	10		20	27,5	26	37,5	40,5	1/2"	0,064
4121011	25 mm x 1/2" f	10		25	29,5	26,5	38,5	42,5	1/2"	0,065
4121012	25 mm x 3/4" f	10		25	27,5	24,5	43,5	40,5	3/4"	0,087
4121013	32 mm x 3/4" f	5		32	30,5	25,5	43,5	43,5	3/4"	0,092
4121014	32 mm x 1/2" f	5		32	28	23	37	41	1/2"	0,076
4121016	40 mm x 1/2" f	5		40	32,5	25	37	45,5	1/2"	0,078
4121017	40 mm x 3/4" f	5		40	33	25,5	50	46	3/4"	0,105

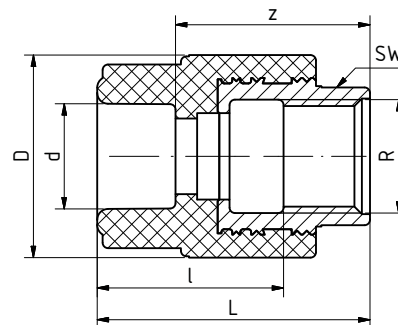
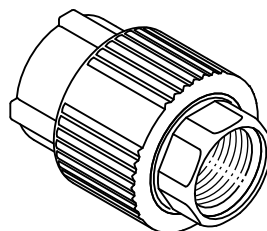

**aquatherm red pipe TRANSITION PIECE / B1**

with hexagon (\*suitable for the connection to sprinkler outlets)

Art. no.	Dimension	PU m/pc	Price € m/pc	d	l	z	D	L	R	SW	Weight
4121108	20 mm x 1/2" f	10		20	34,5	36	38,5	50,5	1/2"	24	0,088
4121110	20 mm x 3/4" f	10		20	29	35,5	43,5	50	3/4"	31	0,100
4121111	25 mm x 1/2" f	10		25	36	36	38,5	52	1/2"	24	0,089
4121112	25 mm x 3/4" f	10		25	29	34	43,5	50	3/4"	31	0,109
4121113	32 mm x 3/4" f	5		32	32	35	43,5	53	3/4"	31	0,104
4121114*	32 mm x 1" f	5		32	37,5	41,5	60	59,5	1"	39	0,239
4121115*	40 mm x 1" f	5		40	40	41,5	60	62	1"	39	0,227
4121116	40 mm x 1 1/4" f	5		40	40	42,5	74	63	1 1/4"	50	0,385
4121117	50 mm x 1 1/4" f	5		50	43	42,5	74	66	1 1/4"	50	0,404
4121118	50 mm x 1 1/2" f	5		50	45	43,5	84	67	1 1/2"	55	0,445
4121119	63 mm x 1 1/2" f	1		63	51,5	46	84	73,5	1 1/2"	55	0,479
4121120	63 mm x 2" f	1		63	50	49,5	101	76	2"	67	0,662
4121122	75 mm x 2" f	1		75	51	47	100	77	2"	67	0,671
4121153	32 mm x 1/2" f	5		32	37	35	37,5	53	1/2"	24	0,091
4121154	40 mm x 1/2" f	5		40	38	33,5	40	54	1/2"	24	0,094

**TRANSITION PIECE**

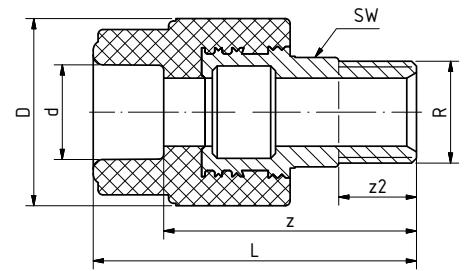
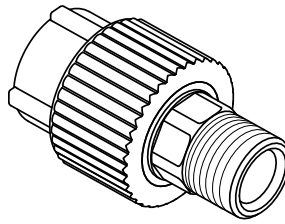

**aquatherm red pipe TRANSITION PIECE / B1**  
with hexagon

Art. no.	Dimension	PU m/pc	Price € m/pc	d	L	z	D	R	SW	z2	Weight
4121308	20 mm x 1/2" m	10		20	66,5	52	38,5	1/2"	22	16	0,119
4121310	20 mm x 3/4" m	10		20	67,5	53	38,5	3/4"	24	18	0,103
4121311	25 mm x 1/2" m	10		25	68	52	38,5	1/2"	21	16	0,119
4121312	25 mm x 3/4" m	10		25	67,5	51,5	38,5	3/4"	24	18	0,128
4121313	32 mm x 3/4" m	5		32	69,5	51,5	38,5	3/4"	24	17	0,135
4121314	32 mm x 1" m	5		32	78,5	60,5	53	1"	32	20	0,244
4121316	32 mm x 1 1/4" m	5		32	81	63	68	1 1/4"	41	21	0,324
4121317	40 mm x 1" m	5		40	81	60,5	52	1"	32	20	0,251
4121318	40 mm x 1 1/4" m	5		40	84,5	64	68	1 1/4"	41	21	0,362
4121319	50 mm x 1 1/4" m	5		50	85,5	62	68	1 1/4"	41	21	0,389
4121320	50 mm x 1 1/2" m	5		50	88,5	65	74	1 1/2"	46	22	0,480
4121321	63 mm x 1 1/2" m	1		63	94,5	67	72,5	1 1/2"	46	22	0,523
4121322	63 mm x 2" m	1		63	102,5	75	84	2"	50	23,5	0,708
4121323	75 mm x 2" m	1		75	102	72	84	2"	50	23,5	0,753
4121324	75 mm x 2 1/2" m	1		75	105	75	100	2 1/2"	65	26,7	1,024
4121325	90 mm x 3" m	1		90	121	88	120	3"	85	30	1,488
4121327	110 mm x 4" m	1		110	148	111	147	4"	105	39	2,816

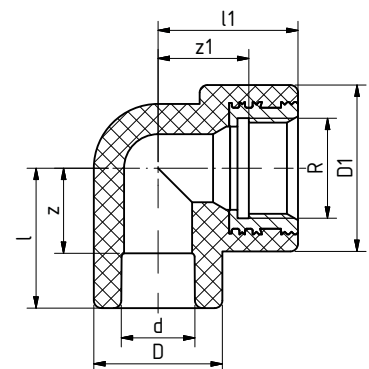
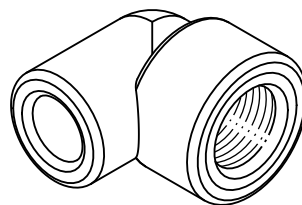

**aquatherm red pipe TRANSITION ELBOW / B1**

Art. no.	Dimension	PU m/pc	Price € m/pc	d	l	z	D	l1	z1	D1	R	Weight
4123008	20 mm x 3/4" f	10		20	37	22,5	34	37	24	44	3/4"	0,107
4123010	20 mm x 1/2" f	10		20	31	16,5	29,5	31,5	18,5	37	1/2"	0,084
4123012	25 mm x 3/4" f	10		25	37	21	34	37	24	44	3/4"	0,087
4123014	25 mm x 1/2" f	10		25	33,5	17,5	34	31,5	18,5	37	1/2"	0,079
4123015	32 mm x 1/2" f	10		32	35	17	43	37	24	37	1/2"	0,088
4123016	32 mm x 3/4" f	5		32	27,5	9,5	43	51	38	44	3/4"	0,112
4123018	32 mm x 1" f	5		32	34	16	43	66,5	44,5	60,5	1"	0,265
4123020	40 mm x 1/2" f	5		40	41,75	21,25	52	40	27	37	1/2"	0,116
4123022	40 mm x 1" f	5		40	41,5	21	52	56	34	60	1"	0,265

**TRANSITION PIECE**

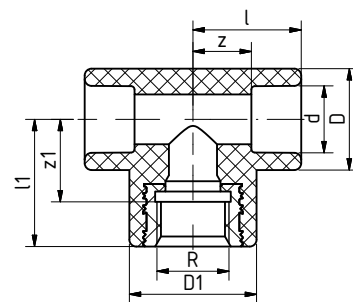
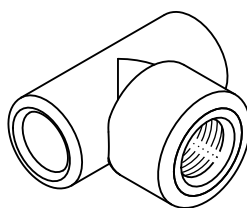

**aquatherm red pipe THREADED BRANCH TEE / B1**

Art. no.	Dimension	PU m/pc	Price € m/pc	d	l	z	D	l1	z1	D1	R	SW	Weight
4125006	20 x 1/2" f x 20 mm	10		20	31,5	17	29,5	37	24	37	1/2"	-	0,083
4125008	20 x 3/4" f x 20 mm	10		20	37	22,5	34	37	24	44	3/4"	-	0,121
4125010	25 x 1/2" f x 25 mm	10		25	34,5	18,5	34	38	25	37	1/2"	-	0,088
4125012	25 x 3/4" f x 25 mm	10		25	37	21	34	37	24	44	3/4"	-	0,115
4125013	32 x 1/2" f x 32 mm	5		32	35	17	43	37	24	37	1/2"	-	0,113
4125014	32 x 3/4" f x 32 mm	5		32	27,5	9,5	43	51	38	44	3/4"	-	0,118
4125016	32 x 1" f x 32 mm	5		32	31,5	13,5	43	67	45	60	1"	39	0,274
4125018	40 x 1/2" f x 40 mm	5		40	41,5	21	52	40	27	37	1/2"	-	0,113
4125019	40 x 3/4" f x 40 mm	5		40	40,5	20	52	40,5	27,5	52	3/4"	-	0,157
4125020	40 x 1" f x 40 mm	5		40	41,5	21	52	56	34	60	1"	39	0,279
4125022	50 x 1" f x 50 mm	5		50	49,5	26	68	63,5	41,5	68,3	1"	39	0,387
4125024	50 x 1 1/4" f x 50 mm	5		50	49,5	26	68	66,5	47,5	68	1 1/4"	50	0,478
<b>NEW</b>	4125030	50 x 1/2" f x 50 mm	5	50	49,5	26	68	44,5	31,5	43	1/2"	-	0,237
<b>NEW</b>	4125031	50 x 3/4" f x 50 mm	5	50	49,5	26	68	44,5	31,5	43	3/4"	-	0,243

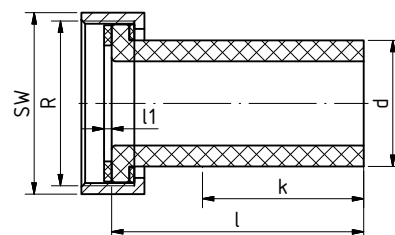
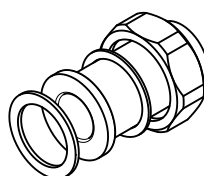

**aquatherm red pipe LOOSE NUT ADAPTER / B1**

Length: 100 mm threaded, with gasket

Art. no.	Dimension	PU m/pc	Price € m/pc	d	l	l1	k	R	SW	Weight
4126708	20 mm x nut thread 1"	1		20	100	3	65	1"	36	0,079
4126710	25 mm x nut thread 1 1/4"	1		25	100	3	62	1 1/4"	46	0,104
4126712	32 mm x nut thread 1 1/2"	1		32	100	3	58	1 1/2"	52	0,175
4126714	40 mm x nut thread 2"	1		40	100	3	53	2"	64	0,258
4126716	50 mm x nut thread 2 1/4"	1		50	100	3	49	2 1/4"	72	0,344
4126717	50 mm x nut thread 2 1/2"	1		50	100	3	44	2 1/2"	80	0,344
4126718	63 mm x nut thread 2 3/4"	1		63	100	3	43	2 3/4"	89	0,583
4126720	75 mm x nut thread 3 1/2"	1		75	100	3	34	3 1/2"	110	0,918
4126722	90 mm x nut thread 4"	1		90	100	3	26	4"	120	1,238

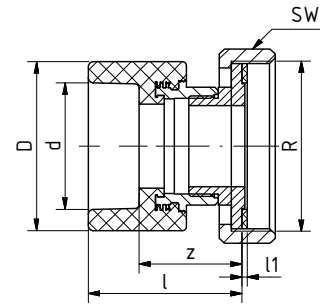
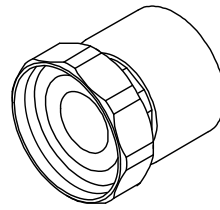

**aquatherm red pipe FEMALE PART UNION / B1**

ISO-Norm

Art. no.	Dimension	PU m/pc	Price € m/pc	d	l	z	D	R	SW	l1	Weight
4127010	nut thread 1" x 20 mm	10		20	58,5	34	38,5	1"	36	3	0,182
4127012	nut thread 1 1/4" x 25 mm	10		25	60	44	43,5	1 1/4"	46	3	0,274
4127014	nut thread 1 1/2" x 32 mm	5		32	69,5	51,5	60	1 1/2"	52	3	0,446
4127016	nut thread 2" x 40 mm	5		40	72	51,5	74	2"	64	3	0,719
4127018	nut thread 2 1/4" x 50 mm	5		50	77	53,5	84	2 1/4"	72	3	0,831
4127020	nut thread 2 3/4" x 63 mm	1		63	85	57	101	2 3/4"	89	3	1,306
4127022	nut thread 3 1/2" x 75 mm	1		75	91	61	100	3 1/2"	110	3	1,818

aquatherm red pipe metal composite fittings are manufactured from **Fusiolen®** PP-R FS and brass.

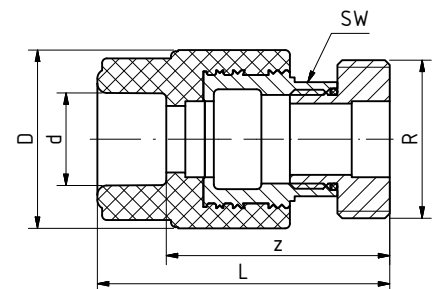
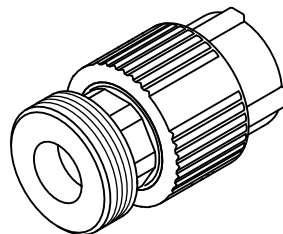

**aquatherm red pipe COUNTERPART / B1**

with welding socket and male thread for ISO-threaded joints

Art. no.	Dimension	PU m/pc	Price € m/pc	d	L	z	D	R	SW	Weight
4127310	20 mm x 1" m	10		20	61,5	47	37,5	1"	24	0,141
4127312	25 mm x 1 1/4" m	10		25	63	47	43,5	1 1/4"	31	0,221
4127314	32 mm x 1 1/2" m	5		32	76,5	58,5	60	1 1/2"	39	0,408
4127316	40 mm x thread 2" m	5		40	79	58,5	74	2"	50	0,635
4127318	50 mm x thread 2 1/4" m	5		50	83	59,5	84	2 1/4"	55	0,757
4127320	63 mm x thread 2 3/4" m	1		63	95	67,5	101	2 3/4"	67	1,214
4127322	75 mm x thread 3 1/2" m	1		75	100	70	100	3 1/2"	67	1,574

**TRANSITION PIECE**

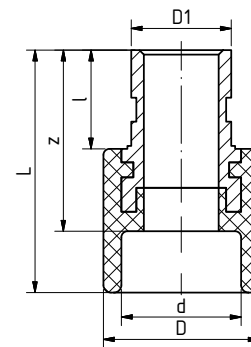
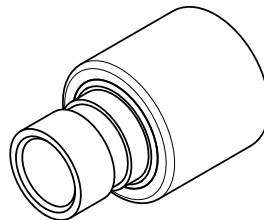

**aquatherm red pipe TRANSITION PIECE FOR GROOVE CONNECTION / B1**

Art. no.	Dimension	PU m/pc	Price € m/pc	d	L	z	D	D1	Weight
4127054	40 mm x 1" groove connection	1		40	81	60,5	52	33,5	0,239
4127056	50 mm x 1 1/4" groove connection	1		50	85,5	62	68	42,20	0,397
4127058	63 mm x 1 1/2" groove connection	1		63	97,5	70	84	48,25	0,568
4127060	75 mm x 2" groove connection	1		75	97	67	100	60,3	0,853
4127062	90 mm x 3" groove connection	1		90	110	77	120	88,9	1,285
4127064	110 mm x 4" groove connection	1		110	119,5	82,5	147	114,3	2,137
4127066	125 mm x 5" groove connection	1		125	170	130	167	140	5,046

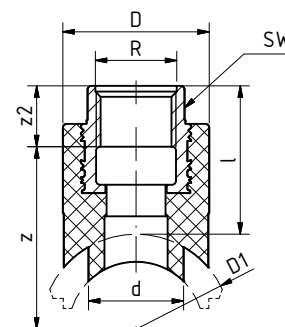
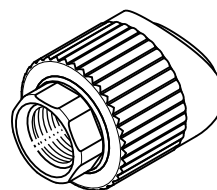

**aquatherm red pipe WELD-IN SADDLE WITH FEMALE THREAD / B1**

Art. no.	Dimension	PU m/pc	Price € m/pc	D1	d	l	z	z2	D	R	SW	Weight
4128214	40/25 mm x 1/2" f	5		40	25	39	43	16	38,5	1/2"	24	0,088
4128216	50/25 mm x 1/2" f	5		50	25	39	48	16	38,5	1/2"	24	0,090
4128218	63/25 mm x 1/2" f	5		63	25	39	54,5	16	38,5	1/2"	24	0,089
4128220	75/25 mm x 1/2" f	5		75	25	39	60,5	16	38,5	1/2"	24	0,097
4128222	90/25 mm x 1/2" f	5		90	25	39	68	16	38,5	1/2"	24	0,090
4128224	110/25 mm x 1/2" f	5		110	25	39	78	16	38,5	1/2"	24	0,089
4128226	125/25 mm x 1/2" f	5		125	25	39	85,5	16	38,5	1/2"	24	0,092
4128230	160/25 mm x 1/2" f	5		160	25	39	103	16	38,5	1/2"	24	0,092
4128234	40/25 mm x 3/4" f	5		40	25	39	38	21	43,5	3/4"	31	0,107
4128236	50/25 mm x 3/4" f	5		50	25	39	43	21	43,5	3/4"	31	0,110
4128238	63/25 mm x 3/4" f	5		63	25	39	49,5	21	43,5	3/4"	31	0,109
4128240	75/25 mm x 3/4" f	5		75	25	39	55,5	21	43,5	3/4"	31	0,109
4128242	90/25 mm x 3/4" f	5		90	25	39	63	21	43,5	3/4"	31	0,110
4128244	110/25 mm x 3/4" f	5		110	25	39	73	21	43,5	3/4"	31	0,110
4128260*	75/32 mm x 1" f	5		75	32	43	58,5	22	60	1"	39	0,088
4128262*	90/32 mm x 1" f	5		90	32	43	66	22	60	1"	39	0,222
4128264*	110/32 mm x 1" f	5		110	32	43	76	22	60	1"	39	0,088
4128266*	125/32 mm x 1" f	5		125	32	43	93,5	22	60	1"	39	0,091

with female thread and hexagon socket, with weld-in weld-on surface and weld-in socket to be fused with the inner wall of the pipe

The required tools for the fusion of **aquatherm red pipe** weld-in saddles are listed on page 34:

- Weld-in saddle tools, Art. no. 50614–50644

- **aquatherm** drill, Art. no. 50940–50948

\*suitable for the connection to sprinkler outlets

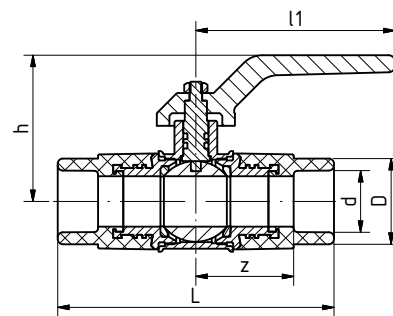
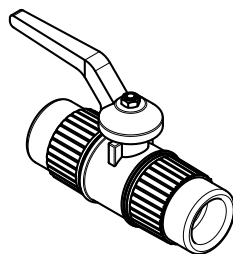

**aquatherm red pipe BALL VALVE PP/MS / B1**

Art. no.	Dimension mm	PU m/pc	Price € m/pc	d	L	z	D	h	l1	Weight
4141308	20	1		20	110	40,50	29,5	56	79	0,280
4141310	25	1		25	110	39	34	58	79	0,375
4141312	32	1		32	127	45,5	43	66	103	0,592
4141314	40	1		40	145	52	52	71	104	1,034
4141316	50	1		50	167	60	68	79	140	1,339
4141318	63	1		63	205	75	84	88	140	2,552

aquatherm red pipe metal composite fittings are manufactured from **Fusiofen®** PP-R FS and brass.

**CUTTER & WELDING DEVICES**

**aquatherm PIPE CUTTER**

Art. no.	for pipe dimensions	PU m/pc	Price € m/pc
50102	ø 16–40 mm	1	
50105	ø 50–125 mm	1	
50106	ø 110–160 mm	1	

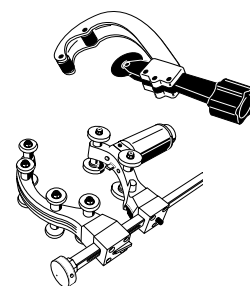

**aquatherm PIPE CUTTER**

Art. no.	for pipe dimensions	PU m/pc	Price € m/pc
50104	ø 16–40 mm	1	

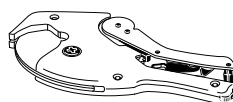

**Important:** Do not cut the aquatherm red pipe pipes with customary hack saws.  
aquatherm red pipe pipes can be cut with customary saws equipped with saw blades suitable for plastic.

**ORBITAL CIRCULAR SAW**

Art. no.	for pipe dimensions	PU m/pc	Price € m/pc
50108	ø 160–355 mm	1	

This orbital circular saw can be ordered directly from Rothenberger with Art. no. 5.5620 ([www.rothenberger.com](http://www.rothenberger.com)). High-performance orbital circular saw for fast, precise, perfectly aligned and right-angled cutting of plastic pipes 160–355 mm at the building site or in the workshop.

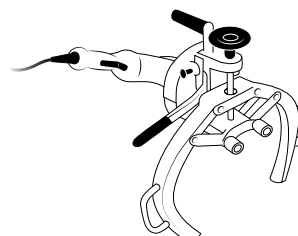

**CUTTING DISC FOR PLASTIC**

Art. no.	Dimension	Borehole	PU m/pc	Price € m/pc
50107	ø 125 mm	22,2 mm	1	
50109	ø 230 mm	22,2 mm	1	

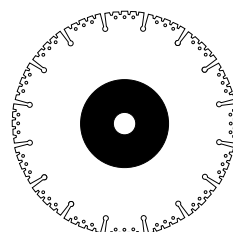

Application: for each angle grinder  
Design: diamond galvanized cutting disc

**aquatherm MANUAL WELDING DEVICE (500 W)**

Art. no.	for pipe dimensions	PU m/pc	Price € m/pc
50336	ø 16–32 mm	1	

With base and case for tools

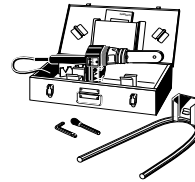

**aquatherm MANUAL WELDING DEVICE (800 W)**

Art. no.	for pipe dimensions	PU m/pc	Price € m/pc
50337	ø 16–63 mm	1	

With base and case for tools

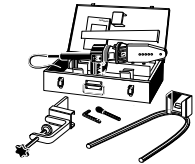

**aquatherm MANUAL WELDING DEVICE (1400 W)**

Art. no.	for pipe dimensions	PU m/pc	Price € m/pc
50341	ø 50–125 mm	1	

With base and case for tools

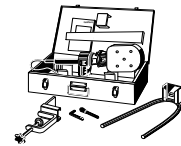

**aquatherm WELDING MACHINE (1400 W)**

Art. no.	for pipe dimensions	PU m/pc	Price € m/pc
50148	ø 50–125 mm	1	

incl. welding tools 50–125 mm, roll stand and wooden transport case

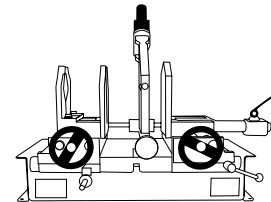

**aquatherm ELECTRIC WELDING JIG**

Art. no.	for pipe dimensions	PU m/pc	Price € m/pc
50159	ø 63–125 mm	1	

incl. spare battery, charging station and metal case Support: Art. no. 50151 on request

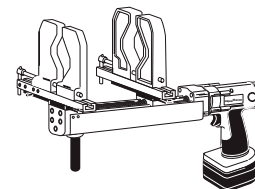

**aquatherm BASE FOR ART. NO. 50159**

Art. no.	Dimension	PU m/pc	Price € m/pc
50151		1	

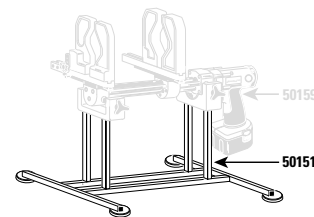

**aquatherm WELDING MACHINE (1400 W) LIGHT**

Art. no.	for pipe dimensions	PU m/pc	Price € m/pc
50145	ø 63–125 mm	1	

aquatherm manual welding device (1400 W) and wooden transport case

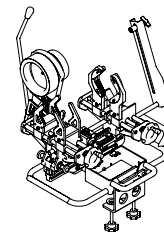

**BUTT WELDING MACHINE WIDOS**

Art. no.	Dimension	PU m/pc	Price € m/pc
50352*	ø 160–250 mm	1	

The butt-welding-machine can be purchased directly from Widos ([www.widos.de](http://www.widos.de))

\* Also available in design with 110 volt (Art. no. 450352 = ø 160–250 mm / 450353 = ø 160–315 mm / 450353 = ø 160–315 mm / 450354 = ø 160–355 mm / 450355 = ø 200–450 mm)

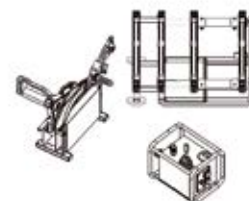



### BUTT WELDING MACHINE RITMO

Art. no.	for pipe dimensions	PU m/pc	Price € m/pc
50165	ø 160–250 mm	1	

incl. wooden transport box.

The butt welding machine can be obtained directly from Ritmo ([www.ritmo.it](http://www.ritmo.it)).

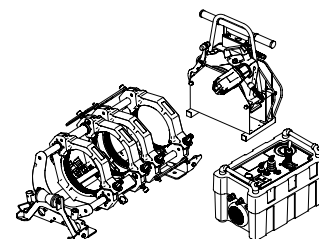

### aquatherm TEMPERATURE MEASURING DEVICE

Art. no.	Dimension	PU m/pc	Price € m/pc
50188		1	

to check the correct welding temperature



### aquatherm THERMOCOLOUR PENCIL

Art. no.	Dimension	PU m/pc	Price € m/pc
50190		1	

to check the correct welding temperature

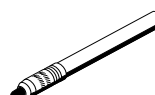

### aquatherm CLEANING WIPES

Art. no.	Dimension	PU m/pc	Price € m/pc
50193	Box with 100 towels	1	

for electrofusion sockets



### aquatherm WELDING TOOL

Art. no.	Dimension mm	PU m/pc	Price € m/pc
50206	50	1	
50208	16	1	
50210	20	1	
50212	25	1	
50214	32	1	
50216	40	1	
50218	50	1	
50220	63	1	
50222	75	1	
50224	90	1	
50226	110	1	

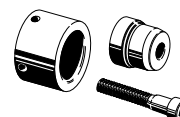

### aquatherm REPAIR KIT

Art. no.	Dimension	PU m/pc	Price € m/pc
50307	7 mm	1	
50311	11 mm	1	

to close pipe holes up to 10 mm (pipe repair stick Art. no. 60600)



### aquatherm red pipe REPAIR STICK

Art. no.	Dimension	PU m/pc	Price € m/pc
4160600	7/11 mm	1	

Material: **Fusiolen** PP-R FS to close pipe holes up to 10 mm.

Tool: **aquatherm green pipe** repair kit (Art. no. 50307 + 50311).

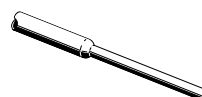

**WELDING TOOLS & DRILLS**

**aquatherm WELDING TOOL**

for welding saddles of Art. no. 4115156–4115198 and 4128214–4128266

Art. no.	Dimension	PU m/pc	Price € m/pc
50614	40 x 20/25 mm	1	
50616	50 x 20/25 mm	1	
50619	63 x 20/25 mm	1	
50620	63 x 32 mm	1	
50623	75 x 20/25 mm	1	
50624	75 x 32 mm	1	
50625	75 x 40 mm	1	
50627	90 x 20/25 mm	1	
50628	90 x 32 mm	1	
50629	90 x 40 mm	1	
50631	110 x 20/25 mm	1	
50632	110 x 32 mm	1	
50634	110 x 40 mm	1	
50635	110 x 50 mm	1	
50636	125 x 20/25 mm	1	
50638	125 x 32 mm	1	
50640	125 x 40 mm	1	
50642	125 x 50 mm	1	
50644	125 x 63 mm	1	
50648	160 x 20/25 mm	1	
50650	160 x 32 mm	1	
50652	160 x 40 mm	1	
50654	160 x 50 mm	1	
50656	160 x 63 mm	1	
50657	160 x 75 mm	1	
50658	160 x 90 mm	1	

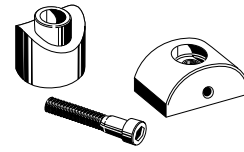

**aquatherm DRILL**

for installation of weld-in saddles

Art. no.	Dimension	PU m/pc	Price € m/pc
50940	20 & 25 mm (for pipes 40–160 mm)	1	
50941	32 mm	1	
50942	40 mm	1	
50944*	50 mm	1	
50946*	63 mm	1	
50950**/**	75 mm	1	
50952**/**	90 mm	1	

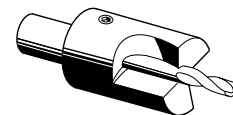

\* may only be used in fixed drilling machines!



\*\* tool holder MK4

**aquatherm red pipe EXTRACTION TOOL**

for sprinkler outlet Art. no. 4114181–93

Art. no.	Dimension	PU m/pc	Price € m/pc
50290		1	

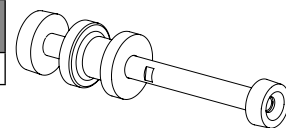

**NEW aquatherm red pipe ADJUSTING TOOL**

for compensating joint with adapter 3/8" male, 1/2" male, 1" male

Art. no.	Dimension	PU m/pc	Price € m/pc
50291		1	

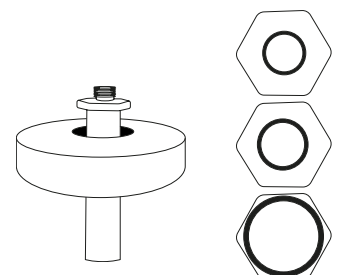

**PART A:****Mounting of the welding tools****1. Important!**

- Only use original aquatherm welding devices and aquatherm welding tools.
- 2. Assemble and tighten the cold welding tools manually.
- 3. All welding tools must be free from impurities. Check, if they are clean before assembling. If necessary, clean the welding tools with a non-fibrous, coarse tissue and with spirit.
- 4. Place the welding tools, so that there is full surface contact between the welding tool and the welding plate. Welding tools over  $\varnothing$  40 mm must always be fitted to the rear position of the welding plate.
- 5. Plug in the welding device and check, if operating lamp is on. Depending on the ambient temperature it takes 10–30 minutes to heat-up the welding plate.

**The heat-up phase ends, when the temperature pilot lamp blinks and a signal is audible.**

**Electric power supply:**

The power supply must coincide with the data on the type plate of the welding device and must be protected according to the local regulations. To avoid high power loss, the conductor cross-section of the used extension cables must be selected according to the power input of the welding devices.



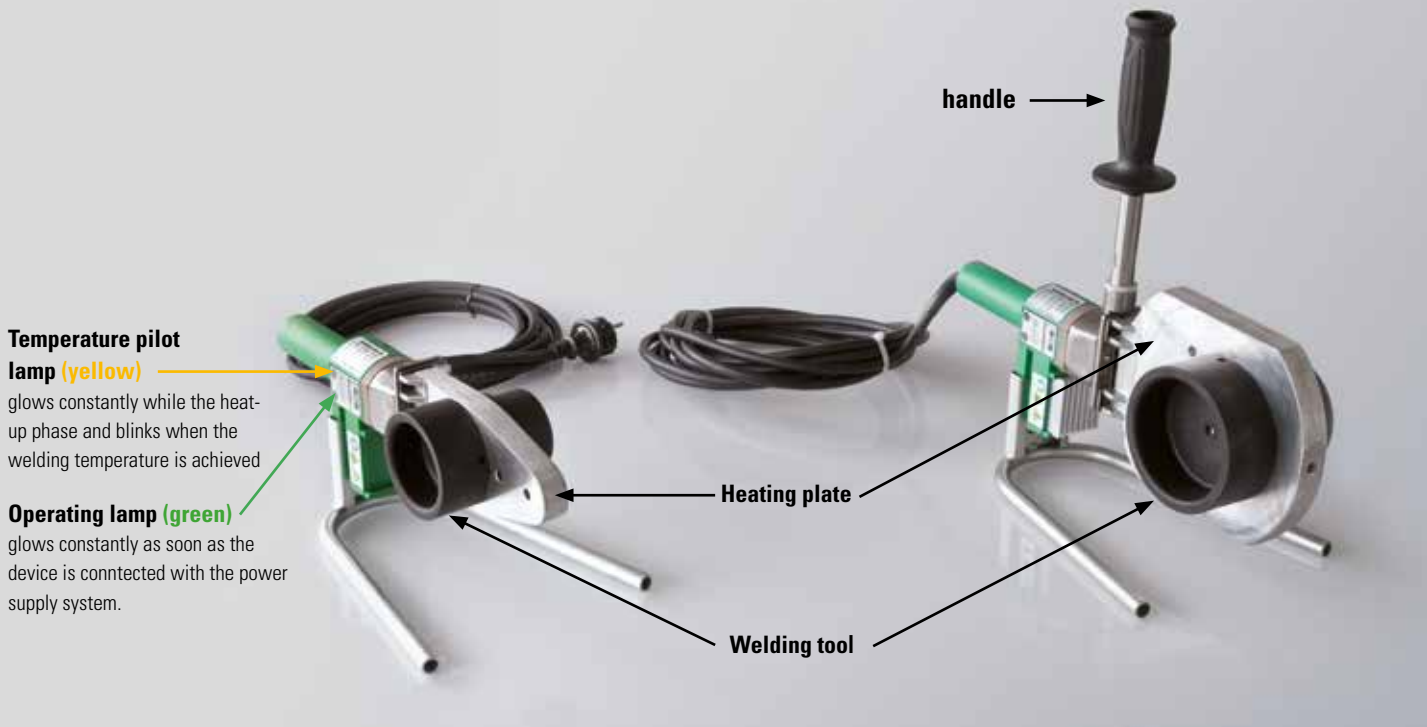

**Temperature pilot lamp (yellow)**

glows constantly while the heat-up phase and blinks when the welding temperature is achieved

**Operating lamp (green)**

glows constantly as soon as the device is connected with the power supply system.

handle →

Heating plate

Welding tool

**PART A:**

**Heat-up phase**

6. During the heat-up phase tighten the welding tools carefully with the Allen Key. Take care that the tools fully contact the welding plate. Never use pliers or any other unsuitable tools, as this will damage the coating of the welding tools.
7. The required temperature to weld the aquatherm red pipe system is 260 °C. Acc. to DVS-Welding Guidelines, the temperature of the welding device has to be checked at its tool before starting the welding process. This has to be done with a fast indicating thermometer or alternatively with an aquatherm green pipe thermocolour crayon. (see "Fusion part B, item 2")
8. A tool change on a heated device requires another check of the welding temperature at the new tool (after heat-up phase).
9. If the device has been unplugged, i. e. during longer breaks, the heat-up process has to be restarted (from item 5).
10. After use unplug the welding device and cool down. Water must never be used to cool the welding device, as this would destroy the heating resistances.

**ATTENTION:**

First welding at the earliest 10 minutes after reaching the welding temperature DVS 2207, Part 11.

**PART A:**

**Handling**

11. Protect aquatherm welding devices and tools against impurities. Burnt-in particles may result in an incorrect fusion. The tools may be cleaned with aquatherm cleaning wipes, Art. no. 50193. Always keep the burnt-in welding tools dry. If necessary, dry them with a clean, non-fibrous tissue.
12. For perfect fusion, damaged or dirty welding tools must be replaced, as only undamaged tools ensure a perfect fusion welding.
13. Never attempt to open or repair a defective device. Return the defective device for repair.
14. Check the operating temperature of the aquatherm green pipe welding devices regularly by means of suitable measuring instruments.

**PART A:**

**Guidelines**

15. For the correct handling of welding machines the following must be observed:  
  
General Regulations for Protection of Labour and Prevention of Accidents  
  
and particularly  
  
the Regulations of the Employers' Liability Insurance Association of the Chemical Industry regarding Machines for the Processing of Plastics, chapter: „Welding Machines and Welding Equipment“.
16. For the handling of the aquatherm welding machines, devices and tools please observe  
  
General Regulations DVS 2208 Part 1 of the German Association for Welding Engineering, Registered Society (Deutscher Verband für Schweißtechnik e. V.).

**PART B:****Checking of devices and tools**

1. Check, if the aquatherm welding device and tool correspond to the guidelines "Fusion Part A".
2. All devices and tools in use must have reached the required operating temperature of 260 °C in use. This needs a separate, compulsory test, acc. to DVS-Welding Guideline. The control of the operating temperature can be made with fast indicating thermometers.

Suitable measuring instruments must offer a temperature measurement of up to 350 °C with a high accuracy.

Alternatively it is also possible to check the welding temperature with the aquatherm thermocolour crayon. The application of the special thermo-colour chalk in the aluminium crayon enables an exact reading with a tolerance of +/- 5 K to heated surfaces.

**Application:**

After the temperature pilot lamp of the welding device has indicated the end of the heat-up period, put a firm chalk line on the heated external surface of the welding tool. The colour must change within 1–2 seconds.

If the temperature is too high, the colour will change immediately and if it is too low (below 260 °C) it will change after 3 or more seconds.

**If the colour does not change within 1–2 seconds, another temperature test has to be carried out, respectively the control of the welding device is required.**



Measurement of temperature at the aquatherm manual welding device (800 W)



Temperature control aquatherm welding device (1400 W)



Temperature control aquatherm welding machine



Temperature control with the aquatherm thermocolour crayon



Measurement of temperature at the aquatherm butt-welding machine

**PART B:**

**Preparation for the fusion**

3. Cut the pipe right-angled to the pipe axis.  
  
Only use aquatherm green pipe pipe cutters or other suitable cutting tools. Take care that the pipe is free from burrs or cutting chips and remove if necessary.
4. Mark the welding depth at the end of the pipe with the enclosed pencil and template.
5. Mark the desired position of the fitting on the pipe and/or fitting.  
  
The auxiliary markings on the fitting and the continued line on the pipe may be used as a help.

**The fusion is subject to the following data**

Pipe external-Ø	Welding depth	Heat-up time	Welding time	Cooling time
mm	mm	sec. DVS	sec	min.
20	14,5	5	4	2
25	16,0	7	4	2
32	18,0	8	6	4
40	20,5	12	6	4
50	23,5	18	6	4
63	27,5	24	8	6
75	30,0	30	8	8
90	33,0	40	8	8
110	37,0	50	10	8
125	40,0	60	10	8

**The General Guidelines for Heated Socket Welding acc. to DVS 2207 Part 11 apply.**



Cutting of the pipe



Marking of the welding depth





**PART B:**  
Heat-up of pipe and fittings

6. Push the end of the pipe, without turning, up to the marked welding depth into the welding tool and at the same time the fitting, without turning, as far as it will go on the tool. It is essential to observe the above mentioned heating times.

Pipes and fittings of the dimensions  $\varnothing$  75 to 125 mm may only be welded with welding device Art. no. 50341 (or with machine Art. no. 50148). On using the aquatherm green pipe welding machine Art. no. 50148, a separate operating instruction has to be observed.

**ATTENTION:**

The heating time starts, when pipe and fitting have been pushed with the correct welding depth on and in the welding tool. Not before!

**PART B:**  
Setting and alignment

7. After the stipulated heat-up time quickly remove pipe and fitting from the welding tools. Join them immediately, without turning, until the mark welding depth is covered by PP-bead of the fitting.

**ATTENTION:**

**Do not push the pipe too far into the fitting, as this would reduce the bore and in an extreme case may close the pipe.**

8. The joint elements have to be fixed during the specified processing time. Use this time to correct the connection. Correction is restricted to the alignment of pipe and fitting. Never turn the elements or align the connection after the processing time.
9. After the cooling period the fused joint is ready for use.

**The result of the fusion of pipe and fitting is a permanent material joining of the system elements.**

**Unrivalled connection technique with security for a life-time!**

## VISUAL INSPECTION OF FUSION SEAM

Normally on fusioning a bead is formed around the entire circumference at the edge of the socket. This bead is an indication of proper welding.

Incorrect shape of bead

**1**

Different shape of bead (b) or non-existent bead at one or at both ends (a) (partial or total extent), resulting from:

- Temperature of heating tool is too low (a)
- Heat-up time too short (a)
- Unacceptable tolerances (a and b)
- Excessive temperature of heating tool (b)
- Heat-up time too long (b)

**2**

Single shape of bead, resulting from:

- Heat-up time too short
- Temperature of heating tool is too low
- Unacceptable tolerances
- Heat-up of only one welding part

**3**

Excessive melting, resulting from:

- Temperature of heating tool is too high
- Misaligned movement of welding-part, e.g. by inadequate fixing
- Unacceptable tolerances

**4**

Elbow variance

Partially or double-sided inclined welded pipe into the socket without or with slight bracing, resulting from:

- Machinery defect
- False installation

Acceptable, if  $e \leq 2 \text{ mm}$

**5**

Mistake of bonding by improper pipe insertion, resulting from:

- Heat-up time too short
- Pipe ends not at  $90^\circ$  (right-angled)
- Heating temperature too low
- Axial movement during cooling time
- Change-over time too long

Acceptable up to  $0.1 \times d$  and  $0.15 \times$  socket depth



**VISUAL INSPECTION OF FUSION SEAM**

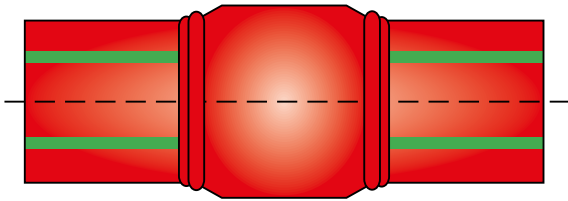

correct fusion welding

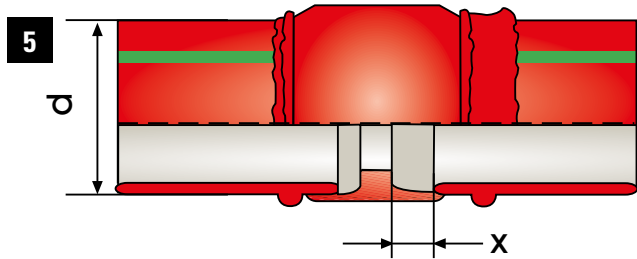
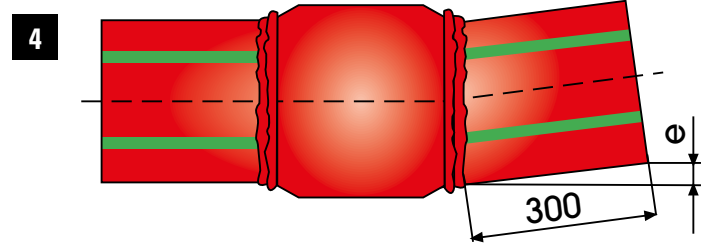
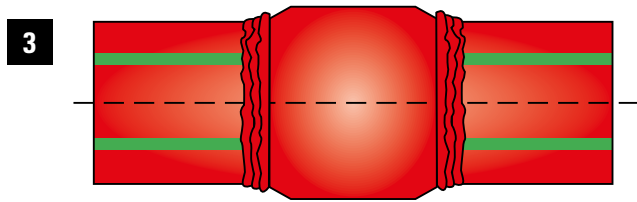
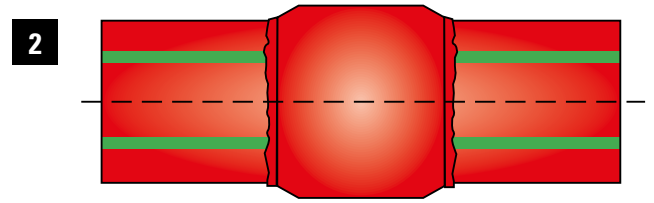
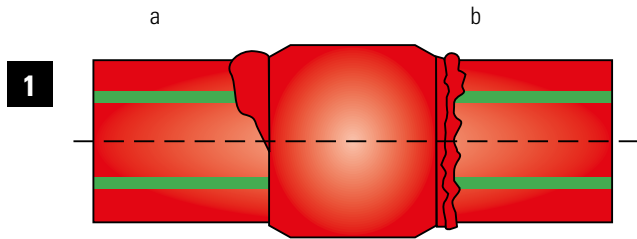

**The visual inspection may be only a first indication of the welding seam quality.**

**But it is not a replacement for the leak test, which has to be carried out after the completion of the installation.**

Source:  
DVS 2202-1, to purchase at DVS-publisher, Düsseldorf Copyright Publisher for fusion and related procedures DVS-Verlag GmbH

**PART C:**  
**Weld-in saddles**

For pipe external diameters of 40, 50, 63, 75, 90, 110, 125, 160 mm

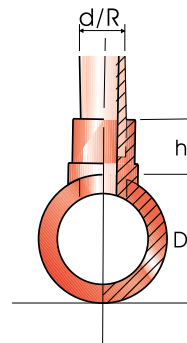

Art. no.	Dimension	D	d	R	h	Sensorwells	Drill	Welding Tool
		mm	mm	f	mm	ø mm	Art. no.	Art. no.
4115156	40/20 mm	40	20	-	27,0	-	50940	50614
4115158	40/25 mm	40	25	-	28,0	-	50940	50614
4115160	50/20 mm	50	20	-	27,0	-	50940	50616
4115162	50/25 mm	50	25	-	28,0	-	50940	50616
4115164	63/20 mm	63	20	-	27,0	-	50940	50619
4115166	63/25 mm	63	25	-	28,0	-	50940	50619
4115168	63/32 mm	63	32	-	30,0	-	50942	50620
4115170	75/20 mm	75	20	-	27,0	-	50940	50623
4115172	75/25 mm	75	25	-	28,0	-	50940	50623
4115174	75/32 mm	75	32	-	30,0	-	50942	50624
4115175	75/40 mm	75	40	-	34,0	-	50944	50625
4115176	90/20 mm	90	20	-	27,0	-	50940	50627
4115178	90/25 mm	90	25	-	28,0	-	50940	50627
4115180	90/32 mm	90	32	-	30,0	-	50942	50628
4115181	90/40 mm	90	40	-	34,0	-	50944	50629
4115182	110/20 mm	110	20	-	27,0	-	50940	50631
4115184	110/25 mm	110	25	-	28,0	-	50940	50631
4115186	110/32 mm	110	32	-	30,0	-	50942	50632
4115188	110/40 mm	110	40	-	34,0	-	50944	50634
4115189	110/50 mm	110	50	-	34,0	-	50946	50635
4115190	125/20 mm	125	20	-	27,0	-	50940	50636
4115192	125/25 mm	125	25	-	28,0	-	50940	50636
4115194	125/32 mm	125	32	-	30,0	-	50942	50638
4115196	125/40 mm	125	40	-	34,0	-	50944	50640
4115197	125/50 mm	125	50	-	34,0	-	50946	50642
4115198	125/63 mm	125	63	-	38,0	-	50948	50644
4115218	160/75 mm	160	75	-	42,0	-	50950	50657
4115220	160/90 mm	160	90	-	45,0	-	50952	50658
4128214	40/25x1/2" f.	40		1/2"	39,0	14	50940	50614
4128216	50/25x1/2" f.	50		1/2"	39,0	14	50940	50616
4128218	63/25x1/2" f.	63		1/2"	39,0	14	50940	50619
4128220	75/25x1/2" f.	75		1/2"	39,0	14	50940	50623
4128222	90/25x1/2" f.	90		1/2"	39,0	14	50940	50627
4128224	110/25x1/2" f.	110		1/2"	39,0	14	50940	50631
4128226	125/25x1/2" f.	125		1/2"	39,0	14	50940	50636
4128234	40/25x3/4" f.	40		3/4"	39,0	16	50940	50614
4128236	50/25x3/4" f.	50		3/4"	39,0	16	50940	50616
4128238	63/25x3/4" f.	63		3/4"	39,0	16	50940	50619
4128240	75/25x3/4" f.	75		3/4"	39,0	16	50940	50623
4128242	90/25x3/4" f.	90		3/4"	39,0	16	50940	50627
4128244	110/25x3/4" f.	110		3/4"	39,0	16	50940	50631
4128246	125/25x3/4" f.	125		3/4"	39,0	16	50940	50636
4128260	75/32x1" f.	75		1"	43,0	20	50942	50624
4128262	90/32x1" f.	90		1"	43,0	20	50942	50628
4128264	110/32x1" f.	110		1"	43,0	20	50942	50632
4128266	125/32x1" f.	125		1"	43,0	20	50942	50638

**PART C:****Weld-in saddles**

1. Before starting the welding process, check if the aquatherm welding devices and tools meet the requirements of "Fusion Part A".
2. The first step is to drill through the wall of the pipe at the point intended for the outlet by using the aquatherm drill.

branch 20/25 mm:	Art. no. 50940/41
branch 32 mm:	Art. no. 50942
branch 40 mm:	Art. no. 50944
branch 50 mm:	Art. no. 50946
branch 63 mm:	Art. no. 50948
branch 75 mm:	Art. no. 50950
branch 90 mm:	Art. no. 50952

3. The welding device/saddle welding tool must have reached the required operating temperature of 260 °C (check with reference to "Fusion Part B, item 2").
4. The welding surfaces have to be clean and dry.
5. Insert the heating tool on the concave side of the weld-in saddle tool into the hole drilled in the side wall of the pipe until the tool is completely in contact with the outer wall of the pipe. Next the weld-in saddle spigot is inserted into the heating sleeve until the saddle surface is up against the convex side of the welding tool. The heating time of the elements is generally 30 seconds.
6. After the welding tool has been removed, the weld-in saddle spigot is immediately inserted into the heated, drilled hole. The weld-in saddle should then be pressed on the pipe for about 15 seconds. After being allowed to cool for 10 minutes, the connection can be exposed to its full loading. The appropriate branch pipe is fitted into the sleeve on the aquatherm weld-in saddle using conventional fusion technology.

By fusing the weld-in saddle with the pipe outer surface and the pipe inner wall, the connection reaches highest stability.



Drilling through the pipe wall



Heat-up of pipe...



...and fitting



Joining

**PART D:**  
**aquatherm welding machine**

- One wooden transport box for the welding machine
- aquatherm welding tools diameter 50, 63, 75, 90, 110, 125 mm
- One Allan key and tool change clamp
- One aquatherm thermocolour crayon
- One Installation manual
- One roll stand

The aquatherm welding machine was especially developed for stationary welding of pipe and fittings with an external diameter of 50 to 125 mm. This machine is equipped with a hand crank to facilitate a precise pre-assembly of complicated installation parts.



**The fusion is subject to the following data**

Pipe-external-Ø	Welding depth	Heating time	Welding time	Cooling time
mm	mm	sec. DVS	sec	min.
50	23,5	18	6	4
63	27,5	24	8	6
75	30,0	30	8	8
90	33,0	40	8	8
110	37,0	50	10	8
125	40,0	60	10	8

The General Guidelines for Heated Tool Socket Welding acc. to DVS 2207 Part 11 apply.

**Dimension 160 mm:**

The dimension 160 mm is joined by butt-welding. Detailed information on pages 46 + 47.

**PART D:**  
**Support intervals**

aquatherm red pipe SDR 7.4											SDR 11
Pipe diameter d [mm]											
20	25	32	40	50	63	75	90	110	125	160	
Support intervals in cm											
120	140	160	180	205	230	245	260	290	320	285	

Table to determine support intervals in conjunction with outside diameter.

## PART E: welding machine prisma-light

- with heating plate without tools
  - clamping fixture for fixing the prisma-light, e. g. at the work bench
1. Check machine: temperature lamp blinks after reaching the welding temperature (260 °C), adjust clamping jaws 63–125 mm coarsely. Mark welding depth with the template at the pipe.
  2. Fix the fitting against the clamping jaws.
  3. Place the pipe loose in the opposite clamping jaws.
  4. Position the welding device centrally to the pipe-fitting axis and remove it.
  5. Lock the front calibration knob and drive up the slide as far as it will go.
  6. In this position, push the pipe against the fitting and fix it with the clamping jaws.
  7. Regulate the welding time according to the table on page 38 place the welding device and push the fitting and pipe slowly as far as it will go up to the marking.
  8. The heating time starts when pipe and fitting are completely pushed on the tool. When heating time is complete, return the slide, remove the heating device quickly and join the pipe and fitting.
  9. Consider cooling times from the table on page 38.

More detailed information can be taken from the enclosed operating manuals.

## PART F: Repair

Damaged pipes may be repaired – as already mentioned – by fusion welding (see part B). In addition, the aquatherm red pipe system offers the possibility of repair by repair stick.

The suitable welding tool (Art. no. 50307/11) and the repair stick (Art. no. 4160600) are described on page 33.

The installation information is enclosed with the welding tool, but may also be ordered separately.

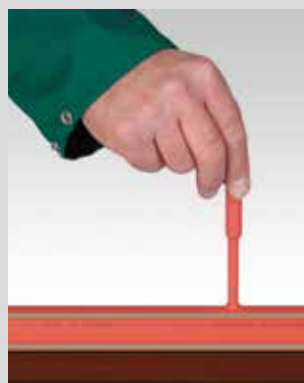
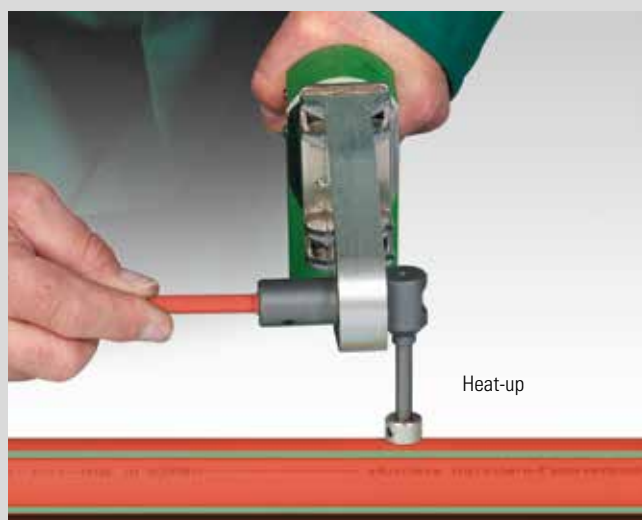

Pipe repair stick



Cutting

**PART G:  
BUTT-WELDING OF PIPE DIMENSION 160 mm**

The following aquatherm red pipe series are available:

aquatherm red pipe SDR 11 MF (faser composite pipe)

Pipes and fittings are fused, as explained below, by butt welding:

1. Protect your place of work from weather influences
2. Check, if welding machine works properly and heat it up
3. Cut pipes into required length
4. Plastic pipes are aligned and fixed by means of the clamping elements
5. Use the milling machine for planing the pipe end to be plane-parallel
6. Remove the debris and clean the pipe ends with methylated spirit
7. Check if pipes match (tolerance: max. 0.1 x wall thickness)
8. Check width of gap between the two pipes to be welded (tolerance: max. 0.5 mm)
9. Check the temperature of the heating element (210 °C +/- 10 °C)
10. Clean the heating element



Before welding, pipes are cut into the required lengths



Check performance of the welding machine and heat it up

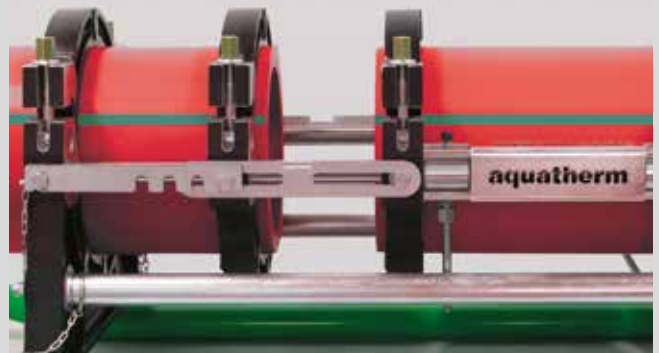

The parts to be welded are fixed and aligned respectively, the milling machine is used





**PART G:****BUTT-WELDING OF PIPE DIMENSION 160 mm**

11. After the heating element has been positioned, the pipes are pushed onto the heating plate with a defined adjusting pressure.
12. After reaching the specified bead height (see tablet), the pressure is reduced. This process marks the beginning of the heating time. This time is for heating up the pipe ends up to the right welding temperature.

Specified bead height: **SDR 11** 160 mm: 1,0 mm

13. When heating time has expired, divide the machine slide, remove heating element quickly and join the pipes (by putting both parts of the slide together).
14. The pipes are fused with the required welding pressure and cooled down under pressure.
15. The welded connection can be unclamped – the welding process is finished.

Additionally please follow the instructions given in the operating manual of the welding machine and observe guideline DVS 2207, part 11.

**Important Note**

1. The welding machines have to be suitable for the welding of pipes with a diameter/wall thickness ratio of up to SDR 11.

aquatherm recommends the following manufacturers of welding machines for butt welding:

Company Ritmo  
Company Widos

2. For hydraulically operated welding machines, the real manometer pressure has to be calculated in consideration of the hydraulic piston area.

This value can be taken from the respective operating manuals.



Positioning of heating element

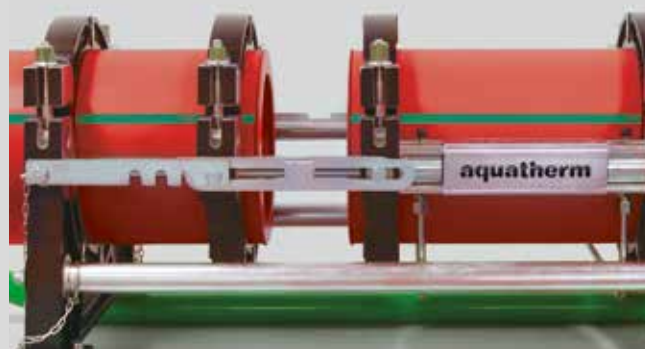

Divide the machine slide, remove heating element



Join the pipes, cool down under pressure



Unclamp and work on...

### Visual inspection of fusion seam – Misalignment and gap width for butt welding

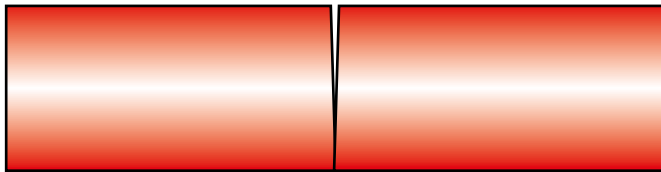

Gap width up to 355 mm outer diameter = 0.5 mm  
 Gap width from 400 mm to 630 mm outer diameter = 1 mm

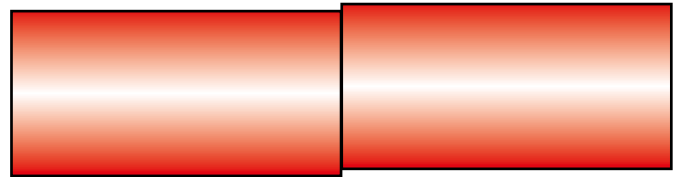

The misalignment cannot be more than 10 % of the wall thickness or max. 2 mm

### Welding defects during butt-welding

Normally, a bead around the entire circumference is formed at the edge of the socket during the welding process. This bead indicates the proper welding. It is important to assure that the following welding defects are avoided:

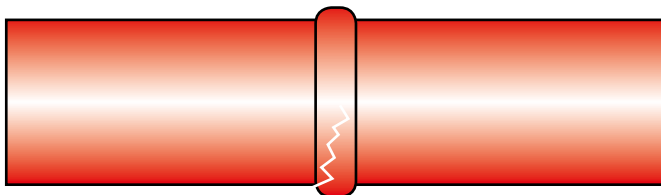

Cracks

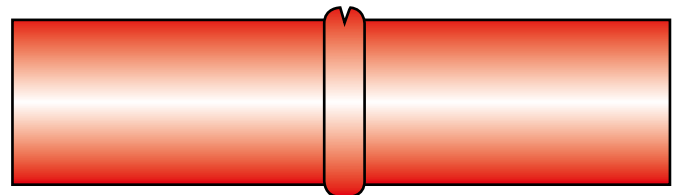

Grooves in the bead

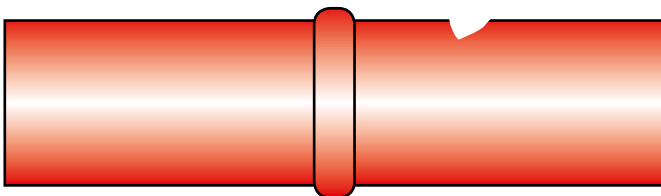

Grooves and scratches

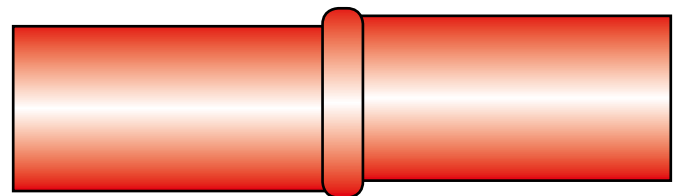

Misalignment of the joining area

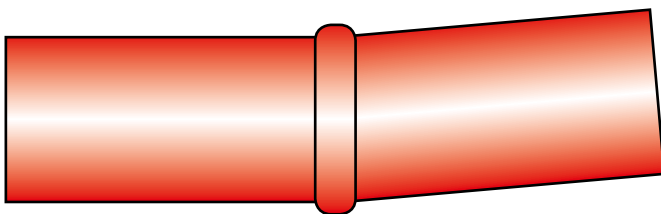

Tilting of the joining area

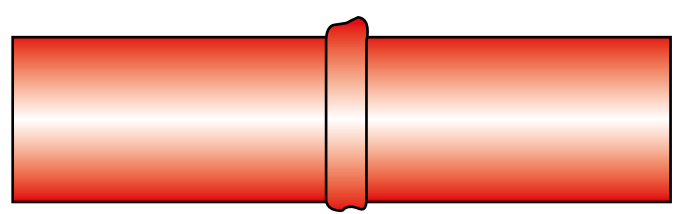

Uneven welding bead

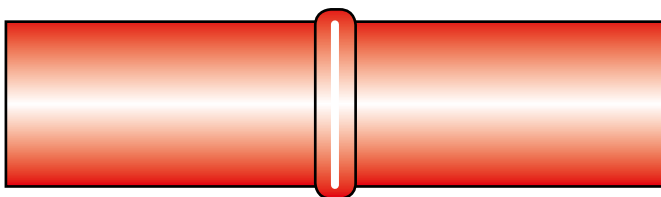

Lack of fusion at the joining area

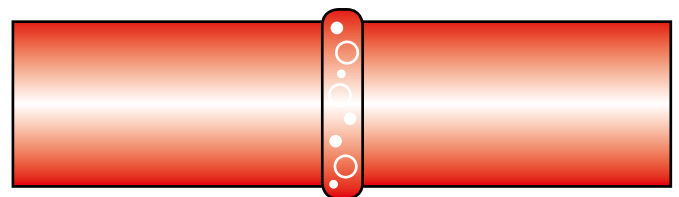

Pores, voids and inclusion of impurities



## Correct butt welded seam

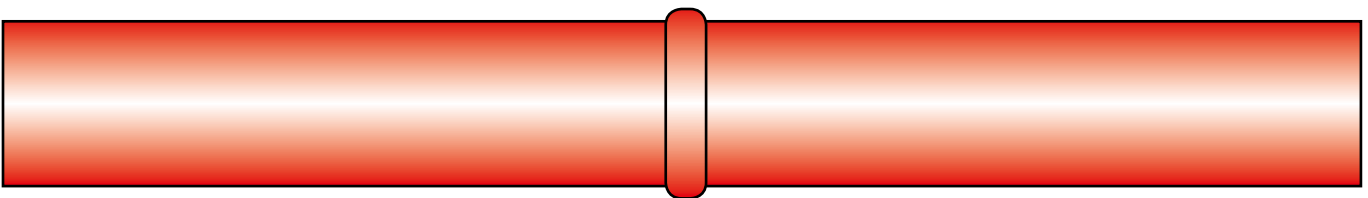

**The visual inspection may be only a first indication of the welding seam quality. But it is not a replacement for the leak test, which has to be carried out after the completion of the installation.**

## Requirements for welding



The immediate welding area is to be protected against bad climatic conditions (e.g. wind, moisture and low temperatures).



If the pipes are heated unevenly as a result of sun exposure, temperature compensation by timely covering of the welding area is to be created. Cooling down by draft during the welding process should be avoided.



For perfect welding joints, both the welding areas and tools must be clean and free of grease.

**AQUATHERM WELDING PARAMETERS**  
**WELDING TEMPERATURE: 210 °C +/- 10 °C**

The calculated drag pressure is added to the adjustment and welding pressure (see description).

**ATTENTION:** When using other welding machines, the pressures P1, P2 and P3 must be adjusted.

**Note:** A reduction of the cooling time up to 50 %, i.e. release of the jointing pressure and removal of the welded part from the welding machine is allowed under the following conditions:

- The joint connection is manufactured under factory conditions and
- The removal from the welding machine and the temporary storage cause only a slight load to the joint connection and
- The joining parts have a wall thickness  $\geq 15$  mm

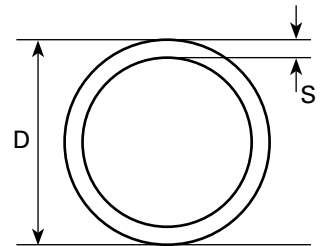

Further processing with full mechanical load on the joining connection may be effected only after complete cooling down according to the table.

**Excerpt from the DVS 2207 part 11**

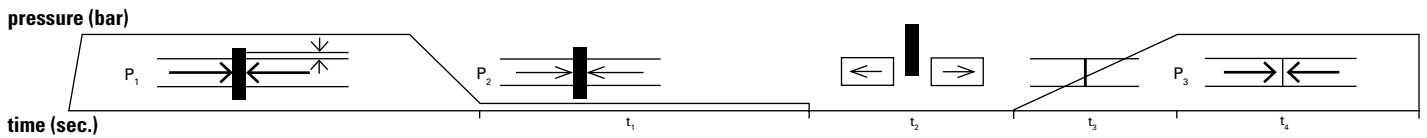

		P1 Adjustment pressure (bar)		Height of bead (mm)
Dimension (mm)	Pipe series SDR	Rothenberger Art. no. 50163	Ritmo Art. no. 50165	
160x14,6	11	11	11	H
				1

		P2 Heating pressure (bar)		Heating time DVS 2207 (sec.)	Max. changeover time (sec.)	Max. pressurization time (sec.)
Dimension (mm)	Pipe series SDR	Rothenberger Art. no. 50163	Ritmo Art. no. 50165			
160x14,6	11	1	1	t1	t2	t3
				277	8	13

		P3 Adjustment pressure (bar)		Cooling time (min.)
Dimension (mm)	Pipe series SDR	Rothenberger Art. no. 50163	Ritmo Art. no. 50165	
160x14,6	11	11	11	t4
				24



Picture 1

## LAYING OF **AQUATHERM RED PIPE** IN THE CONCRETE

### Part 1:

#### Connecting of pipe work to the aquatherm red pipe sprinkler outlet

The connection is described in picture 1 as follows:

The base part of the sprinkler outlet (1) is screwed with 4 screws on the shuttering.

Brass plug (2), upper part of the sprinkler outlet (3) and aquatherm red pipe connection piece (4) are connected to each other and plugged onto the base part of the sprinkler outlet (1), so that part 3 is flush with the shuttering.

Part 2, 3 and 4 are bolted together and plugged on part 1, so that part 3 is flush with the casing.

The O-ring on part 2 (plug) must always be clean and greased with mounting grease. After the repeated use the O-ring should be replaced.

This applies to the item-no.:

4114191  
4114192  
4114193  
4114206  
4114206  
4114208  
4114212  
4114213  
4114214

**Detailed information regarding the different dimensions of the sprinkler outlet please take from tables on pages 21 and 22!**

**Colour of plastic sleeve may differ.**

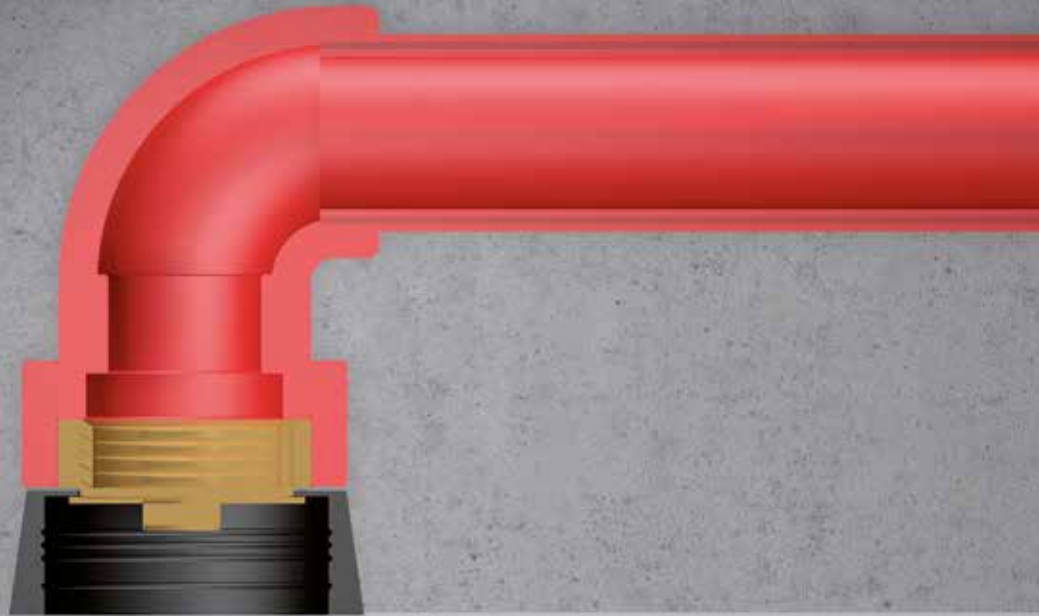

**Picture 2**

### LAYING OF **AQUATHERM RED PIPE** IN THE CONCRETE

The aquatherm red pipe sprinkler connection is finished (picture 2).

When removing the shuttering (after pouring of the concrete), the base part of the sprinkler outlet (1) is pulled out of the upper part of the sprinkler outlet (3).

The brass plug (2) is unscrewed from the aquatherm red pipe connection piece (part 4). Now, the upper part of sprinkler outlet (3) must be pulled out of the concrete easily with the aquatherm red pipe extraction tool (Art. no. 50290).

The sprinkler connection (picture 3) can be completed very easily. The, acc. to CEA 4001, required distance from the sprinkler head to the completed ceiling, can be accomplished with the compensating fitting from the sprinkler connection thread up to the aquatherm red pipe connecting piece (see drawing page 56).

**Picture 3**



LAYING OF **AQUATHERM RED PIPE** IN THE CONCRETE

Sprinkler outlet consists of the base part, upper part and plug.

For the distance from the deflector to the ceiling, refer to the CEA-4001. You will find compensating joints on page 23.

For further information on the sprinkler outlets please see the tables on pages 21 and 22.

It has to be ensured that the aquatherm red pipe is covered above and below by a minimum 60 mm layer concrete layer.

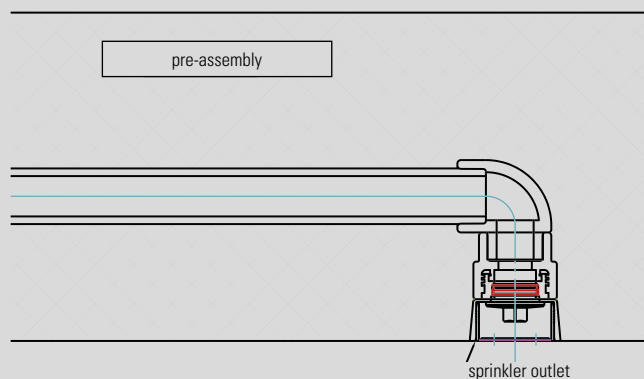

Visible sprinkler

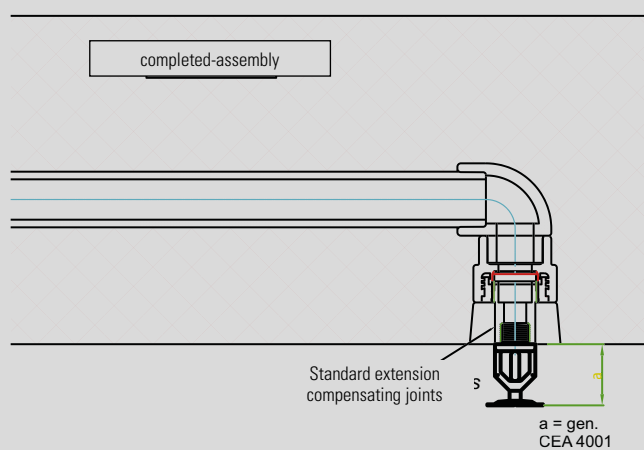

Covered sprinkler

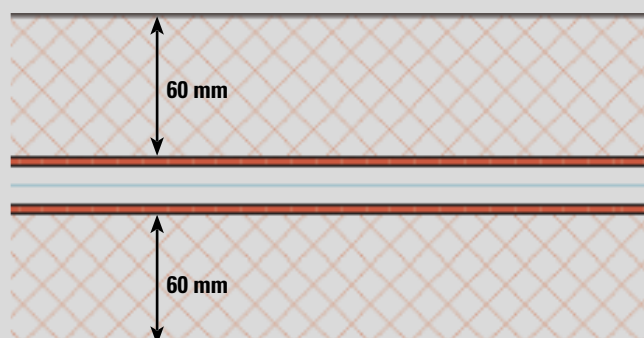
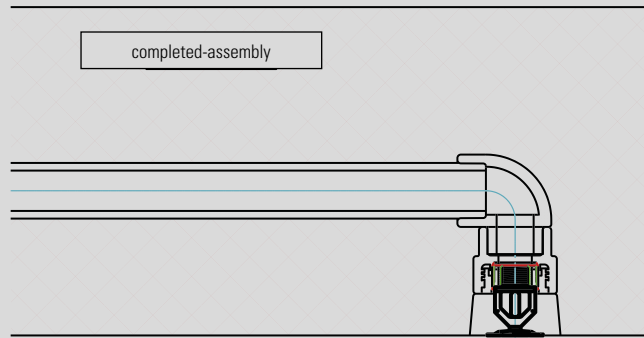

## aquatherm red pipe COMPENSATING JOINT AND ADJUSTING TOOL

**Pipe system made of polypropylene**  
for sprinklers

Compensation joint for use with „aquatherm red pipe“, pipe system made of plastic, VdS approval number: G4050042

The specifications of the technical catalogue „aquatherm red pipe“ and the VdS CEA 4001 (Guidelines for sprinkler systems – planning and installation) are valid.

**Application:**

Correction of non-aligned sprinkler connections in concrete ceilings, maximum correction angle 15° and for compensation of the connection thread to the sprinkler thread (maximum 3 cm) in concrete ceilings, maximum operating pressure 18 bar.

**Important instructions:**

- The compensating joint may only be bent once – multiple reverse bending is not permitted
- Maximum tightening torque for sprinkler = 29 Nm
- Only for the direct connection of the sprinkler

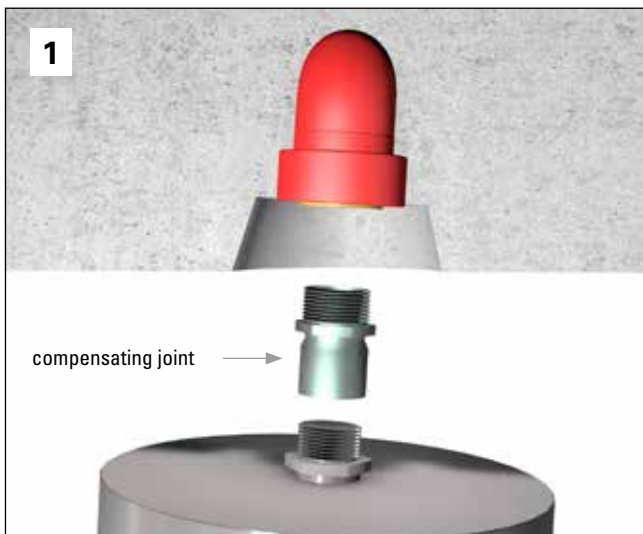

1) If the sprinkler connection protrudes obliquely from the concrete surface, it is possible to align this with the balancing connection. The balancing connection is installed with the provided hexagon in the sprinkler connection thread. A common sealing method for the preparation of waterproof threaded connections is to be used.

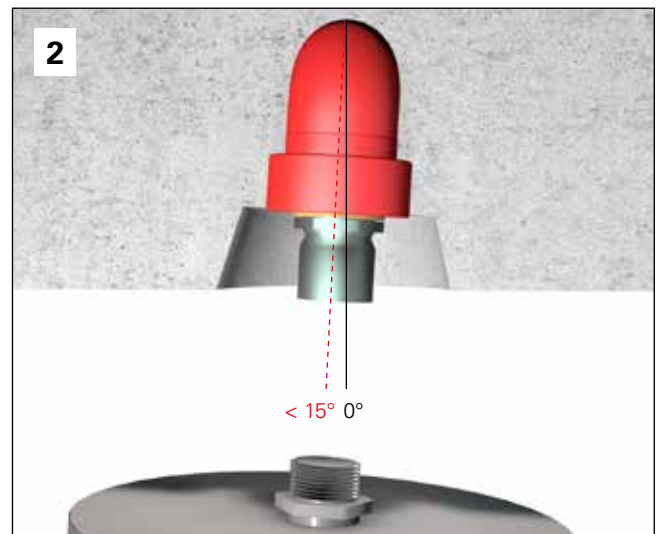

2) This requires a special adjusting tool. It is important to ensure that the bending radius is not more than 15°. The bearing surface of the female thread serves as a reference point on the surface.

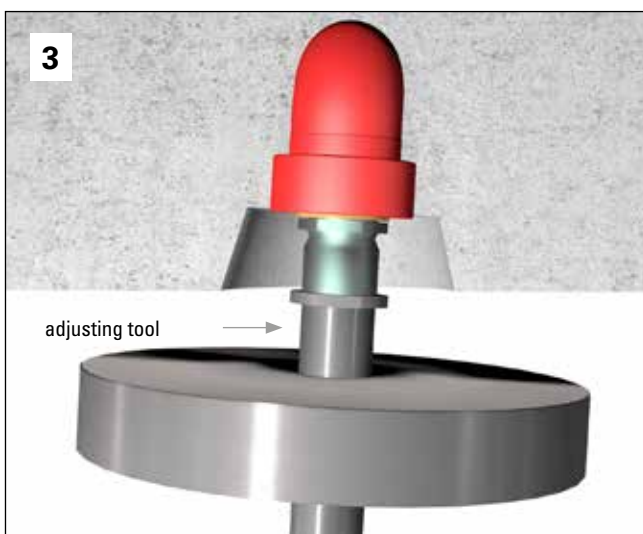

3) The adjusting tool is screwed into the balancing connection with the appropriate adapter.

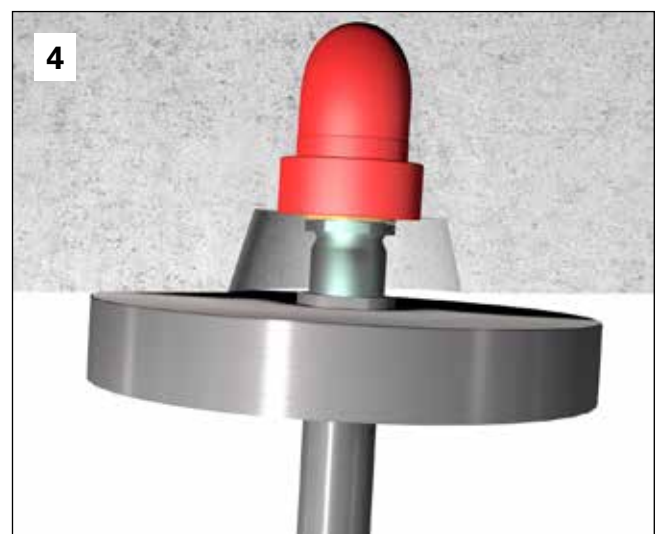

4) With gentle pressure by hand, the compensating joint is pushed into its position until the plate of the adjusting tool fits proper against the concrete surface.

**aquatherm red pipe COMPENSATING JOINT AND ADJUSTING TOOL**

**Pipe system made of polypropylene**  
for sprinklers

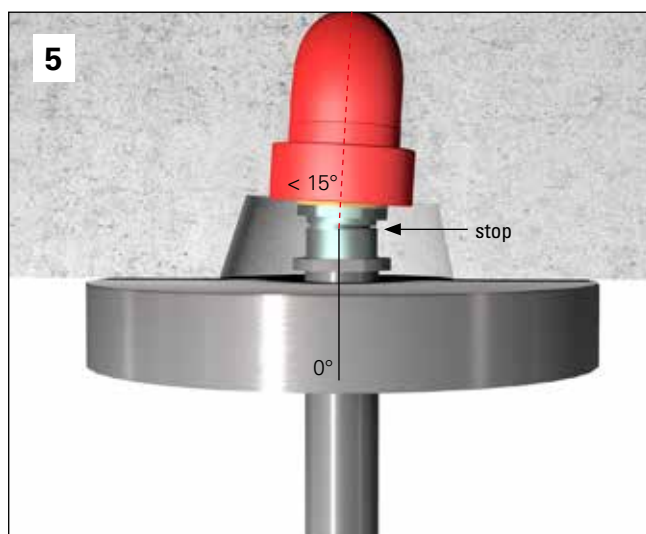

5) To check the perpendicularity, there is a level at the end of the handle. The stop limits the bending radius to 15°.

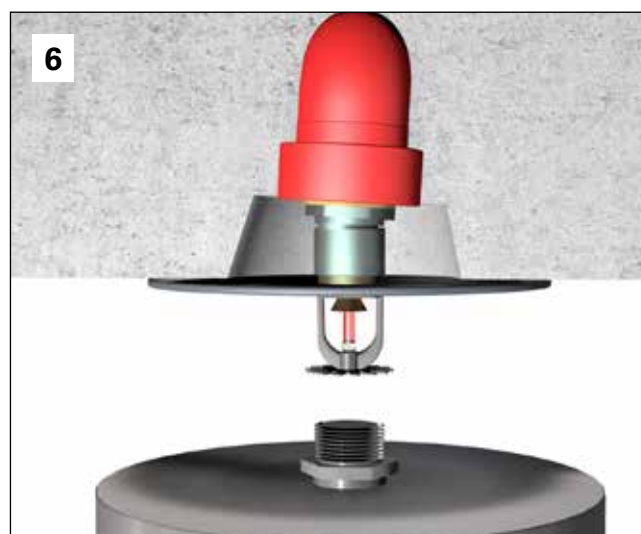

6.) When the sprinkler is installed, the sprinkler connection is subject to the pressure test as usual and tested for leaks. The maximum operating pressure is 18 bar.

Adjusting tool for balancing connection  
Compensating joint

page 34  
page 23

Art. no. 50291  
Art. no. 4114230  
Art. no. 4114232  
Art. no. 4114234  
Art. no. 4114236



LAYING OF **AQUATHERM RED PIPE** IN THE CONCRETE

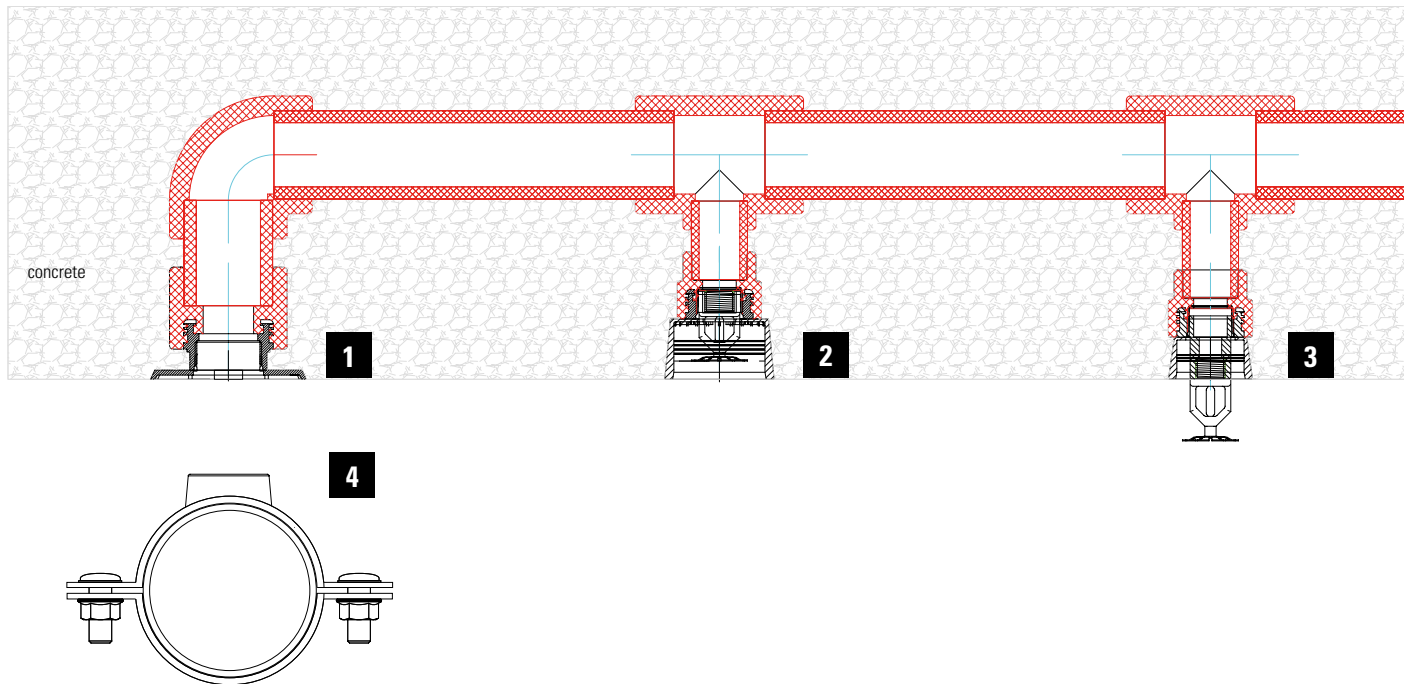

- 1** aquatherm red pipe outlet  
1 1/4", 1 1/2" and 2"
- 2** aquatherm red pipe sprinkler outlet  
for covered sprinkler  
1/2", 3/4" and 1"
- 3** aquatherm red pipe sprinkler outlet  
for visible sprinkler  
1/2", 3/4" and 1"
- 4** aquatherm red pipe to steel pipe adapter

**ATTENTION**

All upper parts of sprinkler outlet must be pulled out of the concrete with the aquatherm red pipe extraction tool (Art. no. 50290).



LAYING OF **AQUATHERM RED PIPE** IN THE CONCRETE**Description of the installation in prefabricated concrete ceiling (Filigree ceiling)****Introduction:**

Because precast concrete products are directly shuttered and processed at factory, there remain only some working steps at site. A slab formwork on site is not required. The rapid laying and on-site-installation saves time and costs. Due to the very smooth soffit by the steel formwork table, a plastering is not necessary.

If an installation system is mounted on the steel formwork, this must work precisely, safely and quickly.

The sprinkler outlet of the sprinkler pipe system aquatherm red pipe can be easily mounted on steel formwork. The entire component is assembled in advance by an installation company and delivered to the concrete plant.

In the concrete plant, the sprinkler outlets are measured on the steel formwork and mounted.

**Assembly:**

The base part of the sprinkler outlet is fixed with a magnet (min. holding force 23 kg), or with a hot-melt adhesive (temperature 100 °C) to the steel formwork with reinforcement and also keeps the position during vibrations.

The length of the pipe connecting piece has to be dimensioned so that it is protected by the projecting reinforcement on the transport to the site. The pipe connecting piece is protected by a protective cap and adhesive tape, thereby preventing the penetration of concrete into the interior of the pipe during filling of the mold.



Base part of sprinkler outlet Art. no. 4114180 for visible sprinklers. Attachment by magnet.



Base part of sprinkler outlet Art. no. 4114190 for concealed sprinklers. Attachment with hot-melt adhesive.



The upper part of the sprinkler outlet with pipe connection is attached to the base part of the sprinkler outlet.



1. Type of connection: visible sprinkler      2. Type of connection: concealed sprinkler

LAYING OF **AQUATHERM RED PIPE** IN THE CONCRETE

**Description of the installation in prefabricated concrete ceiling (Filigree ceiling)**

**Assembly:**

The mold is filled with concrete and vibrated simultaneously. After shaking the concrete surface is roughened. The component is to dry in a drying chamber.

After drying, the ceiling component is transported to the site and assembled. An installation company can now connect the sprinkler connections with each other and connect them to the supply pipe.

Thus, this method of prefabrication allows shorter construction periods and larger areas. This results in a cost reduction on the one hand and some more flexibility – all in all an increase of economy.







LAYING OF **AQUATHERM RED PIPE** IN THE CONCRETE

**Part 2:**

**Pressure test of pipe work installation as strength test and leak test**

Please refer to the information on page 63–65.

**Part 3:**

**What must be considered during the concreting process?**

All sprinkler connections have to be locked with cable clips (picture 1) and to underpin (picture 2).

Pipes and sprinkler connections must be fitted with suitable material (see fig. 1) in order to avoid bending. The sprinkler connection (sprinkler outlet) must be in the correct position. If necessary, this should be aligned and re-fastened before concreting.

The pipe sections must be fixed every 1.5 to 2 m in a way (using pipe hangers or lacing cord) to avoid sagging or bowing during the concreting process. It is important, that the pipe work is completely embedded without any hollow spaces (cavities).

The entering of the pipes during the concreting process must be avoided. The compacting of the concrete with concrete vibrators in the pipe area should be carried out carefully. Impacts, especially at low temperatures (below +5 °C) must be avoided.

Open pipes and connections must be closed before the concreting.

LAYING OF **AQUATHERM RED PIPE** IN THE CONCRETE

**Part 4:**

**Access to connection of the pipe work in concrete**

**Option 1:**

The pipe work in the concrete should be connected to the supply pipe, that the connection can be accessed in case of damage.

This may accomplished as follows: Before applying the concrete on the ceiling, a form work (casing) should be constructed around the connection (allow enough space for installation work). The connection is embedded in sand or similar fill of F90-quality in the form work.

The ceiling can be filled with concrete now. After striking the ceiling, the connection can be laid open and is now accessible. The subsequent sealing of the cavity in the ceiling can be made with elements of F90-quality. The access must be visible at all times (indicated on the drawing or by marking the ceiling).

**Option 2:**

Before casting the connection can be packed in a Rockwool-fire protection panel Conlit 150 U (allow enough space for installation work).

**This panel has the following features:**

light, water-repellent, pressure-resistant, self-supporting rockwool panel covered with glass grid

**Fields of application:**

fire protection covering for steel construction F30–A-F180-A, Increase of fire resistance class of concrete coverings.

Not flammable A2 acc. to DIN 4102, Part 1. Melting point > 1000 °C.

After shuttering of the ceilings, the fire protection panel Conlit 150 U can remain in the completed ceiling and can be adjusted to the structure of the concrete ceiling by plastering.

The access shall be visible, as in option 1, at all time.

**Drawing according to options 1 and 2**

**Drawing according to options 1 and 2**

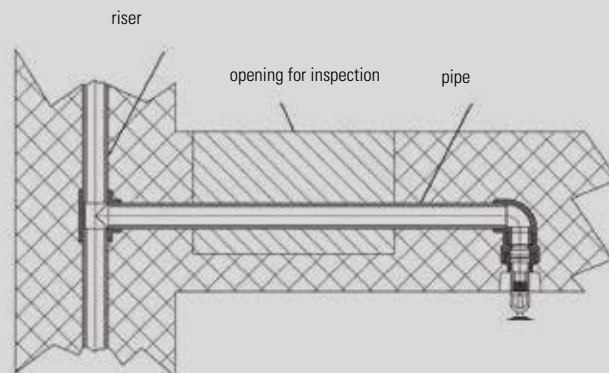

## LAYING OF **AQUATHERM RED PIPE** IN THE CONCRETE

### **Damaged pipe work in concrete, e.g. by drilling work**

Damaged pipe work can be repaired by fusion welding (see aquatherm red pipe sprinkler system, Part B).

The aquatherm red pipe system can also be repaired using the pipe repair stick (see aquatherm red pipe sprinkler system, Part F).

### **Part 5:**

#### **Bridging of expansion joints**

The expansion of aquatherm red pipe pipes depends on the temperature of the pipe material. Cold water supplies cause hardly any expansion for a normal assembly nor do normal outside temperatures.

The expansion need not to be considered when laying aquatherm red pipe in the concrete. Rising pressures- and tensile stresses are not critical, as they are absorbed by the material.

However, if it is necessary to bridge the expansion joints, the aquatherm red pipes must be equipped with an approx. 25 cm protection pipe at both ends of the joint.

A confirmation of the responsible architect resp. structural designer must certify that no lengthwise movements in the expansion joints can be expected.

Bridging of building joints is not permitted.

The coefficient of expansion of aquatherm red pipe pipes is 0.035 mm/mK  
The coefficient of expansion of concrete is 0.05–0.12 mm/mK.

### **Part 6:**

#### **Potential equalizing**

The VDE 0190 Part 410 and 540 requires a potential equalizing between all kinds of earth conductors and the existing "conductible" potable and waste water supplies and heating pipes. As aquatherm red pipe is not a conductible pipe system, it cannot be used for potential equalizing and thus needs no earth wiring.

The potential equalizing is made according to VDE-standard from the building parts, which have to be earth wired, directly to the potential equalizing rail to the planned position. The constructor or site manager must advise the client or his representative, that an approved electrician must check, if the aquatherm red pipe installation does not affect the existing electrical protection and earth wiring measurements (VOB Part C, general-technical conditions of contract ATV).

### **Part 7:**

#### **Pressurizing in the aquatherm red pipe supply during the concreting process**

During the concreting process the pipe must be pressurized with the admissible operating pressure, so that a damaged point is visible at once.

After the pressure test the admissible operating pressure is kept by shut off of the respective pipe. The applied measuring devices must grant a correct reading of pressure changes of 0.1 bar.

The pressure measuring device shall be installed at the deepest point of the pipe system.

### **Part 8:**

#### **Influence of the concrete on the applied compounds**

The aquatherm red pipe pipe system contains all required compounds for a complete system installation. Mixed installation with non-system and/or non-material compounds are not required.

All material is resistant to corrosion. The threads of the aquatherm red pipe sprinkler connection fittings are made from brass (CuZn36Pb2As).

Experiences with this material confirm that the alloy has an excellent resistance against concrete.

The general building regulations have to be complied with locally. If special chemical additives (retarder etc.) are applied, information from the manufacturer of the concrete should be gathered; refer to aquatherm for suitability.

## LEAKAGE TEST

All sprinkler pipelines shall be subjected to a hydraulic pressure test with a test-pressure of 10 bar.

The material properties of the aquatherm red pipes result in an expansion of the pipes during the pressure test. This affects the test result. Due to the thermal expansion coefficients of the aquatherm red pipes the results are influenced additionally. The temperature differences between the pipe and the test medium lead to changes in pressure. Hereby a temperature change of 10 K corresponds to a pressure difference of 0,5 up to 1 bar.

Therefore, pressure testing of the aquatherm red pipe systems should be made with a constant temperature of the test medium. The hydraulic pressure test requires a preliminary, principal and final test.

In the preliminary test a pressure of 18 bar is applied 3 x 5 minutes for the expansion/release of the pipes. Between the cycles the pipe system must be depressurized.

Immediately after the preliminary test the principal test should be performed. The test duration is 15 min. Here, the test pressure (10 bar) may not fall more than 0,5 bar.

After completion of the preliminary and principle test finally the final test must be performed.

The test duration is 60 minutes. Here, the test pressure – read after the principle test – may not fall more than 0,5 bar.

### Measuring of the test pressures

Measuring has to be done with a manometer allowing a perfect reading of a pressure change of 0.1 bar. The manometer has to be placed at the deepest point of the installation.

### Test record

A record of the hydraulic pressure test has to be prepared and signed by the client and contractor stating place and date (see pages 64/65).

**LEAKAGE TEST/PRESURE DIAGRAM****PRELIMINARY TEST**

Working pressure

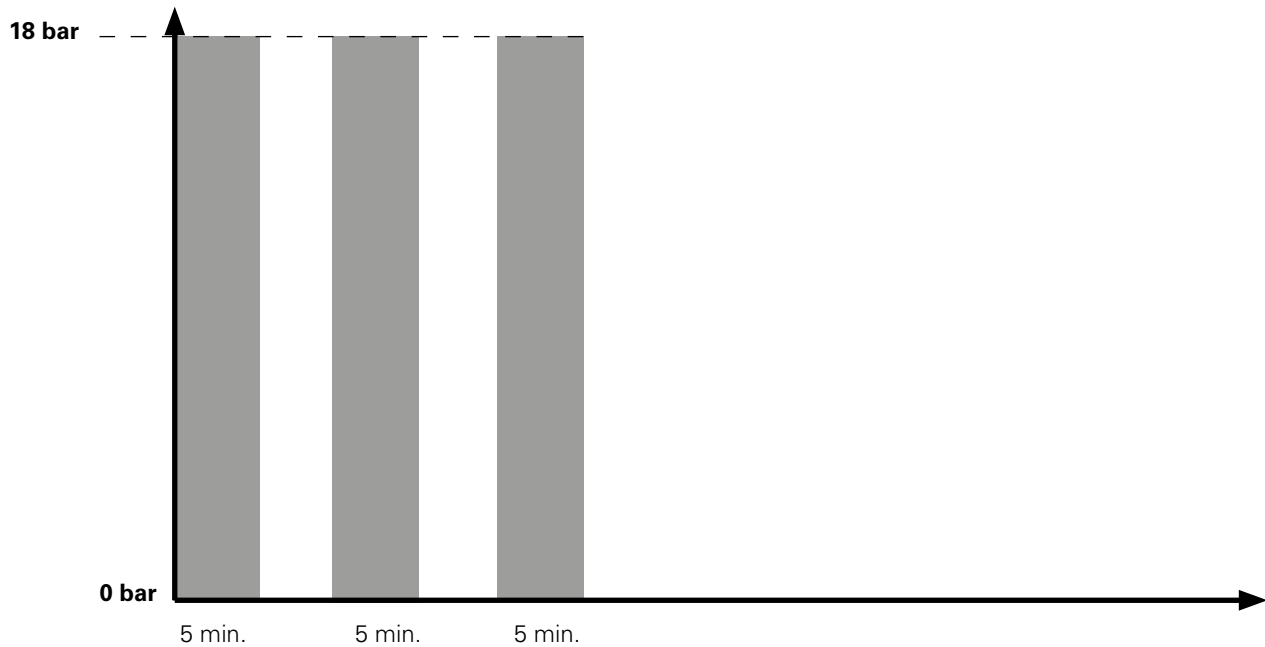
**PRINCIPAL- AND FINAL TEST**

Working pressure

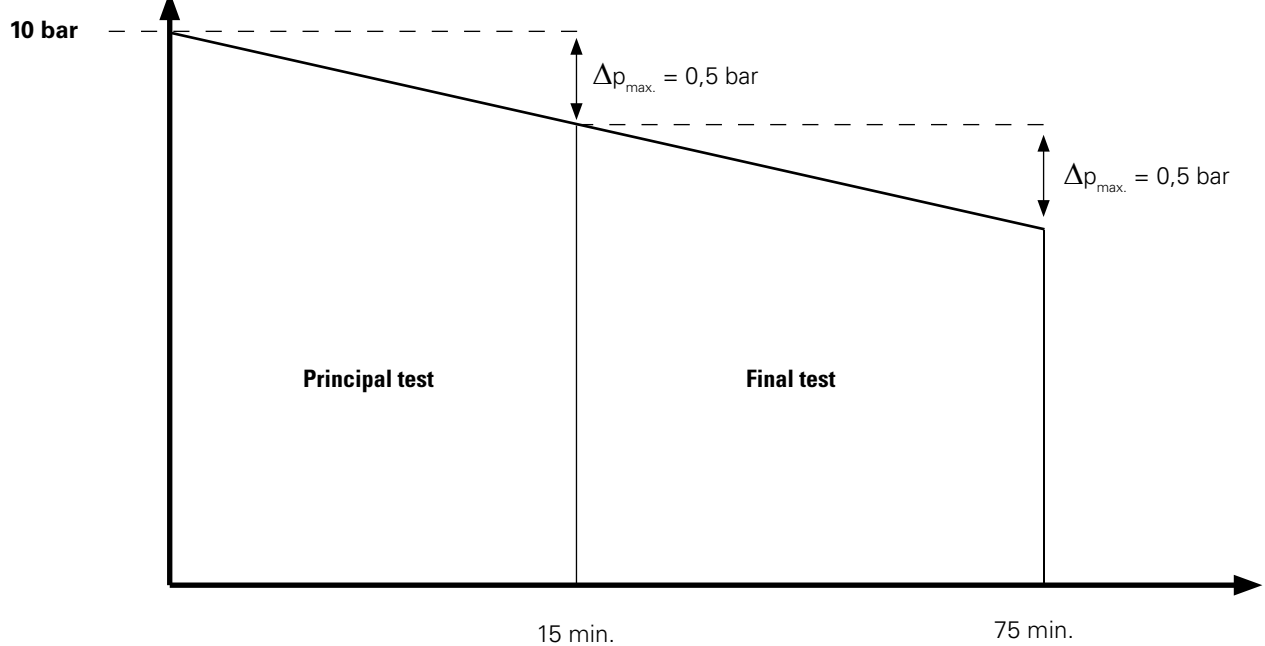

### TEST RECORD AQUATHERM RED PIPE SYSTEM INSTALLATION

#### Test record aquatherm system installation

Place: \_\_\_\_\_

Object: \_\_\_\_\_

#### Note before the test:

3x 5 minutes system pressure of 18 bar for expansion/release of the pipes are required.

#### Preliminary test

The pipe system must be unpressurized between each cycle.

<b>18 bar</b>	5 min.	realized:	yes	no
<b>18 bar</b>	5 min.	realized:	yes	no
<b>18 bar</b>	5 min.	realized:	yes	no

#### Principal test

Test pressure: \_\_\_\_\_ 10 \_\_\_\_\_ bar

Pressure decline after 15 min.: \_\_\_\_\_ bar **max. 0,5 bar**

#### Final test

(directly after the principal test, without changing the pressure)

Result principal test: \_\_\_\_\_ bar

Pressure decline after 60 min.: \_\_\_\_\_ bar **max. 0,5 bar**

Notes: \_\_\_\_\_  
\_\_\_\_\_  
\_\_\_\_\_

Place: \_\_\_\_\_

Date: \_\_\_\_\_

\_\_\_\_\_  
**Stamp/Signature**



**Description of installation**

Place: \_\_\_\_\_

Object: \_\_\_\_\_

**Pipe length:**

Ø 20 mm \_\_\_\_\_ m  
Ø 25 mm \_\_\_\_\_ m  
Ø 32 mm \_\_\_\_\_ m  
Ø 40 mm \_\_\_\_\_ m  
Ø 50 mm \_\_\_\_\_ m  
Ø 63 mm \_\_\_\_\_ m  
Ø 75 mm \_\_\_\_\_ m  
Ø 90 mm \_\_\_\_\_ m  
Ø 125 mm \_\_\_\_\_ m  
Ø 160 mm \_\_\_\_\_ m

Start of test: \_\_\_\_\_

End of test: \_\_\_\_\_

Testperiod: \_\_\_\_\_

Test medium:       water       water/glycol

Client: \_\_\_\_\_

\_\_\_\_\_

\_\_\_\_\_

Contractor: \_\_\_\_\_

\_\_\_\_\_

\_\_\_\_\_

Place: \_\_\_\_\_

Date: \_\_\_\_\_

\_\_\_\_\_  
**Stamp/Signature**

**AQUATHERM RED PIPE SYSTEM**

Enquiry for the chemical resistance

**Enquiry for the chemical resistance of the aquatherm red pipe pipe system**

**aquatherm GmbH**

**Technical department**

Biggen 5 · D-57439 Attendorn

Phone: 02722 950-0 · Fax: 02722 950-100

E-mail: info@aquatherm.de

Internet: www.aquatherm.de

**Installer:**

**Field of application:**

**Installer**

**Fluid transported:**

Company \_\_\_\_\_

Street \_\_\_\_\_

City \_\_\_\_\_

Phone \_\_\_\_\_

Fax \_\_\_\_\_

E-mail \_\_\_\_\_

Operating temperature \_\_\_\_\_ °C

Working pressure \_\_\_\_\_ bar

Service life \_\_\_\_\_ h/d

Concentration \_\_\_\_\_ %

**Building project:**

**Ambient medium:**

\_\_\_\_\_

\_\_\_\_\_

\_\_\_\_\_

Ambient temperature \_\_\_\_\_ °C

Ambient pressure \_\_\_\_\_ bar

**Building project:**

Street \_\_\_\_\_

City \_\_\_\_\_

Place, Date / Signature \_\_\_\_\_

Data sheets	enclosed	not enclosed
Fluid transported	<input type="checkbox"/>	<input type="checkbox"/>
Ambient medium	<input type="checkbox"/>	<input type="checkbox"/>

**REFERENCES****Office Building "Römischer Hof"**

Berlin, Germany

**Spiegel Building**

Hamburg, Germany

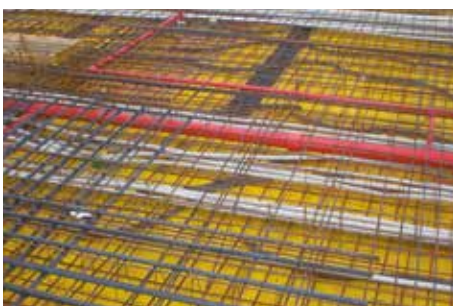



**REFERENCES**

**The European Patent Office**

Munich, Germany





**REFERENCES****Public services munich, technology center**

Munich, Germany





REFERENCES

**HYP0-Center**

Innsbruck, Austria



Foto: Hypo Tirol Bank AG





## REFERENCES

## Raschal-Centre for children surgery and traumatology

Moscow, Russia



**REFERENCES**

**Shopping Centre**

Moscow, Russia



**Office Building**

Moscow, Russia





## REFERENCES

## Hotel

Sweden



## CARPET WAREHOUSE

Turkey



**REFERENCES**

**Pandion Vista, luxury apartments**

Cologne, Germany





## REFERENCES

**AachenMünchener Insurance**

Aachen, Germany

**Federal Archives**

Berlin, Germany

**Unionsbräu**

Dortmund, Germany





**REFERENCES**

**Coffee Plaza**

Hamburg Hafencity, Germany

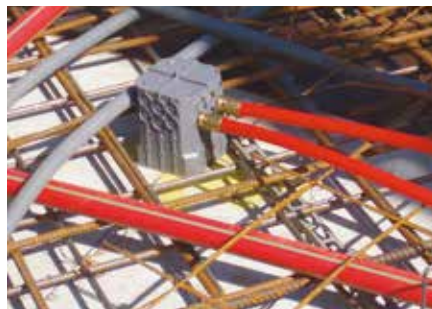

**Upper West**

Berlin, Germany

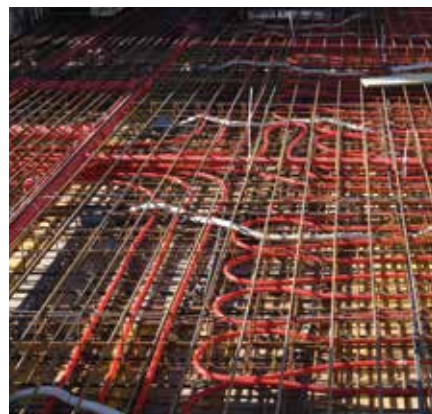



**REFERENCES****Dornier Museum**

Friedrichshafen, Germany

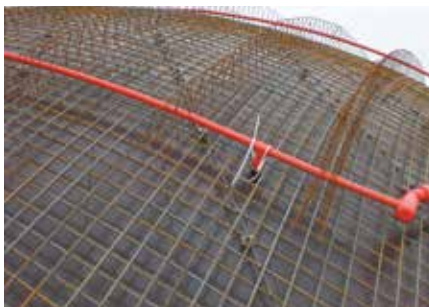
**Metropolis**

Hamburg, Germany





REFERENCES

Hans Sachs Building

Gelsenkirchen, Germany

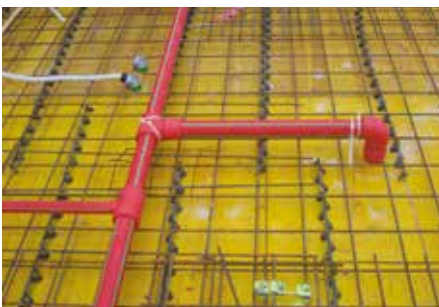
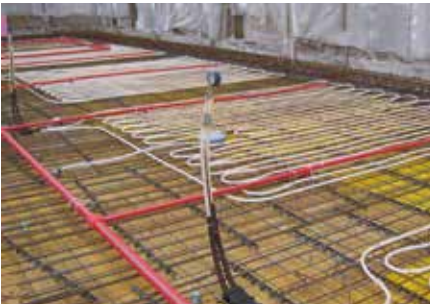



**REFERENCES**

**Central office HDI-Gerling Insurance**

Hannover, Germany





**REFERENCES**

**Crystalbuilding**

Hamburg fish market, Germany





## REFERENCES

**Office building Rödingsmarkt**

Hamburg, Germany

**Überseequartier**

Hamburg, Germany





**REFERENCES**

**Kö-Bogen, shopping and event center**

Düsseldorf, Germany





REFERENCES

**GEWA Tower**

Fellbach, Germany



**aquatherm factory**

Attendorf, Germany



Assembly precast concrete ceiling



Prefabrication concrete wall

**REFERENCES**

**Tanzende Türme**

Hamburg, Germany

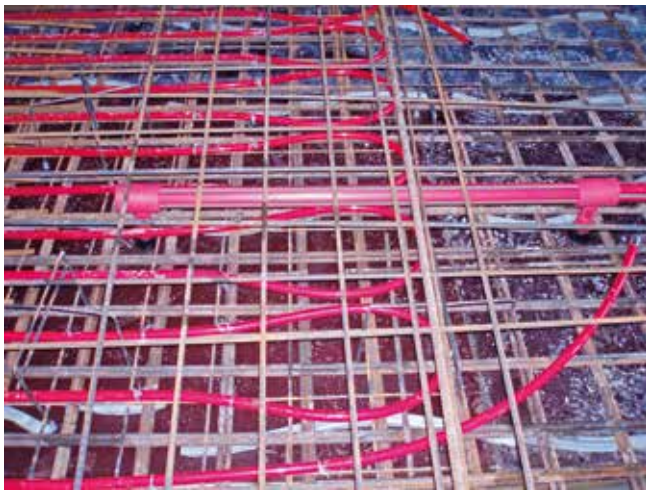
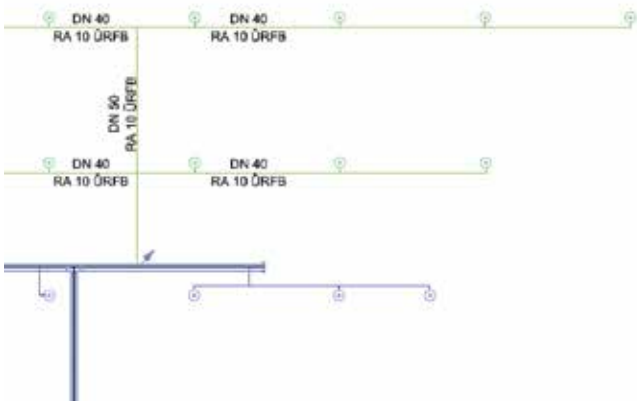

**Schwabinger Tor**

Munich, Germany







Management  
System  
ISO 9001:2008  
ISO 14001:2004  
ISO 50001:2011  
[www.tuv.com](http://www.tuv.com)  
ID 0091005348

## aquatherm GmbH

Biggen 5 | D-57439 Attendorn | Phone: +49 (0) 2722 950-0 | Fax: +49 (0) 2722 950-100  
[info@aquatherm.de](mailto:info@aquatherm.de) [www.aquatherm.de](http://www.aquatherm.de)

Order-No.: E40000  
Edition: 2.2017