

12410160001

D985 |10| ZPL HX LCKNT/INS M16

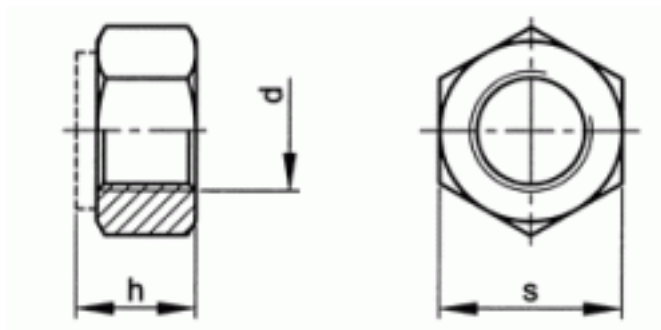

Brand	-
UBB Code	950355543105
UNSPSC Code	31161727
EAN Code	8715492578549
Driving features	hexagon
Thread	Metric thread
Class	10
Material	Steel
Surface treatment	Zinc plated



s	23
h	16
P	2
d	M16
Packaging (Piece )	50.0



Copyright Fabory Group