







# IS 2360-3 ECO 24m

white  
 EAN 4007841 057770  
 Article number 057770



		2000 W					5 years	
infrared sensor 360°	max. 12 m	2000 W max. (LED-ready)	IP54	2 - 1000 lux	5 sec - 15 min	energy saving	manufacturer's warranty steinel-professional.de/garantie	CE

## Function description

The multi-talent for indoors and outdoors. Infrared wall sensor IS 2360-3 ECO, 3 pyro sensors for a 360° angle of coverage, reach can be set up to 12 m, selectable time and twilight threshold, detection zone can be customised with shrouds.

## Technical specifications

Dimensions (Ø x H)	121 x 57 mm	LED lamps < 2 W	100 W
With motion detector	Yes	LED lamps > 2 W < 8 W	300 W
Manufacturer's Warranty	5 years	LED lamps > 8 W	600 W
Settings via	Potentiometers	Capacitive load in µF	176 µF
With remote control	No	Power consumption	0,56 W
Version	white	Technology, sensors	passive infrared, Light sensor
PU1, EAN	4007841057770	Mounting height	2,50 – 6,00 m
Type	Motion detectors	Mounting height max.	6,00 m
Application, place	Outdoors, Indoors	Optimum mounting height	2,8 m
Application, room	corridor / aisle, changing room, function room / ancillary room, kitchenette, stairwell, WC / washroom, multi-storey / underground car park, outdoors, warehouse, Indoors	Detection angle	360 °
Colour	white	Angle of aperture	90 °
Colour, RAL	9010	Sneak-by guard	Yes
Includes corner wall mount	No	Capability of masking out individual segments	Yes
Installation site	ceiling	Electronic scalability	No
		Mechanical scalability	No
		Reach, radial	Ø 6 m (28 m <sup>2</sup> )
		Reach, tangential	Ø 24 m (452 m <sup>2</sup> )

# IS 2360-3 ECO 24m

white  
 EAN 4007841 057770  
 Article number 057770



## Technical specifications

Installation	Surface wiring, Ceiling
IP-rating	IP54
Protection class	II
Ambient temperature	-20 – 50 °C
Material	Plastic
Mains power supply	220 – 240 V / 50 – 60 Hz
Switching output 1, resistive	2000 W
Switching output 1, number of LEDs / fluorescent lamps	8 pcs.
Switching output 1, floating	No
Fluorescent lamps, electronic ballast	1500 W
Fluorescent lamps, uncorrected	500 VA
Fluorescent lamps, series-corrected	900 VA
Fluorescent lamps, parallel-corrected	400 VA
Switching output 1, low-voltage halogen lamps	2000 VA

Switching zones	972 switching zones
Cover material	shrouds
Twilight setting	2 – 1000 lx
Time setting	5 s – 15 Min.
Basic light level function	No
Main light adjustable	No
Twilight setting TEACH	No
Constant-lighting control	No
Interconnection	Yes
Type of interconnection	Master/master
Interconnection via	Cable

# IS 2360-3 ECO 24m

white  
EAN 4007841 057770  
Article number 057770

## Detection Zone

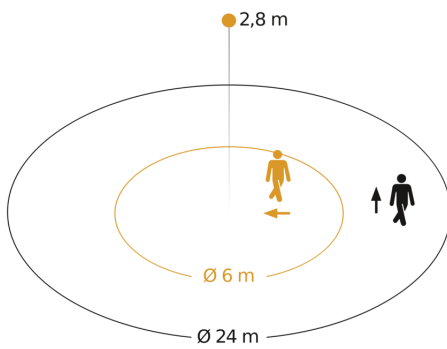

Possible mounting height: 2,50 m – 6,00 m  
Orange: radial  
Black: tangential

## Dimension Drawing

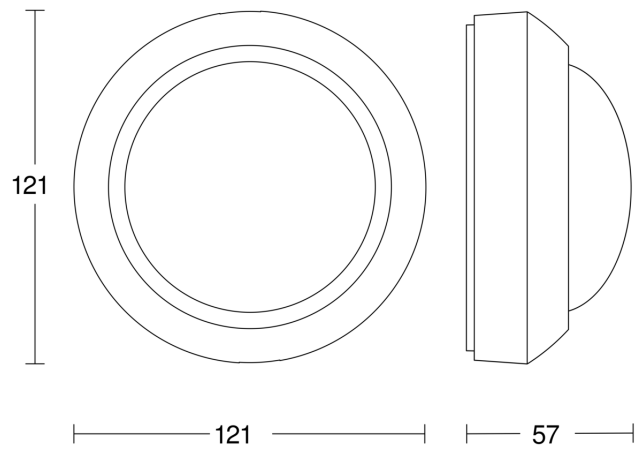

## Circuit diagram

